

87-319-08
Replaces 87-310-06

2008 Edition

ALTERNATORS & STARTERS

*Farm, Industrial,
& Truck*



WPS

WORLD POWER SYSTEMS

21SI, 22SI ALTERNATOR FEATURES



- 100% New
- WAI-Transpo premium rectifier & regulator
- Premium, hi-temperature WBD 6305 bearing
 - Long-shaft rotor & longer needle bearing provides more bearing surface to spread the load for longer lasting service
- 1/4-20 thru bolts used on 21SI - larger than OE 10-24 bolts
- Rotor coil leads are epoxied to prevent vibration failure
- Hi-temperature class-H windings
- Precision CNC machined castings
- OE performance output curve
- Universal R-terminal - designed by WAI, features both pin type & 10-24 threaded connection

40MT, 42MT STARTER FEATURES

- 100% New
- Available with Zen Maxitork Drive
- Armature with heat treated shaft and welded steel-core riserless commutator
- Varnish dipped field coils
- Ductile iron D.E. housing
- Solenoids are 100% tested for coil strength, voltage drop across contacts and 'reserve burnoff' on the contacts
- Painted gloss black with zinc plated hardware
- 100% computerized load tested



37MT POSITIVE ENGAGEMENT STARTER FEATURES

- 100% New
 - 41MT Maxitork, positive-engagement drive
 - 41MT heat treated armature with straight splines and welded steel core riserless commutator
 - 41MT solenoid, 100% tested for coil strength, voltage drop across contacts and 'reserve burnoff' on the contacts
- Varnish dipped field coils
- Ductile iron D.E. housing
- Painted gloss black with zinc-yellow plated hardware
- 100% computerized load tested
- Eliminates the stop ring & stop collar failure common on the 37MT design



TABLE OF CONTENTS

HEAVY DUTY & OFF ROAD

Bosch 1

| | |
|-----------------------|---|
| Alternators | 1 |
| Starters. | 4 |

Delco 9

| | |
|--------------------------------------|----|
| Alternators | 9 |
| 7SI Series. | 9 |
| 10DN Series. | 9 |
| 10SI Series. | 9 |
| 12SI Series. | 10 |
| 15SI Series. | 10 |
| 17SI Series. | 10 |
| 19SI Series. | 11 |
| 20SI Series. | 11 |
| 21SI Series. | 11 |
| 22SI Series. | 14 |
| 22SI Series Oval Plug | 16 |
| 23SI Series. | 16 |
| 24SI Series. | 16 |
| 25SI Series. | 16 |
| 26SI Series. | 17 |
| 27SI/200 Series | 17 |
| 30SI Series. | 18 |
| 31SI Series. | 19 |
| 33SI Series. | 19 |
| 34SI Series. | 20 |
| 35SI HP Series | 20 |
| AD230 Series | 21 |
| AD244 Series | 22 |
| CS130 Series. | 22 |
| CS130D Series | 25 |
| CS144 Series. | 27 |
| DR44G Series | 28 |
| Starters. | 28 |
| 14MT Series. | 28 |
| 27MT Series. | 28 |
| 28MT Series. | 29 |
| 29MT Series. | 34 |
| 37MT Series. | 34 |
| 38MT Series. | 37 |
| 39MT Series. | 37 |
| 40MT Series. | 40 |
| 41MT Series. | 41 |
| 42MT Series. | 41 |
| 50MT Series. | 43 |
| 6V Early DD (Direct Drive) | 43 |
| PG260 Series. | 44 |
| SD200, SD250 (5MT) Series | 47 |
| SD205, SD255 Series | 47 |
| SD260 Series. | 47 |
| SD300 (10MT) Series. | 47 |

Electroprecizia 49

Ford 49

| | |
|--|----|
| Alternators | 49 |
| 1G (ER/EF) | 49 |
| 2G (IR/EF) | 50 |
| 3G (IR/IF) | 52 |
| 6G (IR/IF) | 57 |
| Generators | 60 |
| Starters. | 60 |
| 4" MOD II. | 60 |
| 4½" | 60 |
| 6V Early DD (Direct Drive) | 61 |
| OSGR (Offset Gear Reduction) | 61 |
| PMGR (Perm. Magnet Gear Reduction) | 62 |

Hitachi 64

| | |
|-----------------------|----|
| Alternators | 64 |
| Starters. | 68 |

Iskra 73

Leece-Neville 73

Leece-Neville/Motorola 75

Lucas 76

Mando 82

Mitsubishi 83

| | |
|-----------------------|----|
| Alternators | 83 |
| Starters. | 85 |

Nikko 93

Nippondenso 94

| | |
|-----------------------|-----|
| Alternators | 94 |
| Starters. | 100 |

Prestolite 111

Valeo 112

POWER EQUIPMENT 113

| | |
|--|-----|
| DC Motors | 113 |
| Compressor Starting Motor | 113 |
| Pump Motors 12V | 113 |
| Pump Motors, 24V. | 118 |
| Snow Plow & Salt Spreader Motors | 119 |
| Winch Motors | 121 |

CROSS REFERENCE

| | |
|----------------------------|-----|
| Mfr# to Catalog# | 125 |
|----------------------------|-----|

NUMERICAL INDEX

| | |
|-----------------------------|-----|
| Catalog# to Page# | 207 |
|-----------------------------|-----|

ABBREVIATIONS

| | | | |
|-------------------|---|-------------------|--|
| Adj. | Adjusting | MD | Mando |
| Alt. | Alternator | Mfd. | Manufactured |
| Amp | Ampere | MI | Mitsubishi |
| Assy. | Assembly | MM | Magneti-Marelli |
| Assys. | Assemblies | mm | Millimeter |
| AT | Automatic Transmission | MO | Motorola |
| Batt. | Battery | MT | Mitsuba or Manual Transmission |
| BO | Bosch | mtd. | Mounted |
| Brg. | Bearing | Mtg. | Mounting |
| C.E. | Commutator End | NA. | Not Available |
| CCW | Counter Clockwise | ND | Nippondenso |
| CH | Chrysler | Ndl. | Needle |
| CJ. | Cajavec | NE. | Niehoff |
| Cont'd. | Continued | Neg. | Negative |
| CV. | CAV | NK. | Nikko |
| CW | Clockwise | No. | Number |
| D.E. | Drive End | Nos. | Numbers |
| Dbl. | Double | OAL | Overall Length |
| DD | Direct Drive | OCP | Overcrank Protection |
| Dia. | Diameter | OD | Outside Diameter |
| Dim. | Dimension | OE. | Original Equipment |
| DR. | Delco | OEM | Original Equipment Manufacturer |
| DU | Ducellier | Opt. | Option |
| ED. | External Driver | OSGR | Offset Gear Reduction |
| ED/IF. | External Driver and Internal Fan | PL | Prestolite |
| EF. | External Fan (cooling fan outside alternator casting) | PLGR | Planetary Gear Reduction |
| EL | Electrodyn | PMDD. | Permanent Magnet Direct Drive |
| Elec. | Electrical | PMGR. | Permanent Magnet Gear Reduction |
| ER. | External Regulated (regulator not part of alternator) | PMOSGR | Permanent Magnet Offset Gear Reduction |
| ER/EF. | External Regulated and External Fan | Pos. | Positive |
| ER/IF. | External Regulated and Internal Fan | PR. | Paris Rhone |
| Ext. | Extension or External | Prod. | Production |
| FD. | Ford | Ref. | Reference |
| Fld. | Field | Reg. | Regulator |
| Flg. | Flange | Req. | Required |
| FWD | Front Wheel Drive | R-Term. | Relay Terminal |
| Grd. | Ground | RWD | Rear Wheel Drive |
| Hi | High | sec. | Second |
| HI | Hitachi | Sgl. | Single |
| Hi-Temp | High Temperature | Soln. | Solenoid |
| HP. | Horse Power | SPL. | Spline |
| Hsg. | Housing | S-Term. | Switch Terminal |
| HT. | Height or High Torque | Str. | Starter |
| ID | Inside Diameter or Identification | Strs. | Starters |
| IF. | Internal Fan (cooling fan inside alternator casting) | SV. | SEV Marchal |
| IK | Iskra | Sys. | System |
| IMS. | Integral Magnetic Switch | T | Teeth, Thickness or Terminal |
| Incl. | Includes | Term. | Terminal |
| Int. | Internal | Terms. | Terminals |
| IR | Internal Regulated (regulator part of alternator) | Thd. | Thread |
| IR/EF. | Internal Regulated and External Fan | Thk. | Thick |
| IR/IF | Internal Regulated and Internal Fan | UT. | United Technologies |
| kW | Kilowatt | V | Volt or V-Belt |
| L | Length or Liter | VA. | Valeo |
| LH. | Lever Housing or Left Hand Side | Volt Set. | Voltage Setting |
| LN. | Leece-Neville | Vset | Voltage Setting |
| LRC | Load Response Control | W | Width |
| LU. | Lucas | w/ | With |
| MD | Mando | wo/ | Without |

Disclaimer:

While a concerted effort has been taken to ensure the accuracy of the part number cross reference, product selection shall be based upon purchasers' determination as to acceptability of form, fit and function. Care has been taken to ensure the accuracy of descriptions and applications of each item, but Wetherill Associates, Inc., assumes no responsibility for possible errors. Photos are intended for identification only and may not represent the specific part to be shipped. Units are remanufactured except where indicated 100% new.

Transpo, WAI and WPS are registered trademarks of Wetherill Associates, Inc. All other manufacturers' names used throughout this catalog are for application and identification purposes only with no intention to convey affiliation with their products.

BOSCH - ALTERNATORS

ER/IF (Ext. Reg./Int. Fan)

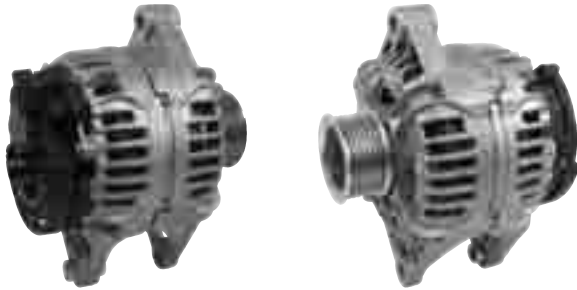

1-2225-01B0
(Ref# 13843N)

Alternator - Bosch ER/IF
117 Amp/12 Volt, CW, 7-Groove Pulley

Used On: (1999) Dodge Ram Pickup, Ram Van 3.9, 5.2, 5.9, 8.0L
Replaces: Bosch 6-004-MA5-001, Chrysler 56028237
Lester Nos: 13843
Note: For Nippondenso design use 1-2225-01ND-2 (Lester 13823).
Features: 100% New

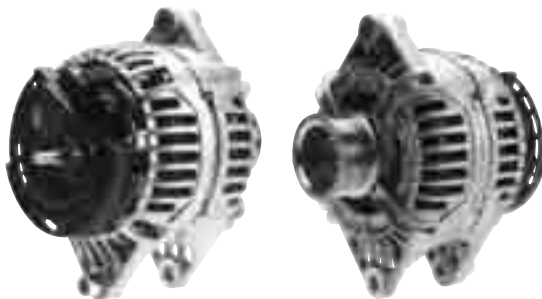

1-2227-02B0
(Ref# 13920N)

Alternator - Bosch ER/IF
136 Amp/12 Volt, CW, 7-Groove Pulley

Used On: (1999) Dodge B Series Van 3.9L, 5.2L, 5.9L (2000-99) Dodge Ram Pickup 3.9L, 5.2L, 5.9L, 8.0L
Replaces: Bosch 0-124-525-004, Chrysler 56028238
Lester Nos: 13920
Dim: M8 x 1.25 Batt. Term.
Features: 100% New



1-2526-01B0-2
(Ref# 13916N)

Alternator - Bosch ER/IF
132 Amp/12 Volt, CW, 6-Groove Pulley

Used On: (2006-04) Dodge Ram Pickup 3.7L, 4.7L
Replaces: Bosch 0-124-525-002, Chrysler 56041120AC
Lester Nos: 13916
Features: 100% New



1-2541-01B0
(Ref# 13917N)

Alternator - Bosch ER/IF
136 Amp/12 Volt, CW, 7-Groove Pulley

Used On: (2003-02) Dodge Ram Pickup 5.9L, 8.0L
Replaces: Bosch 0-124-525-007; Chrysler 56028560AA, 56029701AA; Nippondenso 421000-011
Lester Nos: 13914, 13917
Features: 100% New

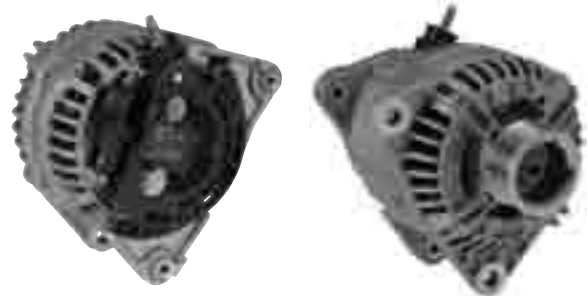

1-2553-01B0
(Ref# 13985N)

Alternator - Bosch ER/IF
136 Amp/12 Volt, CW, 7-Groove Pulley

Used On: (2006-03) Dodge Ram Pickup 5.7L
Replaces: Bosch 0-124-525-006, Chrysler 56028699AA
Lester Nos: 13985
Features: 100% New



1-2877-01B0

Alternator - Bosch ER/IF
136 Amp/12 Volt, CW, 8-Groove Pulley

Used On: (2005-03) Dodge Ram Pickup 5.9L (Diesel)
Replaces: Bosch 0-124-525-041, Chrysler 56028732AA
Lester Nos: 13987
Features: 100% New

HEAVY DUTY & OFF ROAD

HEAVY DUTY & OFF ROAD

BOSCH - ALTERNATORS

IR/EF (Int. Reg./Ext. Fan)

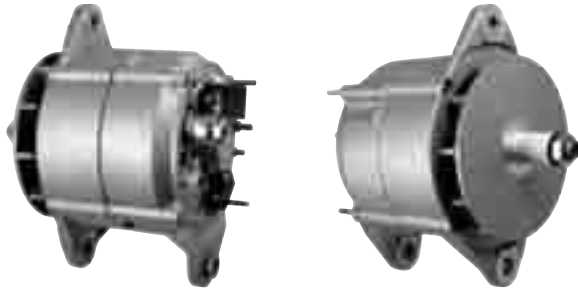

1-2045-01B0-2

(Ref# 12131N)

Alternator - Bosch IR/EF

110 Amp/12 Volt, CW

Used On: Case, International Ag & Industrial Equipment

Replaces: Bosch 0-120-468-028

Lester Nos: 12131

Features: 100% New



1-2237-00B0

(Ref# 12161N)

Alternator - Bosch IR/EF Replacement

65 Amp/12 Volt, CW

Used On: Atlas Copco, Case, Ingersoll Rand, Thermo King

Replaces: Bosch 0-120-488-205, Thermo King 44-8499

Lester Nos: 12161

Features: 100% New

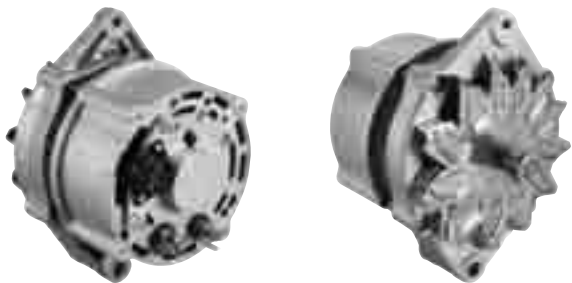

1-2344-00B0

(Ref# 12145N)

Alternator - Bosch IR/EF

95 Amp/12 Volt, wo/ Pulley

Used On: Case, Caterpillar, John Deere Farm & Industrial Equipment

Replaces: Bosch 0-120-484-011, -018, -026; Case A187623, Caterpillar 105-2813; John Deere AT220394, TY6750

Lester Nos: 12145

Features: 100% New

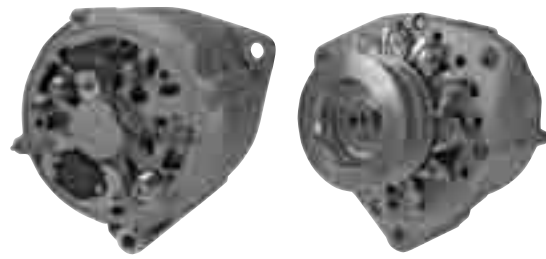

1-2711-01B0

(Ref# 68053N)

Alternator - Bosch IR/EF

80 Amp/24 Volt, CW, 2-Groove Pulley

Used On: DAF, MAN, Mercedes Buses, Trucks

Replaces: Bosch 0-120-468-053, -107, -113; DAF 91295; Iveco 8007700; KHD 1178511; Man 51-26101-7192, -7195, -9192; Mercedes 007-154-92-02, 007-154-99-02

Features: 100% New

1-2711-00B0

Alternator - Bosch IR/EF

Note: Same as 1-2711-01B0 except wo/ pulley

IR/IF (Int. Reg./Int. Fan)



1-2510-01B0

Alternator - Bosch IR/IF

130 Amp/12 Volt, CW, 6-Groove Pulley

Used On: (2002-01) Chevrolet Suburban 5.3L, 6.0L, 8.1L

(2002-01) Chevrolet Tahoe 5.3L

(2002-01) GMC Yukon 5.3L, 6.0L

(2002-01) GMC Yukon XL 5.3L, 6.0L, 8.1L

Replaces: Bosch 6-004-ML0-024, Delco 15755900

Lester Nos: 13860

Features: 100% New



1-2547-00B0

(Ref# 12490N)

Alternator - Bosch IR/IF

160A/12 Volt, CW, 1-Wire System

Used On: Trucks & Industrial Equipment w/ J180 Mount

Alternators

(cont'd)

(cont'd)

Replaces: Bosch 0-124-525-085, AL9960LH

Lester Nos: 12490

Dim: M8 x 1.25 Batt. Term. (replaces 5/16")

M6 x 1.0 Batt. Term. (replaces 1/4")

M5-0.8 I-Term.

Univ. R-Term.

Note: Bosch style replacement for Delco 21SI, 22SI Series, Leece-Neville JB Series, Motorola Load Handler Alternators

Features: 100% New, dual internal cooling fans
Over 220-medium & heavy duty applications spanning 4-8 truck classes



1-2589-01B0

Alternator - Bosch IR/IF

150 Amp/12 Volt, CW, 6-Groove Clutch Pulley

Used On: (2006-04) Dodge Sprinter Van 2.7L (Diesel)

(2003-00) Freightliner Sprinter Van 2.7L (Diesel)

Replaces: Bosch 0-124-615-019, 0-124-615-033;

Chrysler 5103887AA; 5134205AA, AB;

Mercedes 012-154-15-02, 012-154-46-02, 013-154-13-02

Lester Nos: 12384

Features: 100% New



1-2685-00B0

Alternator - Bosch IR/IF

150 Amp/12 Volt, CW

Used On: Freightliner w/ Detroit Diesel Series 60

Replaces: Bosch 0-124-525-109, AL9961LH

Lester Nos: 12491

Note: Also replaces Delco 22SI alternators: 19020388, 389, 889 (WAI 1-2428-00DR, Lester 8361, 8362)

Features: 100% New



1-2768-01B0

(Ref# 12382N)

Alternator - Bosch IR/IF

90 Amp/12 Volt, CW, 6-Groove Clutch Pulley

Used On: (2006-00) Dodge Sprinter, Freightliner Sprinter Vans 2.7L Diesel

Replaces: Bosch 0-124-325-039, 0-124-325-046;

Chrysler 5134199AA; Mercedes 012-154-20-02, 012-154-22-02

Lester Nos: 12382

Features: 100% New



1-2852-01B0

Alternator - Bosch IR/IF

200 Amp/12 Volt, CW, 6-Groove Clutch Pulley

Used On: (2006-05) Dodge Sprinter Van 2.7L (Diesel)

Replaces: Bosch 0-124-625-020;

Chrysler 5117587AA, 5117587AB; Mercedes 013-154-11-02

Lester Nos: 12385

Features: 100% New



1-2878-01B0

Alternator - Bosch IR/IF

125 Amp/12 Volt, CW, 6-Groove Pulley

Used On: (2007) Chevrolet Silverado, GMC Sierra 6.0L, 6.6L

Replaces: Bosch 0-124-425-035, GM 15204278

Lester Nos: 11234

HEAVY DUTY & OFF ROAD

HEAVY DUTY & OFF ROAD

BOSCH - STARTERS

DD (Direct Drive)



2-1803-B0-2

(Ref# 17095N)

Starter - Bosch DD

3.0kW/12 Volt, CW, 10-Tooth Pinion

Used On: John Deere

Replaces: Bosch 0-001-362-312, -316; 0-001-367-075, -078; 0-001-369-001, -005, 0-022; John Deere AL39700, AL41247, AL62690, AL62772

Lester Nos: 17095

Features: 100% New



2-2283-B0

Starter - Bosch DD

24 Volt, CW, 9-Tooth Pinion

Used On: Fiat-Allis Crawler Loader, Excavator, Grader w/ 8041, 8051, 8061, 8065 Diesel Engines

Replaces: Bosch 0-001-360-015, -043; 0-001-368-019; Marelli MT67AA, AB, AC, AD, DA, DB

Lester Nos: 18030, 18090, 18092

Features: 100% New



2-2284-B0

Starter - Bosch DD

24 Volt, CW, 9-Tooth Pinion

Used On: Fiat-Allis Excavators

Replaces: Bosch 0-001-360-027, 0-001-368-021; Marelli 63216733, MT67BA

Lester Nos: 18032

Features: 100% New



2-2285-B0

Starter - Bosch DD

24 Volt, CW, 10-Tooth Pinion

Used On: Volvo Excavators, Loaders w/ TD40GDE, TD40GFE Engines

Replaces: Caterpillar 109-2361, Bosch 0-001-368-085, Iveco 154011053; Perkins 2873D304, 3872D304

Lester Nos: 18251

Features: 100% New



2-2297-B0

Starter - Bosch DD

24 Volt, CW, 9-Tooth Pinion

Used On: Mercedes Trucks, Unimog, Otomarsan Trucks

Replaces: Bosch 0-001-360-011, -022, -037; 0-001-363-307; 0-001-368-024, -048, -055, -062, -300, -307, -309

Lester Nos: 18371

Features: 100% New



2-2298-B0

Starter - Bosch DD

12 Volt, CW, 10-Tooth Pinion

Used On: Perkins Engines

Replaces: Bosch 0-001-367-069

Lester Nos: 18387

Features: 100% New



2-2299-B0
Starter - Bosch DD
24 Volt, CW, 10-Tooth Pinion

Used On: DAF, Hanomag, Massey Ferguson, Perkins
Replaces: Bosch 0-001-368-040, -051;
 Massey Ferguson 3091293-M92
Lester Nos: 18254
Features: 100% New



2-2325-B0
Starter - Bosch DD
12 Volt, CW, 9-Tooth Pinion

Used On: Allis-Chalmers Tractors, Fiat-Allis
Replaces: Bosch 0-001-362-032, -039, -332;
 Marelli 63217101, 63217125, 63217126, MT71AA, AB
Lester Nos: 17093, 17126
Features: 100% New



2-2669-B0
 (Ref# 17309N)
Starter - Bosch DD
3.0kW/12 Volt, CW, 10-Tooth Pinion

Used On: Mercedes L1113, L1116, L1117, L1117, L1316,
 L1317, L1319, L1419, L1516, LA1113, LA1117, LP1219 Trucks
 w/ OM352, OM366 Diesel Engines
Replaces: Bosch 9-000-083-071; Mercedes 344-151-05-01
Lester Nos: 17309
Features: 100% New



photo not available

2-2680-B0
Starter - Bosch DD
4.0kw/24 Volt, CW, 10-Tooth Pinion

Used On: Renault Trucks (Europe)
Replaces: Bosch 0-001-368-306; Renault 0025841044,
 5000791211, 5001014221, 5010090370, 5010090683



2-2707-B0-2
 (Ref# 17077N)
Starter - Bosch DD
3.0kW/12 Volt, CW, 10-Tooth Pinion

Used On: Case, International Tractors
Replaces: Bosch 0-001-362-310, 0-001-362-527,
 0-001-367-042; IHC 10965R93, 529965R92, 529965R93
Lester Nos: 17077
Features: 100% New



50-9100-1
 (Ref# 17106N)
Starter - Bosch DD
12 Volt, CW, 9-Tooth Pinion

Used On: Claas, New Holland Combines; Mercedes-Benz Truck
 w/ OM352 Engine
Replaces: Bosch 0-001-359-043, -084; 0-001-367-034, -059,
 -300, -301; 9-000-083-028, -054
Lester Nos: 17106
Note: Bosch JF design (0-001-367-034)
Features: 100% New

HEAVY DUTY & OFF ROAD

HEAVY DUTY & OFF ROAD

BOSCH - STARTERS

DD (Direct Drive) (cont'd)

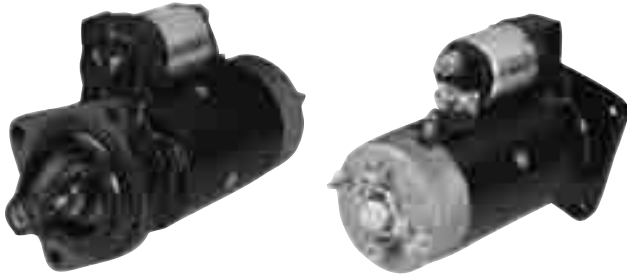

50-9101-1

(Ref# 18029N)

Starter - Bosch DD

12 Volt, CW, 9-Tooth Pinion

Used On: Fiatallis Industrial Equipment, Iveco Trucks

Replaces: Bosch 0-001-359-021, -102; 0-001-367-028; Marelli MT68AA, AB, AC, AD

Lester Nos: 18029

Note: Bosch JF design (0-001-367-028)

Features: 100% New



50-9102

Starter - Bosch DD

12 Volt, CW, 9-Tooth Pinion

Used On: Mack-Scania, Saab-Scania

Replaces: Bosch 0-001-359-022, -032, -101; 0-001-367-033

Lester Nos: 16559

Note: Also replaces Delco 1113474 (Lester 3755)

Features: 100% New



50-9105-1

Starter - Bosch DD

12 Volt, CW, 9-Tooth Pinion

Used On: Iveco, Magirus

Replaces: Bosch 0-001-359-122, 0-001-367-029; Marelli MT68LA, LB, LC

Lester Nos: 17092

Note: Bosch JF design (0-001-367-029)

Features: 100% New



50-9107

Starter - Bosch DD

12 Volt, CW, 9-Tooth Pinion

Used On: Atlas, New Holland w/ Deutz Engine

Replaces: Bosch 0-001-358-047, 0-001-362-046

Lester Nos: 17112

Note: Also replaces Bosch 0-001-358-047

Features: 100% New



50-9108

Starter - Bosch DD

24 Volt, CW, 9-Tooth Pinion

Used On: Fiat-Allis Excavators, Wheel Loaders w/ 8041, 8045 Diesel Engines

Replaces: Bosch 0-001-363-101, -111; Fiat 4691200, 4706931, 4744841; Iveco 4744811

Lester Nos: 18031

Features: 100% New



50-9109-1

(Ref# 17074N)

Starter - Bosch DD

12 Volt, CW, 9-Tooth Pinion

Used On: Atlas Copco, Claas, Deutz, Deutz-Allis, Fuchs, International, Iveco Trucks, KHD, Liebherr, New Holland

Replaces: Bosch 0-001-359-027, -073; 0-001-367-004

Lester Nos: 17074

Note: Bosch JF design (0-001-367-004)

Features: 100% New



50-9110-1

(Ref# 17073N)

Starter - Bosch DD

24 Volt, CW, 9-Tooth Pinion

Used On: Fuchs Excavator, Iveco Trucks w/ Deutz BF6L913 Engine

Replaces: Bosch 0-001-360-012, -035; 0-001-368-001

Lester Nos: 17073

Features: 100% New



50-9115

Starter - Bosch DD

24 Volt, CW, 11-Tooth Pinion

Used On: Atlas Excavator, Atlas Copco, Fiat-Allis, KHD F6-L413, F8-L413 Diesel Engines

Replaces: Bosch 0-001-410-046, 0-001-410-063

Lester Nos: 17094

Note: By rotating D.E. housing, 50-9115 will also replace Bosch starters: 0-001-410-044, -045, -046, -053, -062, -099; 0-001-411-016, -036; 0-001-414-008, -019; 0-001-415-011, -013; 0-001-416-003, -005, -009, -030; 0-001-417-025

Features: 100% New



50-9117

Starter - Bosch DD

24 Volt, CW, 9-Tooth Pinion

Used On: MAN, Mercedes Trucks

Replaces: Bosch 0-001-411-009, 0-001-415-001, 0-001-416-002, 0-001-417-001

Lester Nos: 18113, 18375

Note: Also replaces Bosch 0-001-410-088*, 0-001-411-009*, 0-001-411-022**, 0-001-416-002, 0-001-416-010**, 0-001-417-001*, 0-001-417-037**

*50-9117 has approximately 1KW lower torque than OE.

**OE is isolated ground. 50-9117 is case ground.

Features: 100% New



50-9122-1

Starter - Bosch DD

24 Volt, CW, 9-Tooth Pinion

Used On: Fiat-Allis Crawler, Wheel Loaders w/ 8361 Diesel Engine

Replaces: Bosch 0-001-360-063, 0-001-368-020; Marelli 63216740, 63216741, MT67CA, MT67CB

Lester Nos: 18033

Features: 100% New



50-9124-1

(Ref# 17075N)

Starter - Bosch DD

12 Volt, CW, 9-Tooth Pinion

Used On: Atlas, Atlas Copco, Claas, Deutz Tractor, Deutz-Fahr, International, Iveco Trucks, KHD, Liebherr

Replaces: Bosch 0-001-358-046, -049; 0-001-362-016, -034, -091, -305, -311, -313

Lester Nos: 17075

Features: 100% New

PLGR (Planetary Gear Reduction)



2-1946-B0

(Ref# 18230N)

Starter - Bosch PLGR

2.2kW/12 Volt, CW, 11-Tooth Pinion

Used On: KHD F2L1011, F3L1011, F4L1011, BF4L1011 Diesel Engines; Vermeer 3550 Trencher w/ KHD-Deutz Diesel

Replaces: Bosch 0-001-218-172, 0-001-223-002; KHD 118-0180, 118-0995

Lester Nos: 18230

Features: 100% New

HEAVY DUTY & OFF ROAD

HEAVY DUTY & OFF ROAD

BOSCH - STARTERS

PLGR (Planetary Gear Reduction) (cont'd)



2-2355-BO-1
(Ref# 18360N)

Starter - Bosch PLGR
12 Volt, CW, 10-Tooth Pinion

Used On: (2006-04) Dodge Sprinter Van 2.7L (Diesel)
(2003-00) Freightliner Sprinter Van 2.7L (Diesel)
(2006-05) Mercedes E Class 3.2L (Diesel)
Replaces: Bosch 0-001-109-250, 0-001-223-005;
Chrysler 5073919AA; 5103581AA, AB; 5117537AA, AB;
5134510AA, AB; Mercedes 005-151-13-01, 005-151-29-01,
005-151-66-01; Valeo D7R43, D7R46
Lester Nos: 18360
Note: 2-2355-BO & 2-2355-BO-1 are similar except:
2-2355-BO PMGR design
2-2355-BO-1 PLGR design
Features: 100% New



2-2463-BO

Starter - Bosch PLGR
2.2kW/12 Volt, CW, 9-Tooth Pinion

Used On: Iveco
Replaces: Bosch 0-001-218-174; Iveco 42498678, 99451753
Features: 100% New



photo not available

2-2736-BO-2
(Ref# 18232N)

Starter - Bosch PLGR
3.0kW/12 Volt, CW, 9-Tooth Pinion

Used On: KHD, SAME Tractors
Replaces: Bosch 0-001-230-006, KHD 1180928
Lester Nos: 18232
Features: 100% New

PMGR (Perm. Magnet Gear Reduction)



2-2355-BO

Starter - Bosch PMGR
12 Volt, CW, 10-Tooth Pinion

Used On: (2006-04) Dodge Sprinter Van 2.7L (Diesel)
(2003-00) Freightliner Sprinter Van 2.7L (Diesel)
(2006-05) Mercedes E Class 3.2L (Diesel)
Replaces: Bosch 0-001-109-250, 0-001-223-005;
Chrysler 5073919AA; 5103581AA, AB; 5117537AA, AB;
5134510AA, AB; Mercedes 005-151-13-01, 005-151-29-01,
005-151-66-01; Valeo D7R43, D7R46
Lester Nos: 18360
Note: 2-2355-BO & 2-2355-BO-1 are similar except:
2-2355-BO PMGR design
2-2355-BO-1 PLGR design
Features: 100% New



2-2362-BO

(Ref# 18369N)

Starter - Bosch PMGR
1.8kW/12 Volt, CCW, 9-Tooth Pinion

Used On: Ruggnerini, Lombardini, Hatz
Replaces: Bosch 0-001-109-029, Hatz 50316401,
Lombardini 58400890
Lester Nos: 18369
Features: 100% New



2-2553-BO

Starter - Bosch PMGR
2.0kW/12 Volt, CW, 9-Tooth Pinion

Used On: Perkins Engines
Replaces: Bosch 0-001-109-035; Perkins 18508660;
Yale 19960488, 19960489, 50027532
Lester Nos: 18949
Features: 100% New



2-2690-B0
Starter - Bosch PMGR
1.1kW/12 Volt, CW, 9-Tooth Pinion

Used On: Perkins Engines
Replaces: Bosch 0-001-107-078; Perkins 18508661
Lester Nos: 18948
Features: 100% New

DELCO - ALTERNATORS

7SI Series



1-2488-01DR
 (Ref# 92614N)

Alternator - Delco 7SI Series
70 Amp/12 Volt, CW, 2-Groove Pulley

Used On: Hyster Lift Trucks
Replaces: Delco 19020614
Features: 100% New



1-2489-01DR
 (Ref# 92615N)

Alternator - Delco 7SI Series
70 Amp/12 Volt

Used On: Hyster Lift Trucks
Replaces: Delco 19020615
Features: 100% New

10DN Series



20-101-1
 (Ref# 7122N)

Alternator - Delco 10DN Series
63 Amp/12 Volt, CW, 1-Groove Pulley

Used On: (1971-68) AMC, Buick, Cadillac, Chevrolet, Oldsmobile, Pontiac
 Allis-Chalmers, Austin Western, Baker, Case, Chevrolet/GMC Truck, International, Massey Ferguson
Replaces: Delco 1100849, 1100883
Lester Nos: 7122
Features: 100% New

10SI Series

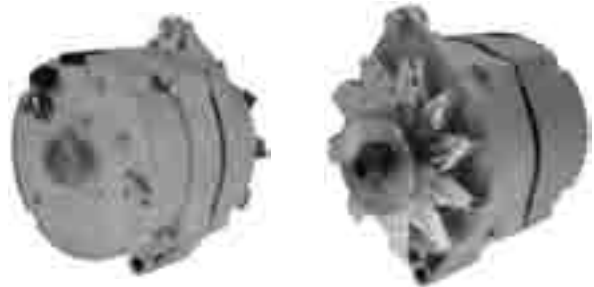

1-2410-11DR-1

Alternator - Delco 10SI/102 Series
22 Amp/12 Volt, 1-Groove Pulley, 1-Wire System

Used On: Farm & Industrial Equipment requiring enclosed alternator for adverse environments
Replaces: Caterpillar 351940; Delco 1100092, 1100499, 1102871, 1103134, 1103190, 1105063, 1105076
Lester Nos: 7164
Features: 100% New, self exciting, 1-wire hookup
 Totally enclosed design for adverse environments

1-2410-11DR

Alternator - Delco 10SI/102 Series
Note: Same as 1-2410-11DR-1 except remanufactured

HEAVY DUTY & OFF ROAD

HEAVY DUTY & OFF ROAD

DELCO - ALTERNATORS

10SI Series (cont'd)

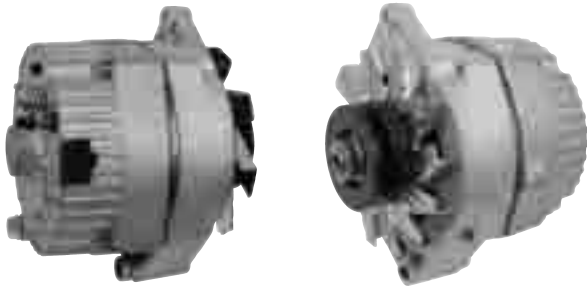

1-2720-11DR-2
(Ref# 102916N)

Alternator - Delco 10SI Series
40 Amp/24 Volt, 1-Wire System

Used On: Industrial Equipment

Replaces: Delco 1102916, John Deere TY6752

Features: 100% New, self exciting, 1-wire hookup



20-102-1
(Ref# 7127NSE)

Alternator - Delco 10SI Series
63 Amp/12 Volt, CW, 1-Groove Pulley, 1-Wire System

Used On: Farm & Industrial Applications

Features: 100% New, self exciting, very low cut-in
Standard & metric mounting

20-102-5
(Ref# 7127NSE-SP)

Alternator - Delco 10SI Series

Note: Same as 20-102-1 except w/ 6-Groove Pulley (24-1255-3)



20-104-1
(Ref# 7186N)

Alternator - Delco 10SI/116 Series
72 Amp/12 Volt, 1-Groove Pulley

Used On: Farm & Industrial Applications

Replaces: Delco 1105423

Lester Nos: 7154, 7186

Note: 17mm (.669") rotor shaft, standard & metric mtg.

Features: 100% New

12SI Series



20-110-2

Alternator - Delco 12SI Series

94 Amp/12 Volt, CW, 1-Groove Pulley, 1-Wire System

Used On: Farm & Industrial Applications requiring low cut-in & 1-wire hook-up

Dim: M8 x 1.25 Adj. Ear

Note: Self-exciting, 1-wire version of 20-110-1 (Lester 7294)

Features: 100% New, self exciting, 1-wire hookup
Very low cut-in

15SI Series

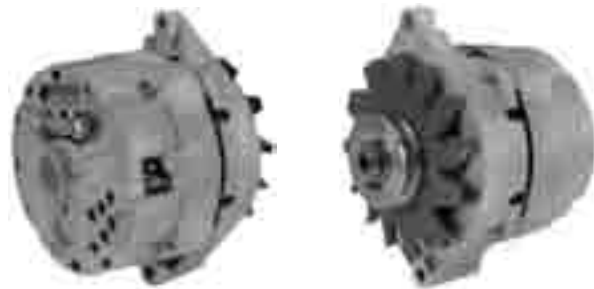

20-113-1
(Ref# 7853N)

Alternator - Delco 15SI Series

105 Amp/12 Volt, CW, 1-Groove Pulley

Used On: Allis-Chalmers, Case, Cummins, Deutz-Allis,
International, Steiger, Versatile, White

Replaces: Cummins 3909982; Delco 1101439, 1101440,
1105418, 1105535, 1105536, 1105538, 1105539, 1105540,
1105560, 1105605, 1105609

Lester Nos: 7853

Features: 100% New

17SI Series



20-116-1

Alternator - Delco 17SI Series

120 Amp/12 Volt, CW, 1-Groove Pulley

(cont'd)

(cont'd)

Used On: (1990-86) Chevrolet, GMC P Series Step Van 6.2L (Diesel)

Replaces: Delco 1101215, 1105658, 1105690

Lester Nos: 7287

Features: 100% New

19SI Series



1-2427-30DR

(Ref# 8098N)

Alternator - Delco 19SI Series

105 Amp/12 Volt, CW, 3-Wire System

Used On: Cummins Engines

Replaces: Cummins 3675254RX, 3934777; Delco 19009950, 19009951, 19009952, 19009956

Lester Nos: 8098

Dim: M6 Batt. Term.

M4 R-terminal

Features: 100% New

20SI Series



20-117-1

(Ref# 7266N)

Alternator - Delco 20SI Series

60 Amp/12 Volt, Neg. Grd., wo/ pulley

Used On: (1993-90) Chevrolet Kodiak, GMC Topkick Truck 6.6L

Replaces: Caterpillar 2S7029, 7G7889; Delco 1117611, 613, 618, 641; IHC 586986C91

Lester Nos: 7266

Features: 100% New



20-118-1

(Ref# 7297N)

Alternator - Delco 20SI Series

45 Amp/24 Volt, Neg. Grd., wo/ pulley

Used On: Allis-Chalmers, Case, Caterpillar, Cummins Engine, Dresser, Fiat-Allis, International, Wabco

Replaces: Caterpillar 5N5692; Delco 1117615, 1117640, 1117642, 1117643, 1117644, 1117645, 1117647, 1117655

Lester Nos: 7297, 7467

Features: 100% New

21SI Series

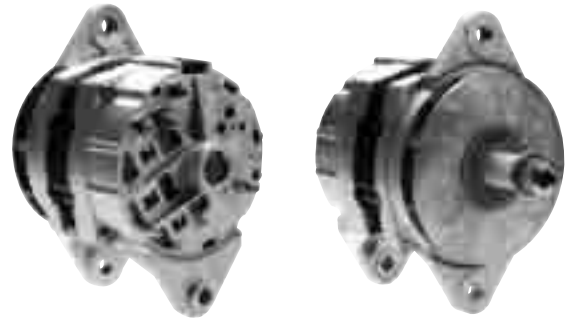

1-1915-00DR

Alternator - Delco 21SI Series

115 Amp/12 Volt, 1-Wire System, Neg. Grd.

Used On: Cummins, Detroit Diesel, Ford Truck, International-Navistar, Mack, Volvo White-GMC

Replaces: Delco 1117880, 894, 906, 925, 931, 942, 947, 950, 951, 953, 954, 955, 956; 19010155

Lester Nos: 7667, 7670, 7671, 7976, 8011, 8012, 8013

Dim: 1/4-28 Batt. Term.

Universal R-Term.

10-24 I-Term.

Note: Bidirectional Fan wo/ pulley

Features: 100% New

HEAVY DUTY & OFF ROAD

HEAVY DUTY & OFF ROAD

DELCO - ALTERNATORS

21SI Series (cont'd)

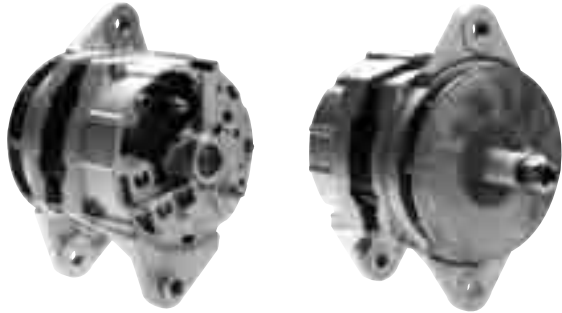

1-1916-00DR

Alternator - Delco 21SI Series

100 Amp/12 Volt, 3-Wire System, Neg. Grd.

Used On: Chevrolet Kodiak, GMC Topkick 6.6L, 8.2L

Replaces: Delco 1117895, 1117903, 1117927

Lester Nos: 7666

Dim: 5/16-18 Batt. Term.
10-24 R-Term.

Note: 10-24 R-terminal located in I-term. hole, Bidirectional Fan wo/ pulley

Features: 100% New

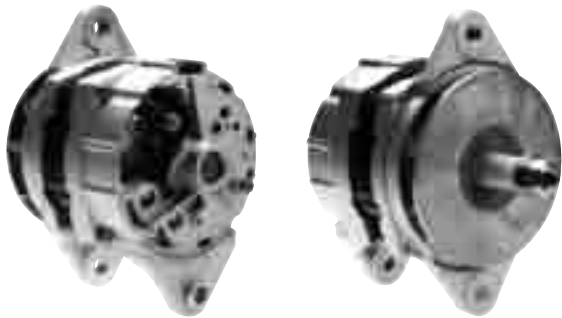

1-1917-00DR

Alternator - Delco 21SI Series

130 Amp/12 Volt, 3-Wire System, Neg. Grd.

Used On: Chevrolet Truck B6, B7 Series, Kodiak; GMC Topkick 6.6L, 8.2L

Replaces: Delco 1117896, 1117904, 1117928

Lester Nos: 7971

Dim: 5/16-18 Batt. Term.
10-24 R-Term.

Note: 10-24 R-terminal located in I-term. hole, Bidirectional Fan wo/ pulley

Features: 100% New

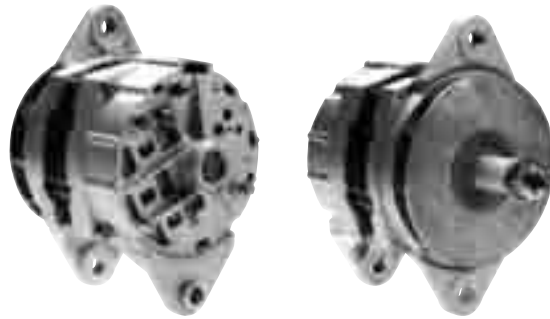

1-1918-00DR

Alternator - Delco 21SI Series

130 Amp/12 Volt, 1-Wire System, Neg. Grd.

Used On: Ford Truck, International-Navistar

Replaces: Delco 1117911, 914, 929, 932, 946, 949, 957, 958, 959, 962

Lester Nos: 7564, 7565, 7654, 7659, 8026, 8027

Dim: 1/4-28 Batt. Term.

Universal R-Term.

10-24 I-Term.

Note: Bidirectional Fan wo/ pulley

Features: 100% New

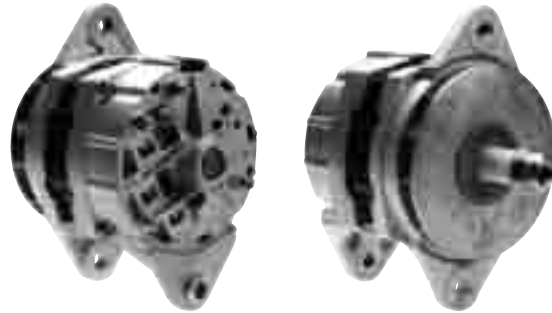

1-2291-00DR

Alternator - Delco 21SI Series

70 Amp/24 Volt, 1-Wire System, Neg. Grd.

Used On: Cummins, Timberjack w/ Cummins 5.9L, 8.3L Diesel

Replaces: Delco 1117897, 1117900, 19010111, 19010182

Lester Nos: 7642, 8003

Dim: M6 x 1.0 Batt. Term.

Universal R-Term.

M4 I-Term.

Note: Bidirectional Fan wo/ pulley

Features: 100% New

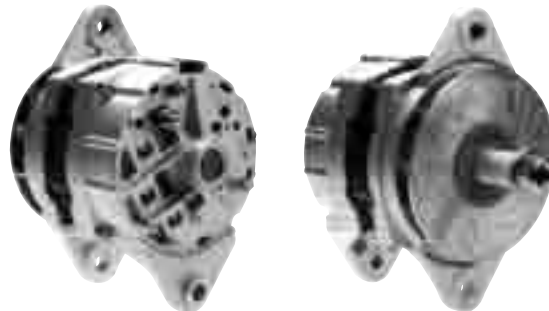

1-2292-00DR

Alternator - Delco 21SI Series

70 Amp/24 Volt, 1-Wire System, Neg. Grd.

Used On: Fiatallis Equipment

Replaces: Delco 1117915

(cont'd)

(cont'd)

Lester Nos: 8030
Dim: 5/16-18 Batt. Term.
 10-24 I-Term.
Note: Bidirectional Fan wo/ pulley
Features: 100% New

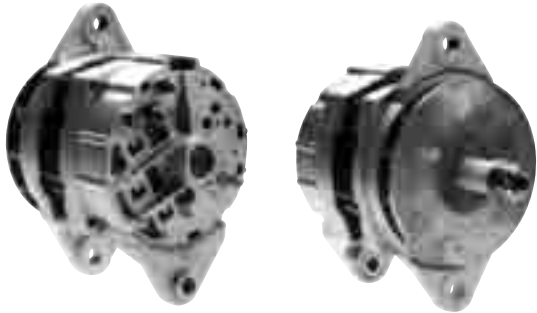

1-2297-00DR

Alternator - Delco 21SI Series

100 Amp/12 Volt, 1-Wire System, Neg. Grd.

Used On: Freightliner, Kenworth, Volvo Trucks, Western Star
Replaces: Delco 19010101, 19010105, 19010181
Lester Nos: 7662
Dim: 5/16-18 Batt. Term.
 Universal R-Term.
 10-24 I-Term.
Note: Bidirectional Fan wo/ pulley
Features: 100% New

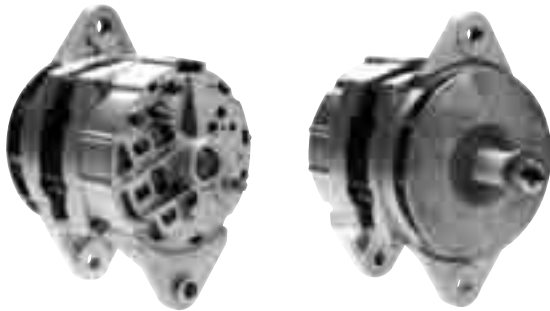

1-2299-00DR

Alternator - Delco 21SI Series

145-160 Amp/12 Volt, 1-Wire System, Neg. Grd.

Used On: Ford Truck, International-Navistar
Replaces: Delco 1117916, 1117924, 1117933, 1117948, 1117952, 19010156
Lester Nos: 7644, 7669, 7672
Dim: 1/4-28 Batt. Term.
 Universal R-Term.
 10-24 I-Term.
Note: Bidirectional Fan wo/ pulley
Features: 100% New

21SI, 22SI FEATURES

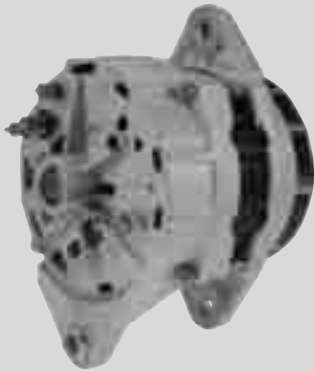

- 100% New
- WAI-Transpo premium rectifier & regulator
- Premium, hi-temperature WBD 6305 bearing
- Long-shaft rotor & longer needle bearing provides more bearing surface to spread the load for longer lasting service
- 1/4-20 thru bolts used on 21SI - larger than OE 10-24 bolts
- Rotor coil leads are epoxied to prevent vibration failure
- Hi-temperature class-H windings
- Precision CNC machined castings
- OE performance output curve
- Universal R-terminal - designed by WAI, features both pin type & 10-24 threaded connection

| Volt | System | Amp | Batt. Term. | R-Term. | I-Term. | WAI | Note |
|--------------------------------|--------|----------|-------------|-----------|-------------|---------------|---------------|
| 21SI SERIES ALTERNATORS | | | | | | | |
| 12V | 1-Wire | 100A | 5/16" | Universal | 10-24 | 1-2297-00DR | |
| | | 115A | 1/4" | Universal | 10-24 | 1-1915-00DR | |
| | | | 5/16" | Universal | 10-24 | 1-2333-00DR | |
| | | 130A | 1/4" | Universal | 10-24 | 1-1918-00DR | |
| | | | 5/16" | Universal | 10-24 | 1-2300-00DR | |
| | | 145-160A | 1/4" | Universal | 10-24 | 1-2299-00DR | |
| | 5/16" | | Universal | 10-24 | 1-2334-00DR | 14.0Vset | |
| | | | | | | | 1-2334-00DR-3 |
| 24V | 1-Wire | 100A | 5/16" | 10-24* | - | 1-1916-00DR | |
| | | 130A | 5/16" | 10-24* | - | 1-1917-00DR | |
| | | 70A | M6 | Universal | M4 | 1-2291-00DR | |
| | | | 5/16" | - | 10-24 | 1-2292-00DR | |
| 22SI SERIES ALTERNATORS | | | | | | | |
| 12V | 1-Wire | 100A | 1/4" | Universal | 10-24 | 1-2154-00DR | |
| | | | 5/16" | Universal | 10-24 | 1-2044-00DR | |
| | | 130A | 1/4" | Universal | 10-24 | 1-2431-00DR-3 | |
| | | 145-160A | 1/4" | Universal | 10-24 | 1-2280-00DR | |
| | | | 5/16" | Universal | 10-24 | 1-2065-00DR | 14.0Vset |
| | | | | 10-24 | 10-24 | 1-2065-00DR-3 | 14.6Vset |
| | | | | | 10-24 | 10-24 | 1-2428-00DR-3 |

HEAVY DUTY & OFF ROAD

HEAVY DUTY & OFF ROAD

DELCO - ALTERNATORS

21SI Series (cont'd)

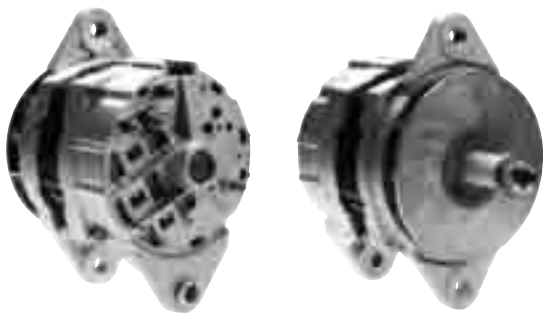

1-2300-00DR

Alternator - Delco 21SI Series

130 Amp/12 Volt, 1-Wire System, Neg. Grd.

Used On: AGCO AG, Caterpillar Tractor, Ford AG, Freightliner, John Deere, Kenworth, Mack, New Holland, Peterbilt, Volvo Truck, Western Star

Replaces: Delco 1117905, 1117909, 1117937, 1117943, 1117965, 1117966, 19010147, 19010196

Lester Nos: 7673, 7680, 7681

Dim: 5/16-18 Batt. Term.

Universal R-Term.

10-24 I-Term.

Note: Bidirectional Fan wo/ pulley

Features: 100% New

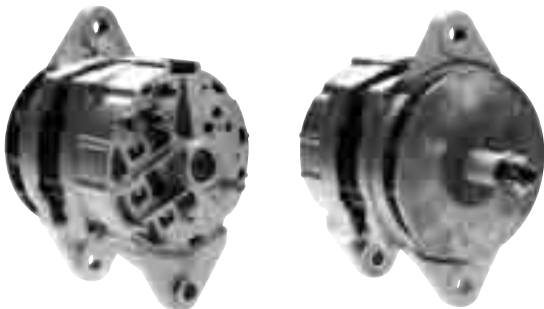

1-2333-00DR

Alternator - Delco 21SI Series

115 Amp/12 Volt, 1-Wire System, Neg. Grd.

Used On: Freightliner, Kenworth, Mack, Peterbilt, Volvo Truck, Western Star

Replaces: Delco 1117885, 1117886, 1117887, 1117890, 1117892, 1117910, 1117923, 1117941

Lester Nos: 7641, 7660, 7662, 7663, 7664, 7668, 7683

Dim: 5/16-18 Batt. Term.

Universal R-Term.

10-24 I-Term.

Note: Universal R-terminal, 10-24 I-terminal, Bidirectional Fan wo/ pulley

Features: 100% New

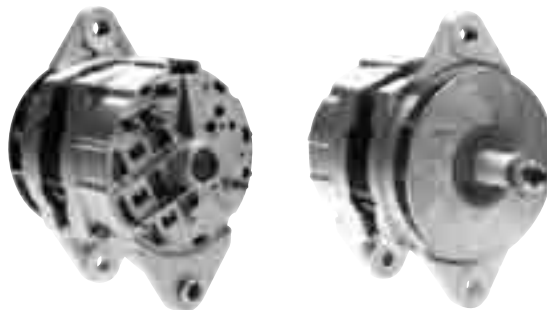

1-2334-00DR

Alternator - Delco 21SI Series

145-160A/12V, 1-Wire System, 14.0 Vset, Neg. Grd.

Used On: Freightliner, Kenworth, Mack, Peterbilt, Volvo Truck

Replaces: Delco 1117917, 1117919, 1117920, 1117921, 1117922, 1117934, 1117964, 19010202

Lester Nos: 7679, 7685, 7686, 8020, 8021, 8022, 8023

Dim: 5/16-18 Batt. Term.

Universal R-Term.

10-24 I-Term.

Note: Bidirectional Fan wo/ pulley

Features: 100% New

1-2334-00DR-3

Alternator - Delco 21SI Series

Note: Same as 1-2334-00DR except 14.6 Vset

22SI Series

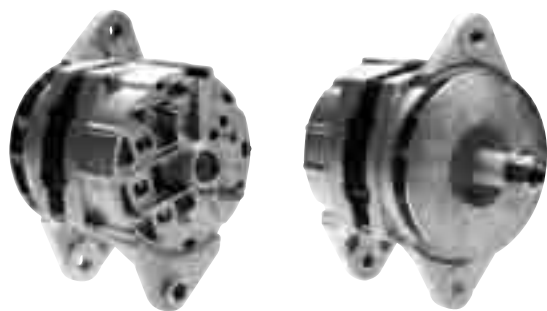

1-2044-00DR

Alternator - Delco 22SI Series

100 Amp/12 Volt, 1-Wire System, Neg. Grd.

Used On: Ford Truck, Freightliner, Volvo Truck, Western Star

Replaces: Delco 19020300

Lester Nos: 8071

Dim: 5/16-18 Batt. Term.

Universal R-Term.

10-24 I-Term.

Note: Bidirectional Fan wo/ pulley

Features: 100% New



1-2065-00DR

Alternator - Delco 22SI Series

145A/12V, 1-Wire System, 14.0 Vset, Neg. Grd.

Used On: Freightliner, Kenworth, Peterbilt, Volvo Truck

Replaces: Delco 19020302, 19020303

Lester Nos: 8072, 8078

Dim: 5/16-18 Batt. Term.

Universal R-Term.

10-24 I-Term.

Note: Bidirectional Fan wo/ pulley

Also replaces Delco 21SI 1117905, 1117943.

Features: 100% New

1-2065-00DR-3

Alternator - Delco 22SI Series

Note: Same as 1-2065-00DR except 14.6 Vset

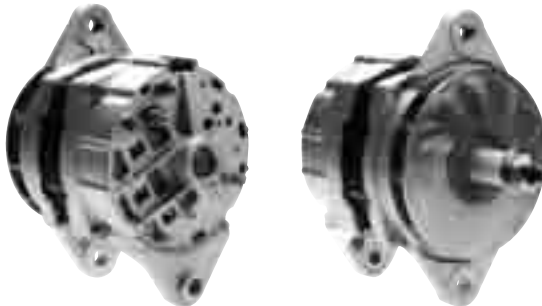

1-2154-00DR

Alternator - Delco 22SI Series

100 Amp/12 Volt, 1-Wire System, Neg. Grd.

Used On: International-Navistar

Replaces: Delco 19020305, 19020308, 19020312, 19020379

Lester Nos: 8070, 8074

Dim: 1/4-28 Batt. Term.

Universal R-Term.

10-24 I-Term.

Note: Bidirectional Fan wo/ pulley

Also replaces Delco 21SI 1117880, 1117894, 1117925, 1117931, 1117942, 1117951, 1117953, 1117954, 1117955, 1117956.

Features: 100% New

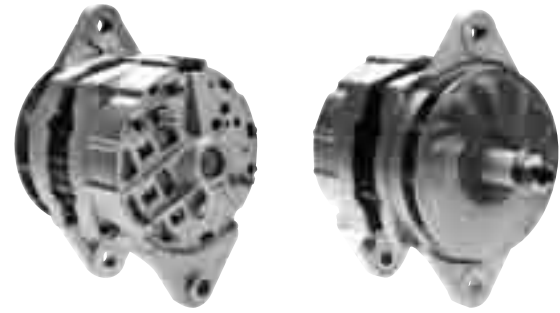

1-2280-00DR

Alternator - Delco 22SI Series

145 Amp/12 Volt, 1-Wire System, Neg. Grd.

Used On: International-Navistar

Replaces: Delco 19020306, 19020310

Lester Nos: 8076, 8079

Dim: 1/4-28 Batt. Term.

Universal R-Term., 10-24 I-Term.

Note: Bidirectional Fan wo/ pulley

Features: 100% New



1-2428-00DR-3

Alternator - Delco 22SI Series

145 Amp/12 Volt, 1-Wire System, Neg. Grd.

Used On: Freightliner w/ Detroit Diesel Series 60

Replaces: Delco 19020388, 19020389, 19020889

Lester Nos: 8361, 8362

Dim: 5/16-18 Batt. Term.

10-24 R-Term., 10-24 I-Term.

Note: Bidirectional Fan wo/ pulley

Features: 100% New



1-2431-00DR-3

Alternator - Delco 22SI Series

130 Amp/12 Volt, 1-Wire System, Neg. Grd.

Used On: Freightliner, Mack, Peterbilt Trucks

Replaces: Delco 19020309

Lester Nos: 8073

Dim: 1/4-28 Batt. Term.

Universal R-Term., 10-24 I-Term.

Note: Bidirectional Fan wo/ pulley

Features: 100% New

HEAVY DUTY & OFF ROAD

HEAVY DUTY & OFF ROAD

DELCO - ALTERNATORS

22SI Series Oval Plug



1-2662-00DR
(Ref# 59481N)

**Alternator - Delco 22SI Series Oval Plug
100 Amp/12 Volt**

Replaces: Delco 8600112, 10459481, 19020385, 19020810, 19116396

Lester Nos: 8363

Dim: M10 x 1.5 Batt. Term.

Note: Bidirectional Fan wo/ pulley

Features: 100% New



1-2663-00DR

**Alternator - Delco 22SI Series Oval Plug
130 Amp/12 Volt**

Replaces: Delco 10459483, 19020384, 19020812

Lester Nos: 8364

Note: Bidirectional Fan wo/ pulley

Features: 100% New

23SI Series



1-2571-00DR

**Alternator - Delco 23SI Series
70 Amp/24 Volt**

Replaces: Cummins 3675250RX, 3675252RX;
Delco 19011004, 19011015, 19011019

Dim: 5/16-18 Batt. Term.

(cont'd)

(cont'd)

10-24 I-Term.

10-24 R-Term.

Features: 100% New

24SI Series



1-2570-00DR

**Alternator - Delco 24SI Series
145 Amp/12 Volt**

Replaces: Delco 8700008, 19020900

Dim: 5/16-18 Batt. Term.

Features: 100% New

25SI Series



20-119-1

(Ref# 7255N)

**Alternator - Delco 25SI Series
75 Amp/12 Volt, Neg. Grd., wo/ pulley**

Replaces: Caterpillar 0R5205, 5S6698; Cummins 200305, 203177, 3603850RX; Delco 1117225, 1117231, 1117234, 1117241, 1117244, 1117251

Lester Nos: 7255

Features: 100% New



20-121-1

(Ref# 7254N)

**Alternator - Delco 25SI Series
50 Amp/24 Volt, Neg. Grd., wo/ pulley**

Used On: Allis-Chalmers, Case, Caterpillar, Clark, Cummins

(cont'd)

(cont'd)

Engine, Dresser, Euclid, Fiat-Allis, Murphy Diesel, Terex, Volvo Truck, Waukesha, Western Star, White Truck

Replaces: Caterpillar 9G9538, Cummins 3603848RX; Delco 1117226, 1117236, 1117239, 1117248, 1117250, 1117253, 1117258, 10459006

Lester Nos: 7254

Features: 100% New



20-178-1

(Ref# 7252N)

Alternator - Delco 25SI Series

75 Amp/24 Volt, Neg. Grd., wo/ pulley

Used On: Caterpillar, Clark, Cummins Engine, Dresser, Wabco

Replaces: Caterpillar 0R2415, 8N0999; Cummins 214318, 3604225RX; Delco 1117069, 1117238, 1117249, 1117256, 10459007; IHC 524023C91

Lester Nos: 7252

Features: 100% New

26SI Series



1-2301-00DR

(Ref# 8066N)

Alternator - Delco 26SI Series

85 Amp/12 Volt, Neg. Grd., wo/ pulley

Used On: Caterpillar, Cummins, Ford, International

Replaces: Delco 19010003, 19010014

Lester Nos: 8066

Note: Built w/ 46-1161 battery terminal (7/16-14 internal thread) and 46-1187 battery terminal adapter (1/4-28 external thread) provides multi application coverage w/ one unit. Simply use or remove adapter as required.

Features: 100% New

27SI/200 Series



20-124-1

(Ref# 7138N)

Alternator - Delco 27SI/200 Series

80 Amp/12 Volt, Neg. Grd., wo/ pulley

Used On: Allis-Chalmers, Caterpillar, Chevrolet Truck, Clark, Cummins Engine, GMC Truck, Hyster, International, Peterbilt, Terex, Volvo Truck, Western Star, White Trucks

Replaces: Caterpillar 0R5202, 9L5938; Cummins 3603851RX; ; Delco 1100072, 073, 080, 081, 086, 087, 089, 090, 185, 188, 188, 189, 189, 212, 212, 213, 213; 1101104, 104, 105, 105, 288; 1105460, 462, 463, 464, 465, 467, 469, 470

Lester Nos: 7138

Features: 100% New



20-125-1

(Ref# 274M, 7850N)

Alternator - Delco 27SI/200 Series

100 Amp/12 Volt, Neg. Grd., wo/ pulley

Used On: Caterpillar, Chevrolet Truck, GMC Truck, International-Navistar

Replaces: Caterpillar 0R2793, 9W1082; Cummins 3604659RX; Delco 1100091, 1100215, 1101287, 1105472, 1105473

Lester Nos: 7850

Features: 100% New

HEAVY DUTY & OFF ROAD

HEAVY DUTY & OFF ROAD

DELCO - ALTERNATORS

27SI/200 Series (cont'd)



20-126-1

(Ref# 7136N)

**Alternator - Delco 27SI/200 Series
80 Amp/12 Volt, Pos. Grd., wo/ pulley**

Used On: Autocar, Mack, Western, White Truck
Replaces: Cummins 3603852RX; Delco 1100075, 076, 082, 083, 088, 214; 1105461, 466, 468, 471
Lester Nos: 7136
Features: 100% New



20-127-1

(Ref# 7197N, 1049M)

**Alternator - Delco 27SI/200 Series
65 Amp/24 Volt, Neg. Grd., wo/ pulley**

Used On: Case, Clark, Cummins Engine, Drott, International, Terex
Replaces: Case A49652; Cummins 214169, 3920618, 603853RX; Delco 1100077, 1100093, 1100211, 1100274, 1105474, 1105475, 1105476; IHC 683594C91
Lester Nos: 7197
Features: 100% New

30SI Series



20-131-1

(Ref# 7262N)

**Alternator - Delco 30SI Series
90 Amp/12 Volt, Neg. Grd., wo/ pulley**

Used On: Case, Champion, Chevrolet Truck, Ford Truck, Freightliner, GMC Truck, International, Kenworth, Mack, Peterbilt, Volvo Truck, Western Star, White Truck
Replaces: Caterpillar OR1699; Cummins 3004806, 3604877RX; Delco 1117732, 1117736, 1117742, 1117800, 1117803, 1117804, 1117815
Lester Nos: 7262
Features: 100% New



20-132-1

(Ref# 7975N)

**Alternator - Delco 30SI Series
60 Amp/24 Volt, Neg. Grd., wo/ pulley**

Used On: Cummins Engines
Replaces: Delco 1117805, 1117831, 10459237
Lester Nos: 7975
Features: 100% New



20-133-1

**Alternator - Delco 30SI/TR Series
90A/12V, Neg. Grd., w/ Transformer Rectifier,
wo/ pulley**

Replaces: Delco 1117481, 1117483, 1117484, 1117744
Lester Nos: 7256
Features: 100% New



20-1163-1
(Ref# 7940N)

Alternator - Delco 30SI Series
105 Amp/12 Volt, Neg. Grd., wo/ pulley

Used On: Cummins Engine, Ford Truck, Freightliner, International, Kenworth, Mack, Peterbilt, Volvo Truck, Western Star

Replaces: Delco 1117801, 1117809, 1117811, 1117812, 1117813, 1117816; Ford FOHZ-10346-H

Lester Nos: 7940

Features: 100% New

31SI Series



1-2678-00DR

Alternator - Delco 31SI Series
200 Amp/12 Volt

Used On: Sterling Trucks

Replaces: Delco 19011104

Lester Nos: 8432

Dim: 5/16-18 Batt. Term.

Features: 100% New

33SI Series



1-2057-00DR-1
(Ref# 8083N)

Alternator - Delco 33SI Series
135 Amp/12 Volt, Neg. Grd.

Used On: Ford Truck, Freightliner, Kenworth, Volvo Truck,
(cont'd)

(cont'd)
Western Star

Replaces: Delco 19011152, 19011155, 19011156, 19011159, 19011161, 19011163, 19011173

Lester Nos: 8082, 8083

Dim: 1/4-28 Batt. Term.

Universal R-Term.

10-24 I-Term.

Note: Bidirectional Fan wo/ pulley

Features: 100% New



1-2077-00DR-1
(Ref# 8081N)

Alternator - Delco 33SI Series
110 Amp/12 Volt, Neg. Grd.

Used On: Ford Truck, Freightliner, International, Kenworth, Mack, Volvo Truck, Western Star

Replaces: Delco 19011150, 19011151, 19011154, 19011158, 19011160, 19011162, 19011174

Lester Nos: 8080, 8081

Dim: 1/4-28 Batt. Term.

Universal R-Term.

10-24 I-Term.

Note: Bidirectional Fan wo/ pulley

Features: 100% New



1-2558-00DR-1
(Ref# 8085N)

Alternator - Delco 33SI Series
100 Amp/24 Volt, Neg. Grd.

Replaces: Delco 19011153, 19011175

Lester Nos: 8085

Dim: 1/4-28 Batt. Term.

Universal R-Term.

10-24 I-Term.

Note: Bidirectional Fan wo/ pulley

Features: 100% New

HEAVY DUTY & OFF ROAD

HEAVY DUTY & OFF ROAD

DELCO - ALTERNATORS

34SI Series



1-2060-00DR-1

Alternator - Delco 34SI Series
110 Amp/12 Volt, Neg. Grd.

Used On: Ford Truck, Kenworth, Peterbilt, Volvo Truck, Western Star
Replaces: Delco 19011157
Lester Nos: 8090
Dim: 1/4-28 Batt. Term.
Universal R-Term.
10-24 I-Term.
Note: Bidirectional Fan wo/ pulley
Features: 100% New



1-2078-00DR-1

Alternator - Delco 34SI Series
135 Amp/12 Volt, Neg. Grd.

Used On: Caterpillar, Ford Truck, Kenworth, Peterbilt, Volvo Truck, Western Star
Replaces: Delco 19011167, 19011170
Lester Nos: 8092
Dim: 1/4-28 Batt. Term.
Universal R-Term.
10-24 I-Term.
Note: Bidirectional Fan wo/ pulley
Features: 100% New



1-2304-00DR-1

Alternator - Delco 34SI Series
135 Amp/12 Volt, Neg. Grd.

Used On: Freightliner
Replaces: Cummins 3675219RX; Delco 19011177, 10459285
Lester Nos: 8096
Dim: 1/4-28 Batt. Term.
Universal R-Term.
10-24 I-Term.
Note: Bidirectional Fan wo/ pulley
Features: 100% New



1-2680-00DR

Alternator - Delco 34SI Series
100 Amp/24 Volt, Neg. Grd.

Replaces: Delco 10459199, 19011168, 19011208
Lester Nos: 8094
Dim: 1/4-28 Batt. Term.
Universal R-Term.
10-24 I-Term.
Note: Bidirectional Fan wo/ pulley
Features: 100% New

35SI HP Series



1-2561-00DR

Alternator - Delco 35SI HP Series
140 Amp/12 Volt, Neg. Grd.

Replaces: Delco 8600065, 8700017
Lester Nos: 8608
Dim: 1/4-28 Batt. Term.
10-24 R-Term.
(cont'd)

(cont'd)
 10-24 I-Term.
 10-24 Remote Sense Term.
Note: Bidirectional Fan wo/ pulley
Features: 100% New



1-2562-00DR
Alternator - Delco 35SI HP Series
140 Amp/12 Volt, Neg. Grd.

Replaces: Delco 8600066, 8700018
Dim: 1/4-28 Batt. Term.
 10-24 R-Term., 10-24 I-Term.
 10-24 Remote Sense Term.
Note: Bidirectional Fan wo/ pulley
Features: 100% New



1-2563-00DR
Alternator - Delco 35SI HP Series
140 Amp/12 Volt, Neg. Grd.

Replaces: Delco 8600064, 8700016, 10459612, 19011260
Lester Nos: 8607
Dim: 1/4-28 Batt. Term.
 10-24 R-Term., 10-24 I-Term.
 10-24 Remote Sense Term.
Note: Bidirectional Fan wo/ pulley
Features: 100% New



1-2682-00DR
Alternator - Delco 36SI Series
170 Amp/12 Volt

Used On: Kenworth, Peterbilt Trucks
Replaces: Delco 8600125, 8700045
Lester Nos: 8613
Features: 100% New

AD230 Series



1-2197-21DR
 (Ref# 8238N)

Alternator - Delco AD230 Series
105 Amp/12 Volt, CW, 6-Groove Pulley

Used On: (1999) Chevrolet Silverado 4.3L, 4.8L, 5.3L, 6.0L
 (1999) GMC Sierra 4.3L, 4.8L, 5.3L, 6.0L
Replaces: Delco 10480229
Lester Nos: 8238
Components: 24-1272 Pulley
 D201XHD (35-160) P-L-I-S Regulator
Features: 100% New

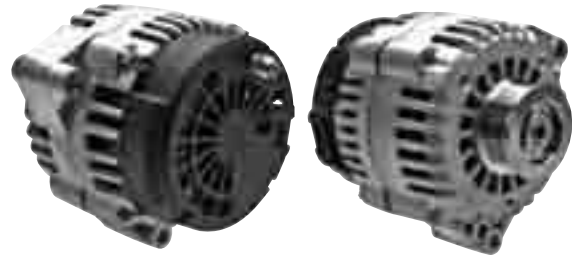

1-2320-21DR
 (Ref# 8291N)

Alternator - Delco AD230 Series
105A/12V, CW, 6-Groove Pulley, 3:30 Plug Clock

Used On: (2004-01) Chev. Astro, GMC Safari 4.3L
 (2004-02) Chev. Avalanche 5.3L, 8.1L
 (2004-01) Chev. Express, GMC Savana 4.3L, 5.0L, 5.7L, 6.0L,
 6.5L, 8.1L
 (2005-99) Chev. Silverado, GMC Sierra 4.3L, 4.8L, 5.3L, 6.0L,
 6.5L, 6.6L, 8.1L
 (2005-00) Chev. Suburban 5.3L, 6.0L, 8.1L
 (2005-00) Chev. Tahoe, GMC Yukon 4.8L, 5.3L, 6.0L, 8.1L
Replaces: Delco 10480326, 10480388, 15755616, 15768829
Lester Nos: 8247, 8273, 8291
Components: 24-1272 Pulley
 D200XHD (35-162) P-L-F-S Regulator
Features: 100% New

HEAVY DUTY & OFF ROAD

HEAVY DUTY & OFF ROAD

DELCO - ALTERNATORS

AD230 Series (cont'd)



1-2415-41DR

Alternator - Delco AD230 Series

105A/12V, CW, 7-Groove Pulley, 9:30 Plug Clock

Used On: (2002-01) Chevrolet Kodiak, GMC Topkick Trucks 8.1L

Replaces: Delco 10464459, 15769252

Lester Nos: 8490

Components: 24-1287 Pulley
D202XHD Regulator P-L-F-S Regulator

Features: 100% New

AD244 Series



1-2418-41DR

Alternator - Delco AD244 Series

130A/12V, CW, 7-Groove Pulley, 3:30 Plug Clock

Used On: (2002-01) Chevrolet Kodiak, GMC Topkick Trucks 8.1L

Replaces: Delco 10464460, 15769253

Lester Nos: 8492

Components: 24-1288 Pulley
D202XHD P-L-F-S Regulator

Features: 100% New



1-2419-21DR

Alternator - Delco AD244 Series

130-145A/12V, CW, 6-Groove Pulley, 12:00 Plug Clock

Used On: ((2005-99) Chevrolet, GMC Pickup, SUV, Van 4.3L, 4.8L, 5.3L, 6.0L, 6.5L, 6.6L, 8.1L

Replaces: Delco 10480234, 10480390, 15750871, 15754097, 15768830

Lester Nos: 8237, 8274, 8292

Components: 24-1272 Pulley
D200XHD (35-162) P-L-F-S Regulator

Features: 100% New

CS130 Series



20-142-11-1

(Ref# 7860N-3)

Alternator - Delco CS130 Series

100-105A/12V, CW, 6-Groove Pulley, 3:00 Plug Clock

Used On: (1989-87) Chevrolet Blazer, GMC Jimmy 2.8L

(1993-87) Chevrolet, GMC S, T Series Pickup 2.8L

(1993-90) GMC Sonoma 2.8L

Replaces: Delco 1101259, 10479920, 10479974

Lester Nos: 7860, 7880

Components: 24-1255-3 Pulley
D411XHD (35-127) P-L-I-S Regulator

Features: 100% New

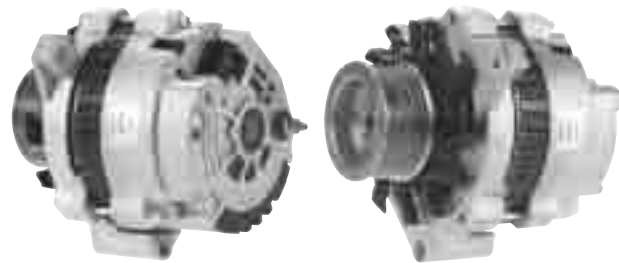

20-142-32-1

Alternator - Delco CS130 Series

100-105A/12V, CW, 6-Groove Pulley, 11:00 Plug Clock

Used On: (1990-87) Chevrolet Astro 2.5L

(1988-87) Chevrolet Blazer 2.5L

(1993-90) Chevrolet Post Office Vehicle 2.5L

(1993-87) Chevrolet S, T Series Pickup 2.5L

(1988-87) GMC Jimmy 2.5L

(1989-87) GMC S, T Series Pickup 2.5L

(1990-87) GMC Safari 2.5L

(1993-90) GMC Sonoma 2.5L

Replaces: Delco 1101346, 1101618, 1105722

Lester Nos: 7860, 7880

Components: 24-1250 Pulley
D411XHD (35-127) P-L-I-S Regulator

Features: 100% New

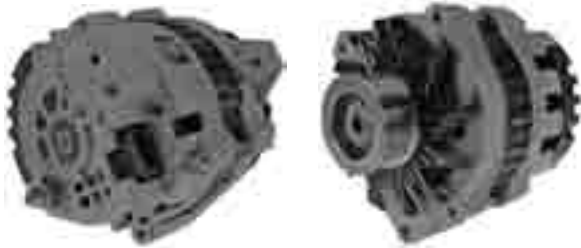

20-145-11-1
Alternator - Delco CS130 Series
100-105 Amp/12 Volt, CW, 6-Groove Pulley,
3:00 Plug Clock

Used On: (1992-90) Chevrolet Astro, GMC Safari 4.3L
 (1992) Chevrolet, GMC G Series Van 4.3L, 5.0L, 5.7L, 7.4L
Replaces: Delco 1101500, 1101521, 1101616, 1101617, 1101637
Lester Nos: 7861, 7921
Components: 24-1255-3 Pulley
 D411XHD (35-127) P-L-I-S Regulator
Features: 100% New



20-145-21-1
Alternator - Delco CS130 Series
100-105A/12V, CW, 6-Groove Pulley, 7:00 Plug Clock

Used On: (1993-88) Chevrolet Blazer, GMC Jimmy 4.3L, 5.7L
 (1993-90) Chevrolet C, K Series Pickup 4.3L, 5.0L, 5.7L
 (1991-90) Chevrolet, GMC R, V Series Pickup 5.7L
 (1993-88) Chevrolet, GMC S, T Series Pickup 4.3L
 (1993-89) Chevrolet, GMC Suburban 5.7L
 (1993-90) GMC Sierra 4.3L, 5.0L, 5.7L
 (1993-90) GMC Sonoma 4.3L
 (1993-92) GMC Yukon 5.7L
 (1993-91) Oldsmobile Bravada 4.3L
Replaces: Delco 1101293, 1101317, 1101318, 1101620, 1101628, 1101629, 10479802, 10479921, 10479922
Lester Nos: 7861, 7921, 7974, 7981
Components: 24-1255-3 Pulley
 D411XHD (35-127) P-L-I-S Regulator
Features: 100% New



20-145-31-1
Alternator - Delco CS130 Series
100-105A/12V, CW, 4-Groove Pulley, 11:00 Plug Clock

(cont'd)

(cont'd)

Used On: (1989-87) Chevrolet Astro, GMC Safari 4.3L
 (1990-88) Chevrolet, GMC C, K Series Pickup 4.3L, 5.0L, 5.7L
 (1992-87) Chevrolet, GMC G Series Van 4.3L, 5.0L, 5.7L
 (1990-89) GMC Sierra 4.3L, 5.0L, 5.7L
Replaces: Delco 1101582, 1105710, 10479993
Lester Nos: 7861, 7921
Components: 24-1264 Pulley
 D411XHD (35-127) P-L-I-S Regulator
Features: 100% New



20-152-11-1
 (Ref# 7802N-3)
Alternator - Delco CS130 Series
100-105A/12V, CW, 6-Groove Pulley, 3:00 Plug Clock

Used On: (1993-88) Chevrolet, GMC C, K Series Pickup 7.4L
 (1991-88) Chevrolet, GMC G Series Van 7.4L
 (1991-89) Chevrolet, GMC R, V Series Pickup 5.7L, 7.4L
 (1993-90) Chevrolet, GMC Suburban 7.4L
 (1993-89) GMC Sierra 7.4L
Replaces: Delco 1101619, 1101621, 1101630, 1101812, 1105688, 1105712, 1105716
Lester Nos: 7802, 7894
Components: 24-1255-3 Pulley
 D411XHD (35-127) P-L-I-S Regulator
Features: 100% New



20-152-22-1
 (Ref# 7802N-7)
Alternator - Delco CS130 Series
100-105A/12V, CW, 6-Groove Pulley, 7:00 Plug Clock

Used On: ((1990) Chevrolet, GMC P Series Step Van 4.3L
Replaces: Delco 1101125, 1101126, 1101150, 1101151, 1101464, 1105671, 1105672
Lester Nos: 7802, 7894
Components: 24-1250 Pulley
 D411XHD (35-127) P-L-I-S Regulator
Features: 100% New

DELCO - ALTERNATORS

CS130 Series (cont'd)

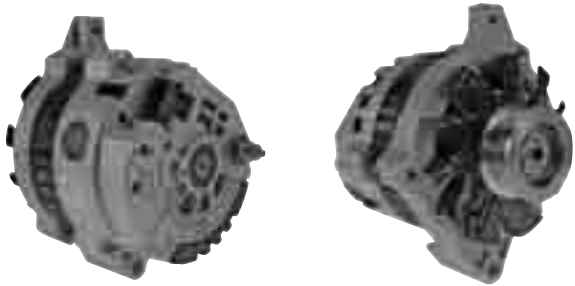

20-152-31-1

(Ref# 7802N-11)

Alternator - Delco CS130 Series

100-105A/12V, CW, 5-Groove Pulley, 11:00 Plug Clock

Used On: (1987) Chevrolet Blazer, GMC Jimmy 5.0L, 5.7L
(1993-87) Chevrolet, GMC P Series Step Van 4.3L, 5.7L
(1987) Chevrolet, GMC R, V Series Pickup 5.0L, 5.7L
(1988-87) Chevrolet, GMC Suburban 5.0L, 5.7L

Replaces: Delco 1101807, 1101815, 1105718, 1105720

Lester Nos: 7802, 7894

Components: 24-1257 Pulley
D411XHD (35-127) P-L-I-S Regulator

Features: 100% New

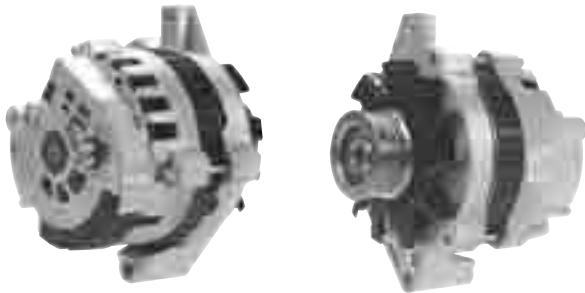

20-152-32-1

Alternator - Delco CS130 Series

100-105A/12V, CW, 6-Groove Pulley, 11:00 Plug Clock

Used On: (1993-88) Chevrolet, GMC P Series Step Van 7.4L
(1991-88) Chevrolet, GMC R, V Series Pickup 7.4L
(1988) Chevrolet, GMC Suburban 7.4L

Replaces: Delco 1101814, 1105661, 10479874, 10479883

Lester Nos: 7802

Components: 24-1255-3 Pulley
D411XHD (35-127) P-L-I-S Regulator

Features: 100% New

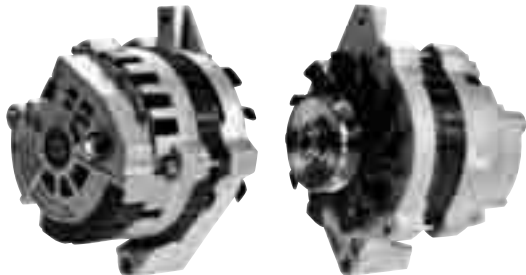

20-184-32

(Ref# 7977N)

Alternator - Delco CS130 Series

105A/12V, CW, 1-Groove Pulley, 11:00 Plug Clock

(cont'd)

(cont'd)

Used On: (1993-91) Chevrolet, GMC P Series Step Van 6.2L Diesel

Replaces: Delco 1101806

Lester Nos: 7977

Components: 24-1103 Pulley
D425XHD (35-124) P-L-I-S Regulator

Features: 100% New

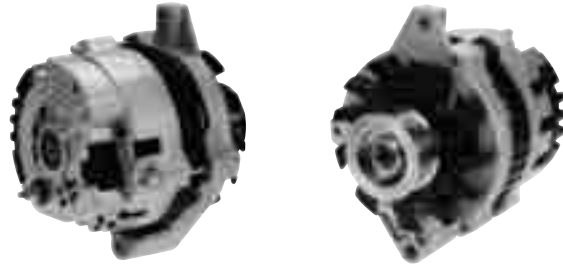

20-189-11-1

Alternator - Delco CS130 Series

105A/12V, CW, 6-Groove Pulley, 3:00 Plug Clock

Used On: (1993-90) Chev. Kodiak, GMC Topkick Truck 6.0L, 7.0L

Replaces: Delco 1101478, 1101480

Lester Nos: 7945, 7960

Components: 24-1255-3 Pulley
D425XHD (35-124) P-L-I-S Regulator

Features: 100% New



20-1132-12-1

(Ref# 8165N-3)

Alternator - Delco CS130 Series

100-105A/12V, CW, 6-Groove Pulley, 3:00 Plug Clock

Used On: (1993) Chevrolet Astro, GMC Safari 4.3L
(1996-92) Chevrolet, GMC G Series Van 4.3L, 5.0L, 5.7L, 7.4L

Replaces: Delco 10480069, 10480082, 10480087

Lester Nos: 8165

Components: 24-1255-3 Pulley
D411XHD (35-127) P-L-I-S Regulator

Features: 100% New



20-1132-22-1

Alternator - Delco CS130 Series

100-105A/12V, CW, 6-Groove Pulley, 7:00 Plug Clock

Used On: (1996-93) Chevrolet, GMC 4.3L, 5.0L, 5.7L, 6.5L, 7.4L

Replaces: Delco 10480084, 10480094

Lester Nos: 8165

Components: 24-1255-3 Pulley
D411XHD (35-127) P-L-I-S Regulator

Features: 100% New



20-1132-33-1

(Ref# 8165N-11)

Alternator - Delco CS130 Series

100-105A/12V, CW, 6-Groove Pulley, 11:00 Plug Clock

Used On: (1994) Chevrolet Blazer 6.5L
(1995-93) Chevrolet C, K Series Pickup 6.2L, 6.5L
(1995-94) Chevrolet, GMC Suburban 6.5L
(1995) Chevrolet Tahoe 6.5L
(1995-93) GMC Sierra 6.2L, 6.5L
(1995-94) GMC Yukon 6.5L

Replaces: Delco 10480086, 10480099

Lester Nos: 8165

Components: 24-1250 Pulley
D411XHD (35-127) P-L-I-S Regulator

Features: 100% New

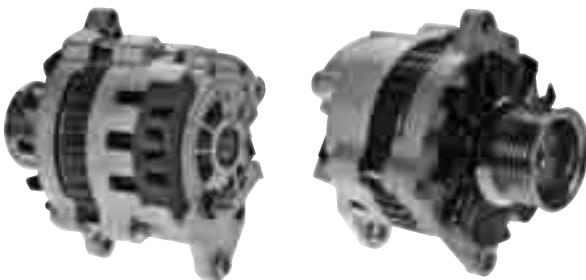

20-1138-11-1

Alternator - Delco CS130 Series

105A/12V, CW, 8-Groove Pulley, 3:00 Plug Clock

Used On: Freightliner

Replaces: Delco 10479976

Lester Nos: 7687

Components: 24-1276 Pulley
D425XHD (35-124) P-L-I-S Regulator

Features: 100% New



20-1142-31-1

(Ref# 8167N-11)

Alternator - Delco CS130 Series

105A/12V, CW, 6-Groove Pulley, 11:00 Plug Clock

Used On: (1995-94) Chevrolet, GMC P Series Step Van 4.3L, 5.7L, 7.4L

Replaces: Delco 10480090, 10480091

Lester Nos: 8167

Components: 24-1255-3 Pulley
D411XHD (35-127) P-L-I-S Regulator

Features: 100% New

CS130D Series

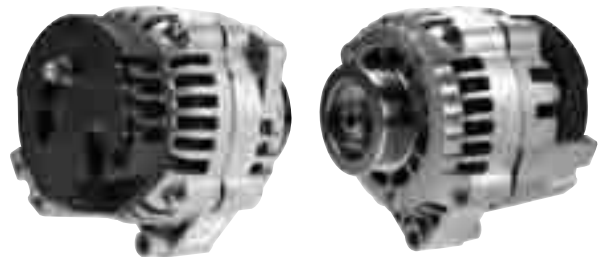

1-1802-21DR-1

(Ref# 8160N-5)

Alternator - Delco CS130D Series

100A/12V, CW, 6-Groove Pulley, 5:00 Plug Clock

Used On: (1995-94) Chevrolet Blazer, S, T Series Pickup 4.3L
(1995-94) GMC Jimmy 4.3L, Sonoma 4.3L
(1994) Oldsmobile Bravada 4.3L

Replaces: Delco 10479981, 10480188

Lester Nos: 8160

Components: 24-1271 Pulley
D702XHD (35-132) P-L-I-S Regulator

Features: 100% New

HEAVY DUTY & OFF ROAD

HEAVY DUTY & OFF ROAD

DELCO - ALTERNATORS

CS130D Series (cont'd)

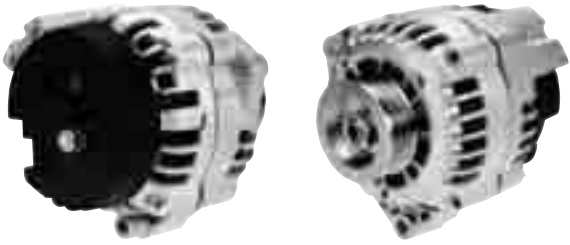

1-1802-31DR-1
(Ref# 8160N-7)

Alternator - Delco CS130D Series

100A/12V, CW, 6-Groove Pulley, 8:00 Plug Clock

Used On: (1997-94) Chevrolet S, T Series Pickup 2.2L
(1997-94) GMC Sonoma 2.2L

Replaces: Delco 10479984, 10480187

Lester Nos: 8160

Components: 24-1271 Pulley
D702XHD (35-132) P-L-I-S Regulator

Features: 100% New

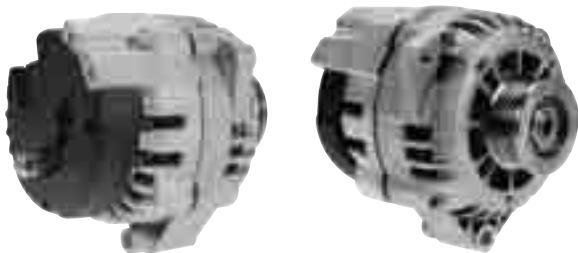

1-1802-42DR-1
(Ref# 8160N-11)

Alternator - Delco CS130D Series

100-105A/12V, CW, 6-Groove Pulley, 11:00 Plug Clock

Used On: (1995-94) Chevrolet Astro, GMC Safari 4.3L

Replaces: Delco 10480017, 10480072, 10480189, 10480190

Lester Nos: 8160

Components: 24-1272 Pulley
D702XHD (35-132) P-L-I-S Regulator

Features: 100% New

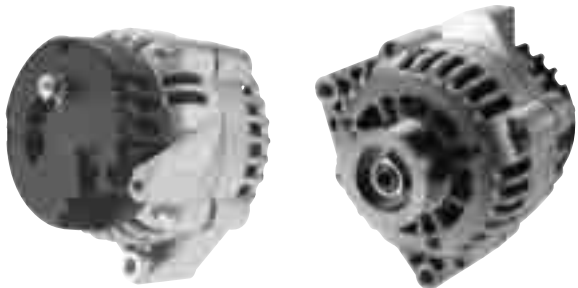

1-1995-21DR-1
(Ref# 8206N)

Alternator - Delco CS130D Series

105A/12V, CW, 6-Groove Pulley, 5:00 Plug Clock

Used On: (2000-96) Chevrolet, GMC Pickups, SUV, Vans 4.3L,
5.0L, 5.7L, 6.5L, 7.4L

Replaces: Delco 10480167, 10480168, 10480198

Lester Nos: 8206

(cont'd)

(cont'd)

Components: 24-1272 Pulley
D702XHD (35-132) P-L-I-S Regulator

Features: 100% New



1-1995-22DR

Alternator - Delco CS130D Series

100A/12V, CW, 6-Groove Pulley, 5:00 Plug Clock

Used On: (2000-97) Chev. C, K Series; GMC Sierra 6.5L Diesel
(2000-99) Chev. Express, GMC Savana 6.5L Diesel
(1999-97) Chevrolet, GMC Suburban 6.5L Diesel
(1999-97) Chevrolet Tahoe 6.5L Diesel

Replaces: Delco 10463940

Lester Nos: 8227

Components: 24-1285 Pulley w/ Taper Collar
D702XHD (35-132) P-L-I-S Regulator

Features: 100% New



1-2042-21DR-1
(Ref# 8216N)

Alternator - Delco CS130D Series

100-105A/12V, CW, 6-Groove Pulley, 5:00 Plug Clock

Used On: (1999-96) Chevrolet, GMC Step Van 4.3L, 5.7L, 6.5L,
7.4L

Replaces: Delco 10480170

Lester Nos: 8216

Components: 24-1272 Pulley
D706XHD (35-138) P-L-I-S Regulator

Features: 100% New

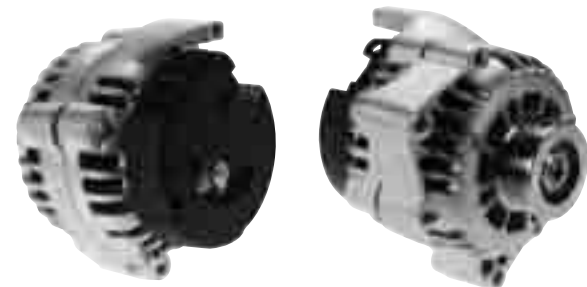

1-2156-21DR-1
(Ref# 8231N)

Alternator - Delco CS130D Series

100-105A/12V, CW, 6-Groove Pulley, 5:00 Plug Clock

Used On: (2000) Chevrolet Astro 4.3L

(cont'd)

(cont'd)

(1999-98) Chevrolet Blazer 4.3L
 (2000-98) Chevrolet S, T Series Pickup 4.3L
 (1999-98) GMC Jimmy 4.3L
 (2000) GMC Safari 4.3L
 (2000-98) GMC Sonoma 4.3L

Replaces: Delco 10480251, 10480254

Lester Nos: 8231

Components: 24-1272 Pulley

D705XHD (35-137) P-F-S Regulator

Features: 100% New



1-2175-31DR-1

(Ref# 8233N)

Alternator - Delco CS130D Series

100A/12V, CW, 6-Groove Pulley, 8:00 Plug Clock

Used On: (2003-98) Chevrolet S, T Series Pickup 2.2L

(2003) Chevrolet S, T Series Pickup 4.3L

(2003-98) GMC Sonoma 2.2L

(2003) GMC Sonoma 4.3L

Replaces: Delco 10480252

Lester Nos: 8233

Components: 24-1271 Pulley

D705XHD (35-137) P-L-F-S Regulator

Features: 100% New



1-2398-11DR

(Ref# 8283N)

Alternator - Delco CS130D Series

100A/12V, CW, 6-Groove Pulley, 1:00 Plug Clock

Used On: (2005-00) Chevrolet Blazer 4.3L

(2004-00) Chev. S, T Series Pickup 4.3L

(2001) Chev. Trailblazer, GMC Envoy 4.3L

(2001-00) GMC Jimmy 4.3L

(2004-00) GMC Sonoma 4.3L

Replaces: Delco 10480288, 15760058

Lester Nos: 8283

Components: 24-1272 Pulley

D749XHD (35-157) P-L-F-S Regulator

Features: 100% New

CS144 Series



1-2037-21DR

(Ref# 8209N)

Alternator - Delco CS144 Series

124A/12V, CW, 6-Groove Pulley, 4:30 Plug Clock

Used On: (1999-96) Chevrolet, GMC P Series Step Van 5.7L, 6.5L, 7.4L

Replaces: Delco 10480156, 10480267

Lester Nos: 8209

Components: 24-1255-3 Pulley

D425 (35-124) P-L-I-S Regulator

Features: 100% New



20-175-11

(Ref# 7901N)

Alternator - Delco CS144 Series

124A/12V, CW, 6-Groove Pulley, 1:30 Plug Clock

Used On: (1994-92) Chevrolet Blazer 5.7L

(1995-91) Chevrolet C, K Series Pickup 5.0L, 5.7L

(1993-92) Chevrolet Corvette 5.7L

(1989) Chevrolet, GMC R, V Series Pickup 7.4L

(1995-93) Chevrolet, GMC Suburban 5.7L

(1989) Chevrolet, GMC Suburban 7.4L

(1995) Chevrolet Tahoe 5.7L

(1995-91) GMC Sierra 5.0L, 5.7L

(1995-92) GMC Yukon 5.7L

Replaces: Delco 1101491, 1102634, 1102642

Lester Nos: 7901

Components: 24-1255-3 Pulley

D411 (35-127) P-L-I-S Regulator

Features: 100% New

HEAVY DUTY & OFF ROAD

HEAVY DUTY & OFF ROAD

DELCO - ALTERNATORS

CS144 Series (cont'd)



20-1105-41

(Ref# 7678N)

Alternator - Delco CS144 Series

145A/12V, CW, 6-Groove Pulley, 10:30 Plug Clock

Used On: (1993-92) Chevrolet B7, P6 Series Truck 6.0L, 7.0L
(1996-91) Chevrolet Kodiak, GMC Topkick Truck 6.0L, 7.0L

Replaces: Delco 10480022, 10480023

Lester Nos: 7678, 7684

Components: 24-1255-3 Pulley

D425 (35-124) P-L-I-S Regulator

Features: 100% New



20-1156-21

Alternator - Delco CS144 Series

140A/12V, CW, 6-Groove Pulley, 4:30 Plug Clock

Used On: (2000-96) Chevrolet, GMC 4.3L, 5.0L, 5.7L, 6.5L, 7.4L

Replaces: Delco 10480130, 10480133, 10480206, 10480255

Lester Nos: 8203, 8219

Components: 24-1255-3 Pulley

D411 (35-127) P-L-I-S Regulator

Features: 100% New

DR44G Series



1-2556-21DR

Alternator - Delco DR44G Series

145 Amp/12 Volt, CW, 6-Groove Pulley

Used On: (2006-05) Chevrolet Avalanche 8.1L

(2007-05) Chev. Express, GMC Savana 4.3L, 4.8L, 5.3L, 6.0L, 6.6L

(2006) Chev. Silverado, Suburban; GMC Sierra, Yukon 6.0L, 8.1L

(2006) Hummer H2 6.0L

(cont'd)

(cont'd)

Replaces: Delco 15200109

Lester Nos: 8292



photo not available

1-2928-01DR

Alternator - Delco DR44G Series

150 Amp/12 Volt

Used On: (2007-06) Chevrolet, GMC Medium Duty Trucks

Replaces: Delco 93441577, 94665498

DELCO - STARTERS

14MT Series



2-2748-DR-2

Starter - Delco 14MT Series

12 Volt, CW

Used On: Hyster

Replaces: Delco 19010612

Features: 100% New

27MT Series

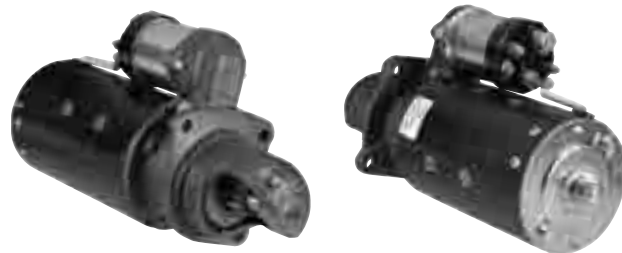

50-157-9

Starter - Delco 27MT Series

12 Volt, CW, 10-Tooth Pinion

Used On: (1984-83) Ford E, F Series Van, Pickup 6.9L

Replaces: Delco 1998408, 1998423, 1998457

Lester Nos: 3300

Note: Remanufactured. For 28MT design use 50-8420.

28MT Series



2-1580-DR
(Ref# 6468N, S7055M)
Starter - Delco 28MT Series
12 Volt, CW, 10-Tooth Pinion

Used On: (1991-89) Chev. Blazer, GMC Jimmy 6.2L w/ AT (1994) Chev. Blazer, GMC Yukon 6.5L (1993-89) Chev. C, K Series Pickup, GMC Sierra 6.2L w/ AT (1994-92) Chev. C, K Series Pickup, GMC Sierra 6.5L w/ AT (1991-89) Chev., GMC R, V Series Pickup 6.2L w/ AT (1991-89) Chev., GMC Suburban 6.2L w/ AT (1994) Chev., GMC Suburban 6.5L
Replaces: Delco 1113266, 1113269, 1113295
Lester Nos: 6468
Features: 100% New



2-2051-DR
(Ref# 79637N)
Starter - Delco 28MT Series
12 Volt, CW, 10-Tooth Pinion

Used On: Cummins Diesel Engines
Replaces: Delco 10461474, 10479634; Ford F7HT-11001-AB, -AC; F7HZ-11002-AB
Lester Nos: 6603
Note: Dry clutch, M10 x 1.5 ground stud, 32mm pinion OD. Similar to 50-8420 (Lester 6573, 6583) except 50-8420 wo/ ground stud.



50-8402-2
(Ref# 6469N)
Starter - Delco 28MT Series
12 Volt, CW, 10-Tooth Pinion

Used On: (2002-89) Chevrolet, GMC Pickup, SUV, Van 6.2L, 6.5L (Diesel)
Replaces: Delco 1113267, 1113270, 1113296
Lester Nos: 6469
Note: Dry clutch, 3-terminal solenoid, 32mm pinion OD. Also replaces 27MT series 1109219, 1109563, 1113589, 1998442 (50-105-9).
Features: 100% New



50-8403
(Ref# 6417N)
Starter - Delco 28MT Series
12 Volt, CW, 12-Tooth Pinion

Used On: Bobcat, Clark, Ford New Holland, Hyster, Lister-Petter, Perkins
Replaces: Delco 1113273
Lester Nos: 6571
Note: Dry clutch, 3-terminal solenoid, 32mm pinion OD. Similar to 50-8426 except 50-8426 is wet clutch, w/ 4-terminal solenoid. Also replaces 20-27MT series 1107588, 1113598, 1998339, 1998347, 1998455.
Features: 100% New

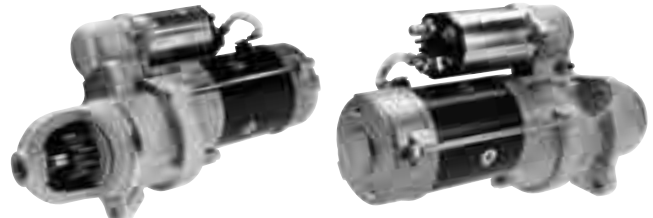

50-8404
(Ref# 6425N)
Starter - Delco 28MT Series
12 Volt, CW, 10-Tooth Pinion

Used On: Bobcat, Clark, Deutz, Ford New Holland, Massey Ferguson, Perkins
Replaces: Delco 1113281, 1113282
Lester Nos: 6576
Note: Dry clutch, 3-terminal solenoid, 40mm pinion OD. Also replaces 22-27MT series 1109253, 1109263, 1998330, 1998342, 1998376.
Features: 100% New



50-8405
(Ref# 6572N)
Starter - Delco 28MT Series
12 Volt, CW, 10-Tooth Pinion

Used On: Lincoln Welder, New Holland, Perkins
Replaces: Delco 1113274, 10465044; IHC 121913C91
Lester Nos: 6572
Features: 100% New

HEAVY DUTY & OFF ROAD

HEAVY DUTY & OFF ROAD

DELCO - STARTERS

28MT Series (cont'd)



50-8406-2

(Ref# 6584N)

**Starter - Delco 28MT Series
12 Volt, CW, 10-Tooth Pinion**

Used On: Hyster, Lincoln Welder, Perkins

Replaces: Delco 1113275, 1113278

Lester Nos: 6584

Note: Dry clutch, 3-terminal solenoid, 40mm pinion OD.
Also replaces 22-27MT series 1998336, 383, 87, 481.

Features: 100% New



50-8407

(Ref# 6573N, S7051M)

**Starter - Delco 28MT Series
12 Volt, CW, 10-Tooth Pinion**

Used On: Freightliner, Kenworth, Mercury Mercruiser, Sterling, White Ag, Industrial, Marine & Truck applications w/ Cummins 3.9L, 5.9L Diesel Engines

Replaces: Cummins 3604654RX, 3916854; Delco 1113276, 10479621; Mercury Marine 50-805991; Prestolite 35258940

Lester Nos: 6573

Features: 100% New



50-8410

(Ref# 6575N)

**Starter - Delco 28MT Series
12 Volt, CW, 12-Tooth Pinion**

Used On: Allis-Chalmers, Bobcat, Clark, Cummins 3.9L, Perkins

Replaces: Delco 1113279, 1113280

Lester Nos: 6575

Note: Dry clutch, 3-terminal solenoid, 46.5mm pinion OD.
Also replaces 22-27MT series 1109272; 1998334, 338, 378.

Features: 100% New



50-8415

(Ref# 6593N)

**Starter - Delco 28MT Series
12 Volt, CW, 10-Tooth Pinion**

Used On: Miller Electric w/ Teledyne 2.0, 2.7L Engines

Replaces: Delco 1113297

Lester Nos: 6593

Note: Dry clutch, 3-terminal solenoid, 40mm pinion OD.
Also replaces 22MT series 1113599.

Features: 100% New



50-8417

(Ref# 6588N)

**Starter - Delco 28MT Series
12 Volt, CW, 10-Tooth Pinion**

Used On: Hyster Lift Trucks w/ Perkins 6-354 Engine

Replaces: Delco 1113290

Lester Nos: 6588

Note: Wet clutch (replaces dry clutch applications), 3-terminal solenoid, 40mm pinion OD. Also replaces 27MT series 1998468.

Features: 100% New

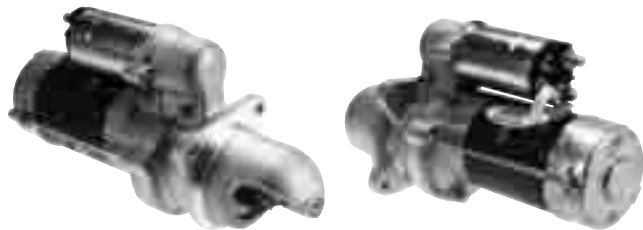

50-8418

(Ref# 6594N)

**Starter - Delco 28MT Series
24 Volt, CW, 10-Tooth Pinion**

Used On: Detroit Diesel

Replaces: Delco 10479605

Lester Nos: 6594

Note: Dry clutch, 3-terminal solenoid, 40mm pinion OD.

Features: 100% New



50-8419
(Ref# 6590N)
Starter - Delco 28MT Series
12 Volt, CW, 10-Tooth Pinion

Used On: Oshkosh
Replaces: Delco 10479604
Lester Nos: 6590
Note: Dry clutch, 3-terminal solenoid, 32mm pinion OD.
Features: 100% New



50-8420
(Ref# 6583N)
Starter - Delco 28MT Series
12 Volt, CW, 10-Tooth Pinion

Used On: Consolidated Diesel, Cummins 3.9L, 5.9L, Freightliner, Kenworth, White Farm Equipment
Replaces: Delco 1113276, 1113292
Lester Nos: 6573, 6583
Note: Wet clutch (replaces dry clutch applications), 3-terminal solenoid, 32mm pinion OD.
Also replaces 27MT series 1998522.
Interchangeable with 2-1254-MI, 2-1726-ND, 2-1747-MI, 50-8437-1 (Lester Nos. 16658, 17037, 17577)
Features: 100% New



50-8421
(Ref# 6582N)
Starter - Delco 28MT Series
24 Volt, CW, 10-Tooth Pinion

Used On: Consolidated Diesel, Cummins, Dresser, Timberjack
Replaces: Delco 1113277, 1113291
Lester Nos: 6574, 6582
Note: Wet clutch (replaces dry clutch applications), 3-terminal solenoid, 32mm pinion OD.
Similar to 50-8434 except 50-8434 w/ 4-terminal solenoid.
Also replaces 27MT series 1998488.
Features: 100% New



50-8422
(Ref# 6570N)
Starter - Delco 28MT Series
12 Volt, CW, 10-Tooth Pinion

Used On: Bobcat, Clark, John Deere Farm & Industrial Equipment
Replaces: Delco 1113271
Lester Nos: 6570
Note: Dry clutch, 4-terminal solenoid (4th terminal is dummy terminal), 32mm pinion OD.
Similar to 50-8438 except 50-8438 has D.E. housing w/ 1/2-13 ground boss.
Also replaces Delco 27MT Series 1998367 (Lester 4000) and Bosch 0-001-359-090 (Lester 16563) starters.
Features: 100% New



50-8423
Starter - Delco 28MT Series
12 Volt, CW, 10-Tooth Pinion

Used On: Clark Lift Trucks w/ Perkins Engine
Replaces: Delco 1113288
Lester Nos: 6581
Note: Wet clutch, 3-terminal solenoid, 40mm pinion OD.
Also replaces 22MT series 1998389 (Lester 6168)
Features: 100% New



50-8424
(Ref# 6591N)
Starter - Delco 28MT Series
24 Volt, CW, 12-Tooth Pinion

Used On: Lister-Petter
Replaces: Delco 10479600
Lester Nos: 6591
Note: Dry clutch, 4-terminal solenoid.
Also replaces 22MT series 1998351.
Features: 100% New

HEAVY DUTY & OFF ROAD

HEAVY DUTY & OFF ROAD

DELCO - STARTERS

28MT Series (cont'd)



50-8425

(Ref# 6585N)

**Starter - Delco 28MT Series
12 Volt, CW, 10-Tooth Pinion**

Used On: Ford Trucks w/ Cummins 5.9L or FD-1060 Diesel Engines, w/ Allison AT

Replaces: Delco 10479615, 10479618

Lester Nos: 6585

Note: Dry clutch, 4-terminal solenoid (4th terminal is dummy terminal), 32mm pinion OD.

Features: 100% New



50-8426

(Ref# 6586N)

**Starter - Delco 28MT Series
12 Volt, CW, 12-Tooth Pinion**

Used On: Bobcat, Clark Skid Steer Loader w/ Kubota V2203E Engine

Replaces: Delco 10479613

Lester Nos: 6586

Note: Wet clutch, 4-terminal solenoid, 46.5mm pinion OD. Similar to 50-8403 except 50-8403 is dry clutch, w/ 3-terminal solenoid.

Features: 100% New



50-8428

(Ref# 6595N)

**Starter - Delco 28MT Series
12 Volt, CW, 10-Tooth Pinion**

Used On: Ford Trucks w/ Cummins 5.9L or FD-1060 Diesel Engines, wo/ Allison AT

Replaces: Delco 10479614

Lester Nos: 6595

Note: Dry clutch, 4-terminal solenoid (4th terminal is dummy terminal), 32mm pinion OD

Features: 100% New



50-8429

(Ref# 6578N)

**Starter - Delco 28MT Series
12 Volt, CW, 10-Tooth Pinion**

Used On: Bobcat, Clark Skid Steer Loader w/ Isuzu or Perkins 4-236 Engines

Replaces: Delco 1113285

Lester Nos: 6578

Note: Wet clutch, 4-terminal solenoid (4th terminal is dummy terminal), 40mm pinion OD.

Also replaces 27MT series 1998379 (Lester 6179).

Features: 100% New

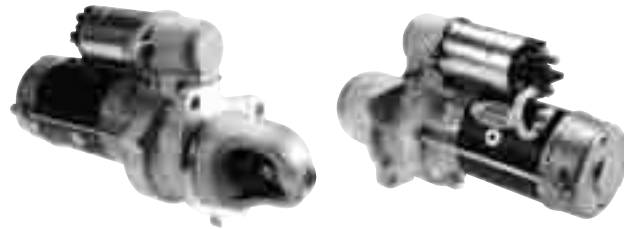

50-8431

(Ref# 6587N)

**Starter - Delco 28MT Series
12 Volt, CW, 10-Tooth Pinion**

Used On: Allis-Chalmers, Ford New Holland, Lincoln Welder, Massey Ferguson, Perkins, White

Replaces: Delco 1113274, 10479607

Lester Nos: 6572, 6587

Note: Dry clutch, 4-terminal solenoid, 40mm pinion OD.

Features: 100% New



50-8432

(Ref# 6597N)

**Starter - Delco 28MT Series
24 Volt, CW, 10-Tooth Pinion**

Used On: Lister-Petter

Replaces: Delco 10479608

Lester Nos: 6597

Note: Dry clutch, 4-terminal solenoid, 40mm pinion OD.

Features: 100% New



50-8433
(Ref# 6598N)

Starter - Delco 28MT Series
24 Volt, CW, 10-Tooth Pinion

Used On: Military Equipment w/ 6.2L GM Diesel Engine
Replaces: Delco 10479611
Lester Nos: 6598
Note: Dry clutch, 3-terminal solenoid, 32mm pinion OD
Features: 100% New



50-8437
(Ref# 6589N)

Starter - Delco 28MT Series
12 Volt, CW, 10-Tooth Pinion

Used On: Bobcat, Consolidated Diesel, Freightliner, White Farm Equipment w/ Cummins 3.9L, 5.9L Engines
Replaces: Delco 10479617, 10479621
Lester Nos: 6573, 6589
Note: Wet clutch, 4-terminal solenoid, 32mm pinion OD. Interchangeable with 2-1254-MI, 2-1726-ND, 2-1747-MI, 50-8420-1 (Lester Nos. 16658, 17037, 17577)
Features: 100% New



50-8434
(Ref# 6592N)

Starter - Delco 28MT Series
24 Volt, CW, 10-Tooth Pinion

Used On: Champion Grader w/ Cummins 5.9L Engine
Replaces: Delco 1113277, 10479616
Lester Nos: 6592
Note: Wet clutch (replaces dry clutch applications), 4-terminal solenoid, 32mm pinion OD. Similar to 50-8421 except 50-8421 w/ 3-terminal solenoid.
Features: 100% New



50-8438
(Ref# 6601N)

Starter - Delco 28MT Series
12 Volt, CW, 10-Tooth Pinion

Used On: John Deere Industrial Equipment
Replaces: Delco 10479628
Lester Nos: 6601
Note: D.E. housing w/ 1/2-13 ground boss, dry clutch, 4-terminal solenoid (4th terminal is dummy terminal), 32mm pinion OD. Similar to 50-8422 except 50-8422 has D.E. housing wo/ threaded ground boss.
Features: 100% New

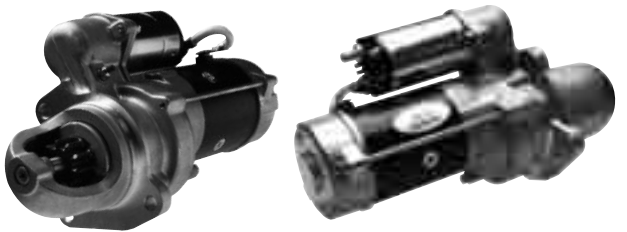

50-8436
(Ref# 6600N)

Starter - Delco 28MT Series
12 Volt, CW, 10-Tooth Pinion

Used On: Hough International
Replaces: Delco 1113284
Lester Nos: 6600
Note: Dry clutch, 3-terminal solenoid, 40mm pinion OD
Features: 100% New



50-8441
(Ref# 79606N)

Starter - Delco 28MT Series
12 Volt, CW, 12-Tooth Pinion

Used On: Lister-Petter
Replaces: Delco 10479606
Note: Dry clutch, 3-terminal solenoid, 46.5mm pinion OD
Features: 100% New, mfd. by OE supplier

DELCO - STARTERS

29MT Series



2-2357-DR-1

**Starter - Delco 29MT Series
12 Volt, CW, 10-Tooth Pinion**

Used On: Freightliner w/ Cummins ISB Engine
Replaces: Delco 8200010, 10461770, 19011400
Lester Nos: 6840
Features: 100% New



2-2389-DR

(Ref# 61772N)

**Starter - Delco 29MT Series
12 Volt, CW, 9-Tooth Pinion**

Used On: Freightliner w/ Mercedes Engines
Replaces: Delco 8200011, 8200103, 10461772, 19011403
Lester Nos: 6842
Features: 100% New



2-2391-DR

(Ref# 11409N)

**Starter - Delco 29MT Series
12 Volt, CW, 10-Tooth Pinion**

Used On: International w/ Cummins ISB Engines
Replaces: Delco 10461765, 19011409; Ford 4C4Z-11002-CA
Lester Nos: 6844
Features: 100% New



2-2704-DR-2

(Ref# 11402N)

**Starter - Delco 29MT Series
12 Volt, CW, 10-Tooth Pinion**

Used On: Freightliner, Sterling Trucks
Replaces: Delco 8200067, 10461771, 19011402
Lester Nos: 6841
Features: 100% New

37MT Series



2-1582-DR-1

(Ref# 6504N)

**Starter - Delco 37MT Heavy Duty Positive Engagement
12 Volt, CW, 10-Tooth Pinion, w/ Thermostat**

Used On: (2002-90) Chev. Kodiak, GMC Topkick 6.6L, 7.2L Diesel
Replaces: Delco 1993947
Lester Nos: 6504
Dim: 1/2-13 C.E. Terminal
Note: Field case w/ grd. terminal stud. Solenoid positioned at 308°.
Features: 100% New, heavy duty positive engagement solution for 37MT starters



2-1584-DR-2

(Ref# 6386N)

**Starter - Delco 37MT Series
12 Volt, CW, 12-Tooth Pinion**

Used On: (1993-92) Chevrolet Truck P6 Series 6.6L
Replaces: Delco 1990310, 1993964
Lester Nos: 6386
Features: 100% New



2-2206-DR-1
(Ref# 6297N)

**Starter - Delco 37MT Heavy Duty Positive Engagement
12 Volt, CW, 10-Tooth Pinion**

Used On: International-Navistar Trucks 7.3L T-444E Diesel
Replaces: Delco 10478890
Lester Nos: 6297
Dim: 1/2-13 C.E. Terminal
Note: Solenoid positioned at 278°
Features: 100% New, heavy duty positive engagement solution for 37MT starters



2-2207-DR-1
(Ref# 6269N)

**Starter - Delco 37MT Heavy Duty Positive Engagement
24 Volt, CW, 10-Tooth Pinion**

Used On: Cummins Engine, Kobelco America Equipment
Replaces: Cummins 3908594, Delco 1993903
Lester Nos: 6269
Note: Solenoid positioned at 322°
Features: 100% New, heavy duty positive engagement solution for 37MT starters



2-2470-DR

Starter - Delco 37MT Series

12 Volt, CW, 10-Tooth Pinion, w/ Thermostat

Used On: Ford Truck w/ Cummins 8.3L Diesel
Replaces: Delco 10478953
Lester Nos: 6464
Dim: 1/2-13 C.E. Terminal
Note: Solenoid positioned at 128°
Features: 100% New



50-113-1
(Ref# 6348N)

**Starter - Delco 37MT Heavy Duty Positive Engagement
12 Volt, CW, 10-Tooth Pinion**

Used On: Chevrolet Truck, GMC Truck, Ford Truck
Replaces: Delco 1990308; 1993738, 759, 789, 850, 855
Lester Nos: 6348
Note: Field case w/ grd. terminal stud. Solenoid positioned at 68°
Features: 100% New, heavy duty positive engagement solution for 37MT starters

37MT HEAVY DUTY POSITIVE ENGAGEMENT STARTERS

- 100% New
- Eliminates the stop ring & stop collar failure common on the 37MT design
- 41MT Maxitork, positive-engagement drive
- 41MT heat treated armature with straight splines and welded steel core riserless commutator
- 41MT solenoid, 100% tested for coil strength, voltage drop across contacts and 'reserve burnoff' on the contacts
- Varnish dipped field coils
- Ductile iron D.E. housing
- Painted gloss black with zinc-yellow plated hardware
- 100% computerized load tested



HEAVY DUTY & OFF ROAD

HEAVY DUTY & OFF ROAD

DELCO - STARTERS

37MT Series (cont'd)



50-158-1

(Ref# 6391N)

**Starter - Delco 37MT Heavy Duty Positive Engagement
12 Volt, CW, 10-Tooth Pinion**

Used On: Ford Trucks, International-Navistar Trucks

Replaces: Delco 1990312, 1993761, 1993818, 1993880

Lester Nos: 6391

Note: Solenoid positioned at 278°

Features: 100% New, heavy duty positive engagement solution for 37MT starters



50-159-1

(Ref# 6387N)

**Starter - Delco 37MT Heavy Duty Positive Engagement
12 Volt, CW, 10-Tooth Pinion**

Used On: John Deere, White Farm Tractors

Replaces: Delco 1113402, 640, 641, 644, 650, 651, 653, 656, 672, 676, 690; 1990315, 318, 326; 1993754, 762, 799, 881

Lester Nos: 6387, 6410, 16635*

Note: Solenoid positioned at 52°

*Also replaces Nippondenso 028000-329, 028000-504 starters.

Features: 100% New, heavy duty positive engagement solution for 37MT starters



50-160-1

(Ref# 6241N)

**Starter - Delco 37MT Heavy Duty Positive Engagement
24 Volt, CW, 12-Tooth Pinion**

Used On: Clark, Cummins 8.3L, Detroit Diesel 3-53, Lister Diesel, Waukesha

Replaces: Delco 1990330, 1990332, 1993707, 1993729, 1993732, 1993901, 1993902, 1993909, 1993910, 10479175

Lester Nos: 6292, 6293, 6358, 6359

(cont'd)

(cont'd)

Note: Solenoid positioned at 308°

Also replaces Delco 35MT 1113403, 1113536

Features: 100% New, heavy duty positive engagement solution for 37MT starters



50-161-1

(Ref# 6382N)

**Starter - Delco 37MT Heavy Duty Positive Engagement
12 Volt, CW, 10-Tooth Pinion**

Used On: Clark Equipment w/ Perkins 4-248, 6-354 Diesel; Ford Trucks 6.6L, 7.8L Diesels; International Tractors D-246 Diesel

Replaces: Delco 1990309, 1993769, 1993886, 10461003

Lester Nos: 6382

Features: 100% New, heavy duty positive engagement solution for 37MT starters



50-162-1

**Starter - Delco 37MT Heavy Duty Positive Engagement
12 Volt, CW, 12-Tooth Pinion**

Used On: Cummins, International-Navistar, Waukesha Motors

Replaces: Cummins 3910643; Delco 1990316, 317, 319; 1993713, 763, 778, 794, 871, 874, 931; 10461008

Lester Nos: 6380

Note: Solenoid positioned at 82°

Features: 100% New, heavy duty positive engagement solution for 37MT starters



50-193-1

(Ref# 6398N)

**Starter - Delco 37MT Heavy Duty Positive Engagement
12 Volt, CW, 10-Tooth Pinion**

Used On: Ford Truck 6.6L, 7.8L Diesel

Replaces: Delco 1990347; 1993767, 854; Ford E5HT-11001-AA, E6HZ-11002-A, E9HT-11001-BA, E9HZ-11002-A

Lester Nos: 6398

Note: Solenoid positioned at 300°

Features: 100% New, heavy duty positive engagement solution for 37MT starters



50-194-1
(Ref# 6505N)

Starter - Delco 37MT Heavy Duty Positive Engagement
12 Volt, CW, 10-Tooth Pinion

Used On: Chevrolet, GMC Medium Duty Trucks w/ Cat 3116 Diesel 6.6L; Freightliner Medium Duty Trucks w/ Cat 3126 Diesel
Replaces: Delco 1993963, 10461081
Lester Nos: 6505
Dim: 1/2-13 C.E. terminal
Features: 100% New, heavy duty positive engagement solution for 37MT starters



2-2377-DR-1
(Ref# 6807N)

Starter - Delco 38MT Series
12 Volt, CW, 10-Tooth Pinion

Used On: Caterpillar 3126/C7, Freightliner
Replaces: Delco 8300021, 8200076, 10461768, 19026027
Lester Nos: 6807
Note: Solenoid positioned at 128°
Features: 100% New w/ IMS (Integral Magnetic Switch)

2-2377-DR

Starter - Delco 38MT Series

Note: Same as 2-2377-DR-1 except mfd. by OE supplier w/ IMS (Integral Magnetic Switch)

38MT Series

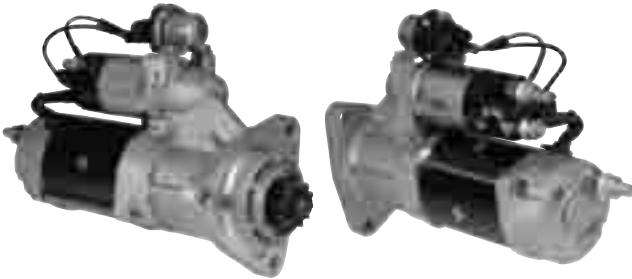

2-2372-DR

Starter - Delco 38MT Series
12 Volt, CW, 12-Tooth Pinion

Used On: Freightliner; Cummins ISC, ISL 8.3L; International DT466 7.6L
Replaces: Delco 8200005, 8300005, 19026029
Note: Solenoid positioned at 82°
Lester Nos: 6808
Features: 100% New w/ IMS (Integral Magnetic Switch)

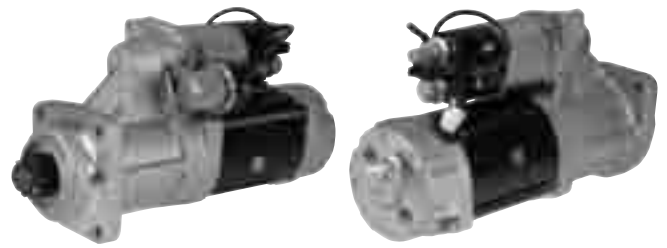

2-2379-DR

Starter - Delco 38MT Series
24 Volt, CW, 10-Tooth Pinion

Used On: Cummins ISB
Replaces: Delco 8200024, 8200078, 8300023, 19026032
Note: Solenoid positioned at 315°
Lester Nos: 6832
Features: 100% New w/ IMS (Integral Magnetic Switch)



2-2375-DR-1
(Ref# 6833N)

Starter - Delco 38MT Series
24 Volt, CW, 12-Tooth Pinion

Used On: Cummins ISC 8.3L
Replaces: Delco 8200000, 072; 8300025; 19026026, 030
Lester Nos: 6833
Note: Solenoid positioned at 82°
Features: 100% New w/ IMS (Integral Magnetic Switch)

2-2375-DR

Starter - Delco 38MT Series

Note: Same as 2-2375-DR-1 except mfd. by OE supplier w/ IMS (Integral Magnetic Switch)

39MT Series



2-2001-DR
(Ref# 6801N)

Starter - Delco 39MT Series
12 Volt, CW, 11-Tooth Pinion

Used On: Mack Truck, Mercedes-Benz Truck
Replaces: Delco 19011500
Lester Nos: 6801
Note: Solenoid positioned at 52°
Features: 100% New

HEAVY DUTY & OFF ROAD

HEAVY DUTY & OFF ROAD

DELCO - STARTERS

39MT Series (cont'd)



2-2345-DR-1
(Ref# 6819N)

Starter - Delco 39MT Series
24 Volt, CW, 11-Tooth Pinion

Used On: Cummins ISM 11.0L, ISX 15.0L
Replaces: Delco 8200041, 19011507, 19011522
Lester Nos: 6819
Note: Solenoid positioned at 82°
Features: 100% New w/ IMS (Integral Magnetic Switch)



2-2347-DR-1
(Ref# 11516N)

Starter - Delco 39MT Series
12 Volt, CW, 11-Tooth Pinion

Used On: Cummins ISX 15.0L, Freightliner, International, Volvo Truck
Replaces: Delco 8200033, 8200040, 10461753, 10461777, 19011506, 19011516, 19011518
Lester Nos: 6804, 6806
Note: Solenoid positioned at 82°
Features: 100% New w/ IMS (Integral Magnetic Switch)



2-2348-DR
Starter - Delco 39MT Series
24 Volt, CW, 11-Tooth Pinion

Used On: Cummins ISM 11.0L, ISX 15.0L
Replaces: Delco 8300016, 032, 039; 10461756; 19011509, 523
Lester Nos: 6852, 6853
Note: Solenoid positioned at 278°
Features: 100% New w/ IMS (Integral Magnetic Switch)



2-2349-DR-1
(Ref# 11524N)

Starter - Delco 39MT Series
24 Volt, CW, 12-Tooth Pinion

Used On: Cummins ISC 8.3L
Replaces: Delco 8200029, 043; 10461758; 19011511, 524
Lester Nos: 6803, 6813
Note: Solenoid positioned at 308°
Features: 100% New



2-2349-DR

Starter - Delco 39MT Series

Note: Same as 2-2349-DR-1 except mfd. by OE supplier w/ IMS (Integral Magnetic Switch)



2-2350-DR-2
(Ref# 6802N)

Starter - Delco 39MT Series
12 Volt, CW, 11-Tooth Pinion

Used On: Mack E7 12.0L
Replaces: Delco 8300020, 037; 10461334; 19011505, 531
Lester Nos: 6802, 6812
Note: Solenoid positioned at 52° Does not include IMS switch.
Features: 100% New



2-2350-DR

Starter - Delco 39MT Series

Note: Same as 2-2350-DR-2 except mfd. by OE supplier w/ IMS (Integral Magnetic Switch)



2-2352-DR-1

(Ref# 11518N)

Starter - Delco 39MT Series

12 Volt, CW, 11-Tooth Pinion

Used On: Cummins ISX 15.0L, Freightliner, International, Volvo Truck

Replaces: Delco 8200033, 040; 10461753; 19011506, 518

Lester Nos: 6804

Note: Solenoid positioned at 82° Does not include IMS switch.

Features: 100% New



2-2353-DR-1

(Ref# 11514N)

Starter - Delco 39MT Series

12 Volt, CW, 12-Tooth Pinion

Used On: Freightliner MBE 4000 12.8L

Replaces: Delco 10461773, 19011514

Lester Nos: 6818

Note: Solenoid positioned at 82°

Features: 100% New

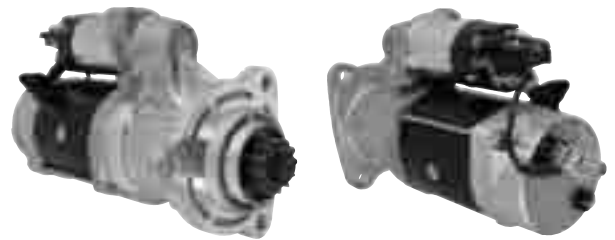

2-2364-DR

(Ref# 6826N)

Starter - Delco 39MT Series

24 Volt, CW, 12-Tooth Pinion

Used On: Cummins ISC 8.3L Engine

Replaces: Delco 8200027, 8200044, 19011512

Lester Nos: 6826

Note: Solenoid positioned at 82°

Features: 100% New



2-2366-DR

Starter - Delco 39MT Series

12 Volt, CW, 11-Tooth Pinion

Used On: Cummins ISX 15.0L, Freightliner, International, Volvo Truck

Replaces: Delco 19011530

Note: Solenoid positioned at 82°

Features: 100% New w/ IMS (Integral Magnetic Switch)



2-2367-DR

Starter - Delco 39MT Series

12 Volt, CW, 11-Tooth Pinion, OCP Thermostat

Used On: Caterpillar C15, Cummins ISX 15.0L, Detroit Diesel S60, Freightliner

Replaces: Delco 19011521

Note: Solenoid positioned at 82°

Features: 100% New w/ IMS (Integral Magnetic Switch) & OCP (Overcrank protection)

DELCO - STARTERS

39MT Series (cont'd)

photo not available

2-2822-DR
Starter - Delco 39MT Series
24 Volt, CW, 11-Tooth Pinion

Used On: Mercedes-Benz Truck
Replaces: Delco 19011501; Mercedes 004-151-50-01, 005-151-50-01, 005-151-64-01
Features: 100% New

photo not available

2-2823-DR
Starter - Delco 39MT Series
12 Volt, CW

Used On: Mercedes-Benz Truck
Replaces: Delco 19011504; Mercedes 005-151-10-01, 005-151-70-01
Features: 100% New

40MT, 42MT FEATURES

- 100% New
- Available with Zen Maxitork Drive
- Armature with heat treated shaft and welded steel-core riserless commutator
- Varnish dipped field coils
- Ductile iron D.E. housing
- Solenoids are 100% tested for coil strength, voltage drop across contacts and 'reserve burnoff' on the contacts
- Painted gloss black with zinc plated hardware
- 100% computerized load tested

40MT Series



2-2899-DR
 (Ref# 3096ML)
Starter - Delco 40MT Series
12 Volt, CCW, 11-Tooth Pinion

Replaces: Delco 1114059, 1114063, 1114080, 1114097, 1114106, 1114702, 1114808, 1114930, 1990212
Lester Nos: 3290
Features: 100% New

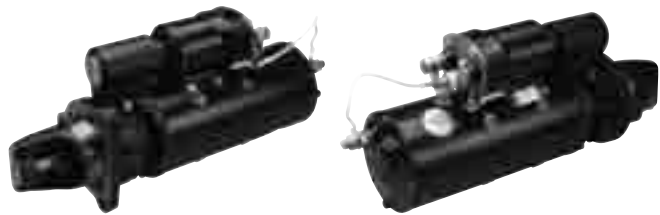

50-100-2
 (Ref# 3339N, 6606M)
Starter - Delco 40MT Series
12 Volt, CW, 12-Tooth Pinion

Replaces: Bosch 0-001-421-004; Caterpillar 3T2655; Cummins 3593752RX; Delco 1114109, 110, 114, 117, 127, 129, 136, 138, 141, 144, 149, 153, 156, 158, 162, 167, 169, 174, 175, 190, 199, 703, 705, 708, 714, 724, 734, 748, 753, 754, 823, 827, 828, 832, 834, 835, 882, 883, 885, 888, 911, 933, 967, 986, 1990221, 325; 1993703; Delco Reman. 10461046
Lester Nos: 3339
Note: Solenoid positioned at 82°
Features: 100% New

50-100-1
Starter - Delco 40MT Series

Note: Same as 50-100-2 except w/ Zen Maxitork Drive



50-103-2
 (Ref# 3094N, 3948N, 6607M)
Starter - Delco 40MT Series
24 Volt, CW, 12-Tooth Pinion

Replaces: Caterpillar 3R7356, 3Y8852, 5A6522, 5R3857; Delco 1113827, 840, 848, 853, 901, 904, 919, 922, 923, 925, 928, 930, 933, 934, 942, 943, 949, 950, 951, 959, 960, 962, 967, 969, 982, 987, 989, 990, 992, 993, 998; 1114706, 711, 712, 729, 735, 740, 742, 743, 759, 767, 772, 774, 777, 782, 793, 805, 843, 845, 856, 857, 858, 859, 860, 861, 862, 863, 864, 871, 872, 905, 910, 914, 917, 945, 949, 953, 968, 980, 989; 1990203, 204, 283, 297, 324, 343, 432; 1993704, 846 ;
 (cont'd)

(cont'd)

Delco Reman. 10461107; IHC 690644C92

Lester Nos: 3370, 3948

Note: Solenoid positioned at 278°

Features: 100% New



50-103-1

Starter - Delco 40MT Series

Note: Same as 50-103-2 except w/ Zen Maxitork Drive



50-104-2

Starter - Delco 40MT Series

24 Volt, CW, 11-Tooth Pinion

Replaces: Delco 1113905, 1114848 & others;

Delco Reman. 10461047

Lester Nos: 3745

Note: Solenoid positioned at 38°

Features: 100% New

50-104-1

(Ref# 3745N)

Starter - Delco 40MT Series

Note: Same as 50-104-2 except w/ Zen Maxitork Drive

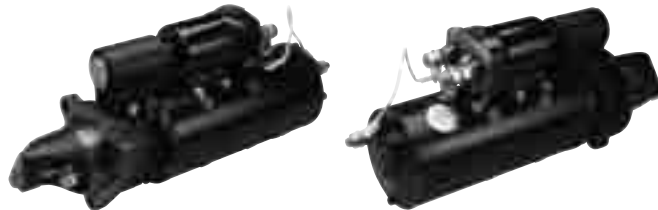

50-108-2

(Ref# 3974N, 3096M)

Starter - Delco 40MT Series

12 Volt, CW, 11-Tooth Pinion

Replaces: Cummins 3603863RX; Delco 1108830; 1109800, 807; 1113809; 1114004, 025, 051, 054, 055, 056, 058, 064, 067, 072, 073, 074, 076, 078, 081, 084, 086, 087, 088, 090, 091, 092, 095, 096, 098, 099, 102, 107, 113, 115, 118, 119, 122, 124, 126, 128, 130, 133, 140, 143, 145, 148, 150, 157, 164, 165, 170, 172, 179, 180, 185, 186, 187, 188, 189, 193, 194, 197, 720, 722, 723, 725, 726, 732, 741, 747, 749, 750, 751, 752, 761, 769, 788, 791, 795, 797, 798, 799, 800, 801, 803, 804, 806, 812, 813, 814, 815, 816, 819, 820, 889, 890, 891, 892, 893, 894, 895, 896, 897, 898, 899, 900, 901, 906, 912, 913, 928, 937, 938, 941, 943, 946, 956, 957, 961, 972, 975, 978, 983, 984, 985, 990, 993, 999; 1990201, 209, 296, 303, 306, 323; Delco Reman. 10461045

Lester Nos: 3974, 6243

Note: Solenoid positioned at 52°

Features: 100% New

(cont'd)

(cont'd)

50-108-1

(Ref# 3974N, 3096M)

Starter - Delco 40MT Series

Note: Same as 50-108-2 except w/ Zen Maxitork Drive

41MT Series



2-2472-DR

(Ref# 6630N)

Starter - Delco 41MT Series

12 Volt, CW, 12-Tooth Pinion

Used On: Freightliner, International, Sterling w/ Cummins 8.3L ISC Engines

Replaces: Cummins 3921402; Delco 10461240, 10478818, 10479109

Lester Nos: 6630

Features: 100% New

42MT Series



2-2471-DR

(Ref# 6516N)

Starter - Delco 42MT Series

12 Volt, CW, 12-Tooth Pinion

Used On: Caterpillar, Ford Trucks, Freightliner, Kenworth, Peterbilt, Volvo, Western Star, White

Replaces: Caterpillar 769132; Delco 1990349, 1990372, 1990397, 1993813, 1993856, 1993973, 10479041, 10479063, 10479064, 10479159; Ford E8HT-11001-AA; E8HZ-11002-A, -HA; F6HT-11001-BA, -FA; F6HZ-11002-BA, -FA

Lester Nos: 6516, 6566, 6769

Features: 100% New

HEAVY DUTY & OFF ROAD

HEAVY DUTY & OFF ROAD

DELCO - STARTERS

42MT Series (cont'd)

photo not available

2-2675-DR

(Ref# 6245N)

Starter - Delco 42MT Series
12 Volt, CW, 11-Tooth Pinion

Used On: Ford Trucks w/ Cummins L10, M11 Diesel Engines

Replaces: Delco 10478809; Ford F1HT-11001-AA, F1HZ-11002-A

Lester Nos: 6245

Features: 100% New



2-2703-DR

Starter - Delco 42MT Series
12 Volt, CW, 11-Tooth Pinion

Used On: Freightliner, Kenworth, Peterbilt, Sterling, Volvo Truck, Western Star w/ Caterpillar or Cummins Engines

Replaces: Caterpillar 3E7863; Cummins 3610942; Delco 1990490, 10461042, 10461053, 10479104

Lester Nos: 6511

Features: 100% New



50-150-2

(Ref# 6371N, 6806M)

Starter - Delco 42MT Series
12 Volt, CW, 12-Tooth Pinion

Replaces: Caterpillar 0R5218, 7N6503, 9L3597; Cummins 3603864RX, 3910645; Delco 1990353, 356, 362, 370, 379, 385, 387, 394, 399, 403, 404, 405, 425, 429, 441, 443, 452, 467, 469, 471, 480, 487, 492, 496; 1993772, 775, 783, 795, 806, 820, 935, 937, 938, 939, 942, 943, 961, 983; 10478803, 804, 835, 931, 934, 936, 992, 994, 10479004, 10479052, 10479117, 10479162, 10479191; Delco Reman. 10461021; IHC 430138C91, 673796C92

Lester Nos: 6371

Features: 100% New

50-150-1

(Ref# 6371N, 6806M)

Starter - Delco 42MT Series

Note: Same as 50-150-2 except w/ Zen Maxitork Drive



50-151-2

Starter - Delco 42MT Series
24 Volt, CW, 11-Tooth Pinion

Replaces: Delco 1990456, 1990485 & others; Delco Reman. 10461024

Lester Nos: 6370

Features: 100% New

50-151-1

Starter - Delco 42MT Series

Note: Same as 50-151-2 except w/ Zen Maxitork Drive



50-151-3

Starter - Delco 42MT Series
24 Volt, CW, 11-Tooth Pinion, OCP Thermostat

Replaces: Delco 1993788, 10461141

Lester Nos: 6552

Note: Will also replace starters wo/ overcrank protection (OCP): Delco 1990456, 485 & others (Lester 6370, WAI 50-151-1, -2)

Features: 100% New w/ OCP (Overcrank Protection)



50-152-2

(Ref# 6360N, 6807M)

Starter - Delco 42MT Series
24 Volt, CW, 12-Tooth Pinion

Replaces: Caterpillar 2S0900, 4N3182, 4N7905, 9M1662; Delco 1990357, 359, 433, 453, 457, 497; 1993797, 804, 809, 814, 833, 929; Delco Reman. 10461025

Lester Nos: 6360

Features: 100% New

50-152-1

(Ref# 6369N)

Starter - Delco 42MT Series

Note: Same as 50-152-2 except w/ Zen Maxitork Drive



50-153-2

(Ref# 6356N, 6800M)

Starter - Delco 42MT Series
12 Volt, CW, 11-Tooth Pinion

Replaces: Caterpillar 2N2761, 8L8206, PR5347, PR5348; Cummins 3021034; Delco 1990337, 348, 352, 354, 358, 363, 375, 376, 386, 392, 396, 398, 400, 420, 423, 424, 458, 465, 468, 470, 475, 477, 478, 483, 495; 1993803, 807, 816, 823, 975, 985; 10478810, 963; 10479037, 065, 072, 081, 110, 112, 113, 150, 185, 277; Delco Reman. 10461038; IHC 263819C91, 510275C91

Lester Nos: 6356

Note: Solenoid positioned at 52°
 For version w/ OCP thermostat use 50-192-2.

Features: 100% New

50-153-1

Starter - Delco 42MT Series

Note: Same as 50-153-2 except w/ Zen Maxitork Drive



50-192-2

Starter - Delco 42MT Series

12 Volt, CW, 11-Tooth Pinion, OCP Thermostat

Replaces: Delco 1990428 & others; Delco Reman. 10461028

Lester Nos: 6513

Note: Solenoid positioned at 52°

Features: 100% New w/ OCP (Overcrank Protection)

50-192-1

Starter - Delco 42MT Series

Note: Same as 50-192-2 except w/ Zen Maxitork Drive

50MT Series

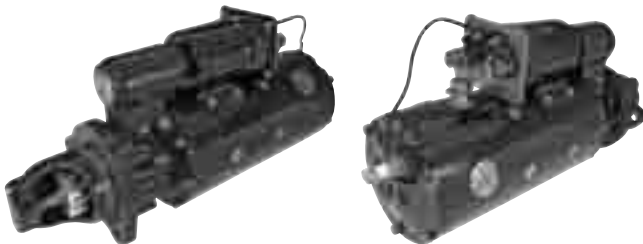

2-2473-DR

(Ref# 3905N)

Starter - Delco 50MT Series
12 Volt, CW, 11-Tooth Pinion

Replaces: Cummins 3604680RX; Delco 1109295, 1109545, 1109554, 1109790, 1990261, 1990277, 10461056

Lester Nos: 3905

Features: 100% New



2-2474-DR

(Ref# 4897N)

Starter - Delco 50MT Series
24 Volt, CW, 11-Tooth Pinion

Replaces: Caterpillar 3T8959, 9L2200, 9L5417; Cummins 3603866RX; Delco 1109635, 1109794, 1109832, 1109989, 1990241, 10478853

Lester Nos: 4897

Features: 100% New



50-111

(Ref# 4930N)

Starter - Delco 50MT Series
24 Volt, CW, 11-Tooth Pinion

Replaces: Delco 1109222, 285, 286, 287, 288, 289, 290, 291, 292, 293, 296, 298, 494, 553, 631, 636, 638, 642, 643, 647, 649, 755, 759, 768, 771, 772, 774, 775, 776, 777, 778, 780, 782, 787, 791, 838, 839, 840, 841, 842, 843, 845, 846, 961, 965, 972, 973, 977, 978, 979, 986, 987; 1990229, 231, 235, 237, 239, 248, 249, 250, 251, 259, 260, 262, 263, 264, 268, 269, 270, 271, 273, 274, 276

Lester Nos: 4930

Note: Solenoid positioned at 38°

Features: 100% New

50-111-1

Starter - Delco 50MT Series

Note: Same as 50-111 except w/ Zen Maxitork Drive

6V Early DD (Direct Drive)



2-2286-DR

(Ref# 4132N)

Starter - Delco DD
6 Volt, CCW, 10-Tooth Pinion

Used On: International Farmall Farm Tractors

Replaces: Case 63608D; Delco 1107427, 1107448; IHC 104219A2, 997870R91

Lester Nos: 4132

Features: 100% New

HEAVY DUTY & OFF ROAD

HEAVY DUTY & OFF ROAD

DELCO - STARTERS

6V Early DD (Direct Drive) (cont'd)



2-2287-DR
(Ref# 4033N)

Starter - Delco DD
6 Volt, CCW, 10-Tooth Pinion

Used On: International Farmall Farm Tractors
Replaces: Case 355794R91, 355794R92, A449934Z;
Delco 1107067, 1107093; IHC 104221A2
Lester Nos: 4033
Features: 100% New

PG260D Series



2-2336-DR
(Ref# 6494N)

Starter - Delco PG260D Series
1.2kW/12 Volt, CW, 9-Tooth Pinion

Used On: (2006-03) Chevrolet Avalanche 5.3L
(2006-04) Chevrolet Express, GMC Savana 4.8L, 5.3L
(2006-03) Chevrolet Silverado, GMC Sierra 4.8L, 5.3L
(2006-03) Chevrolet Suburban 5.3L
(2006-03) Chevrolet Tahoe, GMC Yukon 4.8L, 5.3L
(2006-04) Chevrolet Trailblazer, GMC Envoy 5.3L
Replaces: Delco 8000045, 9000939, 12578050, 12592294
Lester Nos: 6494
Also Replaces: Delco PG260F2 Starters: 9000842, 12560672 (Lester 6488) with short inboard mtg. bolt, however 2-2336-DR will require the included 85-1507 M10 x 1.50 x 113mm inboard mtg. bolt.
Delco PG260G Starters: 9000873, 925 (WAI 2-2211-DR-2, Lester 6489).
Components: 1) 85-1507 Mtg. Bolt (M10 x 1.50 x 113mm)
Features: 100% New

PG260F2 Series



2-1954-DR-2

Starter - Delco PG260F2 Series
1.5kW/12 Volt, CW, 11-Tooth Pinion

Used On: (2000-99) Chevrolet Astro, Blazer 4.3L
(2000-99) Chevrolet & GMC G1500, G2500 4.3L
(2000-98) Chevrolet S, T Series 4.3L
(2000-99) GMC Jimmy, Safari, Sierra 4.3L
(2000-98) GMC Sonoma
Replaces: Delco 9000841, 9000858, 12563176, 12563828
Lester Nos: 6485
Note: For PG260G design use 2-2112-DR-2.
Features: 100% New



2-2054-DR-2
(Ref# 6488N)

Starter - Delco PG260F2 Series
1.5kW/12 Volt, CW, 11-Tooth Pinion

Used On: (2001-99) Chevrolet Silverado, GMC Sierra 4.8L, 5.3L
(2001-00) Chevrolet Suburban, GMC Yukon XL 5.3L
(2001-00) Chevrolet Tahoe, GMC Yukon 4.8L, 5.3L
Replaces: Delco 9000842*, 9000854, 12563908
Lester Nos: 6488, 6489
Note: *Will also replace Delco 9000842, 12560672 (Lester 6488) starter with short inboard mtg. bolt, however 2-2054-DR-2 will require the included 85-1507 M10 x 1.50 x 113mm inboard mtg. bolt.
For PG260G design use 2-2211-DR-2.
For PG260D design use 2-2336-DR.
Components: 1) 85-1507 Mtg. Bolt (M10 x 1.50 x 113mm)
Features: 100% New

PG260G Series



2-2112-DR-2 (Ref# 6485N)

Starter - Delco PG260G Series 1.4kW/12 Volt, CW, 11-Tooth Pinion

Used On: (2004-01) Chevrolet Astro, GMC Safari 4.3L
(2004-01) Chevrolet Blazer, GMC Jimmy 4.3L
(2004-01) Chevrolet Express, GMC Savana 4.3L
(2004-01) Chevrolet S, T Series Pickup, GMC Sonoma 4.3L
(2004-01) Chevrolet Silverado, GMC Sierra 4.3L
(2001) Chevrolet Trailblazer, GMC Envoy 4.3L

Replaces: Delco 9000841, 858, 871, 910, 964, 973

Lester Nos: 6485

Also Replaces: Delco PG260F2 Starters: 9000841, 858
(WAI 2-1954-DR-2, Lester 6485).

Features: 100% New



2-2211-DR-2

Starter - Delco PG260G Series 1.4kW/12 Volt, CW, 11-Tooth Pinion

Used On: (2002) Chev. Avalanche, Suburban 5.3L
(2003) Chev. Express, GMC Savana 5.3L
(2002) Chev. Silverado, GMC Sierra 4.8L, 5.3L
(2002) Chev. Tahoe, GMC Yukon 4.8L, 5.3L
(2003) Chev. Trailblazer, GMC Envoy 5.3L

Replaces: Delco 9000873, 9000925, 12564111, 12573853;
Isuzu 8-10465-561-0,

Lester Nos: 6489

Also Replaces: Delco PG260F2 Starters: 9000842, 12560672
(Lester 6488) with short inboard mtg. bolt, however 2-2211-DR-2
will require the included 85-1507 M10 x 1.50 x 113mm inboard
mtg. bolt.

Delco PG260F2 Starters: 9000854 (WAI 2-2054-DR-2,
Lester 6489).

Note: For PG260D design use 2-2336-DR.

Components: 1) 85-1507 Mtg. Bolt (M10 x 1.50 x 113mm)

Features: 100% New

PG260L Series



2-2143-DR-2

Starter - Delco PG260L Series 1.6kW/12 Volt, CW, 11-Tooth Pinion

Used On: (2002) Chevrolet Avalanche; GMC Sierra, Yukon 8.1L
(2002) Chevrolet Express, GMC Savana 5.0L, 5.7L, 8.1L

Replaces: Delco 9000879, 12564108, 12570823

Lester Nos: 6449

Also Replaces: Delco PG260M starters: 9000786, 860, 899
(WAI 2-1690-DR-2, Lester 6449)

Features: 100% New

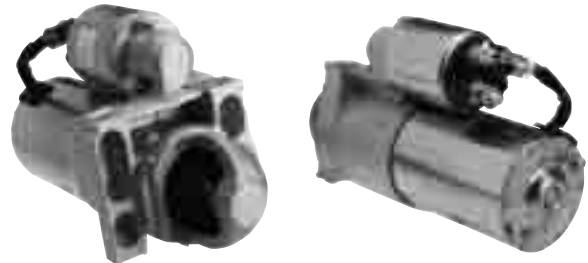

2-2200-DR-2

Starter - Delco PG260L Series 1.6kW/12 Volt, CW, 11-Tooth Pinion

Used On: (2005-03) Am General Hummer 6.0L
(2005-03) Chev. Express, GMC Savana 6.0L
(2005-01) Chev. Silverado, Suburban; GMC Sierra 6.0L
(2005) Chevrolet SSR 6.0L
(2005-01) GMC Yukon 6.0L

Replaces: Delco 8000052; 9000880, 927, 962; 12564110,
12573852, 12583115, 12592295,

Lester Nos: 6492

Also Replaces: Delco PG260M starter: 9000853
(WAI 2-2095-DR-2, Lester 6492)

Features: 100% New

DELCO - STARTERS

PG260M Series



2-1474-DR-2
(Ref# 6407N)

Starter - Delco PG260M Series
1.7kW/12 Volt, CW, 11-Tooth Pinion

Used On: (1990-88) Chevrolet Blazer, GMC Jimmy 4.3L
(1989-88) Chevrolet, GMC C, K Series Pickup 4.3L
(1989-88) Chevrolet, GMC S, T Series Pickup 4.3L
(1989) GMC Sierra 4.3L

Replaces: Delco 9000719, 735; 10465001, 009

Lester Nos: 6407

Note: 2-1474-DR-2 is a 1.7 kW, 11-tooth PG260M starter that replaces the earlier 1.4 kW, 9-tooth PG250 starter. Similar to 2-1690-DR-2 except 2-1474-DR-2 has solenoid battery term. clocked at 12:00.

Features: 100% New

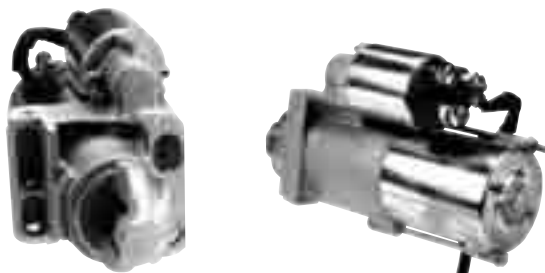

2-1690-DR-2
(Ref# 6449N)

Starter - Delco PG260M Series
1.7kW/12 Volt, CW, 11-Tooth Pinion

Used On: (1998-97) Chev. Astro, GMC Safari 4.3L
(1998-94) Chev. Blazer 4.3L, 5.7L
(2001-94) Chev. C, K Series; GMC Sierra 5.0L, 5.7L, 7.4L, 8.1L
(2001-94) Chev., GMC G Series 5.0L, 5.7L, 7.4L, 8.1L
(1999-94) Chev., GMC P Series Van 4.3L, 5.7L, 7.4L
(1998-96) Chev. S, T Series 4.3L; GMC Jimmy, Sonoma 4.3L
(2001-99) Chev. Silverado 6.0L, 8.1L
(2001-94) Chev. & GMC Suburban 5.7L, 7.4L, 8.1L
(2001-94) Chev. Tahoe, GMC Yukon 5.7L, 8.1L
GMC Topkick 7.0L

Replaces: Delco 9000786, 9000860, 9000899

Lester Nos: 6449

Note: For PG260L design use 2-2143-DR-2

Features: 100% New



2-1811-DR-2
(Ref# 6482N)

Starter - Delco PG260M Series
1.7kW/12 Volt, CW, 11-Tooth Pinion

Used On: (2001-00) Chevrolet Silverado, Suburban;
(2001-00) GMC Sierra, Yukon 6.0L

Replaces: Delco 9000834, 866

Lester Nos: 6482

Note: 2-1811-DR-2 has short inboard mtg. bolt and can be replaced with 2-2095-DR starter and 85-1507 long inboard mtg. bolt (M10 x 1.50 x 113mm).

Features: 100% New



2-1912-DR-2
(Ref# 6452N)

Starter - Delco PG260M Series
1.7kW/12 Volt, CW, 9-Tooth Pinion

Used On: (2000-96) Chev., GMC Medium Duty Trucks 6.0L,
7.0L, 7.4L

Replaces: Delco 9000812, 9000864

Lester Nos: 6452

Features: 100% New



2-2095-DR-2
(Ref# 6492N)

Starter - Delco PG260M Series
1.7kW/12 Volt, CW, 11-Tooth Pinion

Used On: (2001-00) Chevrolet Silverado, Suburban 6.0L
(2001-00) GMC Sierra, Yukon 6.0L

Replaces: Delco 9000853, 12563907

Lester Nos: 6492

Also Replaces: Delco 9000834 (Lester 6482, WAI 2-1811-DR) starter with short inboard mtg. bolt, however 2-2095-DR-2 will require the long 85-1507 M10 x 1.50 x 113mm inboard mtg. bolt.

Note: For PG260L design use 2-2200-DR-2.

Features: 100% New

SD200, SD250 (5MT) Series



2-1413-DR
(Ref# 6313N)

Starter - Delco SD200 (5MT) Series
12 Volt, CW, 9-Tooth Pinion

Used On: (1989-84) Chevrolet Blazer, GMC Jimmy 2.8L
(1985-84) Chevrolet Blazer, GMC Jimmy 5.0L
(1985-84) Chevrolet, GMC C, K Series Pickup 5.0L
(1993-84) Chevrolet, GMC S, T Series Pickup 2.8L
(1985-84) Chevrolet, GMC Suburban 5.0L

Replaces: Delco 1998427, 1998524, 10455016

Lester Nos: 6313

Features: 100% New



2-1493-DR
(Ref# 6330N)

Starter - Delco SD200 (5MT) Series
12 Volt, CW, 9-Tooth Pinion

Used On: (1988-85) Chevrolet Blazer 2.5L
(1993-90) Chevrolet Post Office Vehicle 2.5L
(1993-85) Chevrolet S, T Series Pickup 2.5L
(1988-85) GMC Jimmy 2.5L
(1989-85) GMC S, T Series Pickup 2.5L
(1993-90) GMC Sonoma 2.5L

Replaces: Delco 1998482, 1998532, 1998537, 10455018;
Hitachi S114-822

Lester Nos: 6330

Dim: 4.675" Field Case, 10mm Mtg.

Note: For Nippondenso replacement design use 2-1493-ND-2

Features: 100% New

SD205, SD255 Series

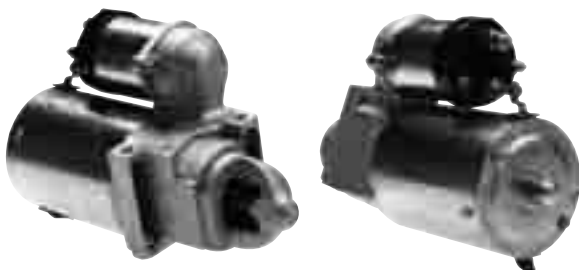

2-1796-DR
(Ref# 6483N)

Starter - Delco SD255 Series
12 Volt, CW, 9-Tooth Pinion

Used On: (1999-97) Chev. C, K Series; GMC Sierra 4.3L, 5.0L, 5.7L
(1999-97) Chev. Express, GMC Savana Vans 4.3L, 5.0L
(1999-98) Chevrolet, GMC Suburban 5.7L
(2000-98) Chevrolet Tahoe, GMC Yukon 5.7L

Replaces: Delco 10455065, GM 12558851

Lester Nos: 6483

Features: 100% New

SD260 Series

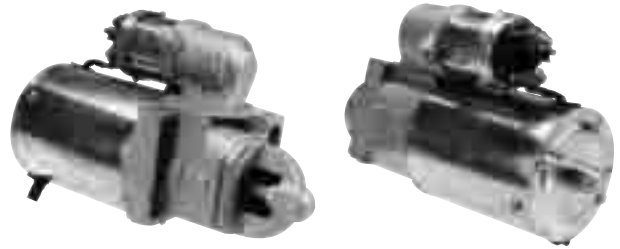

2-1470-DR
(Ref# 6416N)

Starter - Delco SD260 Series
12 Volt, CW, 9-Tooth Pinion

Used On: (1996-91) Chevrolet Astro, Blazer 4.3L
(1996-90) Chevrolet C, K Series Pickup 4.3L, 5.0L
(1996-91) Chevrolet, GMC G Series Van 4.3L, 5.0L
(1995-90) Chevrolet S, T Series Pickup 4.3L
(1996-91) GMC Jimmy, Safari 4.3L
(1996-90) GMC Sierra 4.3L, 5.0L
(1995-90) GMC Sonoma 4.3L

Replaces: Delco 10455013, 042, 050, 070

Lester Nos: 6416

Features: 100% New

SD300 (10MT) Series



2-1592-DR
(Ref# 3838N)

Starter - Delco SD300 (10MT) Series
12 Volt, CW, 9-Tooth Pinion, 3/8" Mtg.

Used On: (1984-83) Chevrolet, GMC 3.8L
(1992-84) Chevrolet, GMC 4.3L, 5.0L, 5.7L

Replaces: Delco 1988711, 1998557, 10455300, 10496871

Lester Nos: 3838

Note: For PG260M design use 2-1590-DR-2.

Features: 100% New

HEAVY DUTY & OFF ROAD

HEAVY DUTY & OFF ROAD

DELCO - STARTERS

SD300 (10MT) Series (cont'd)

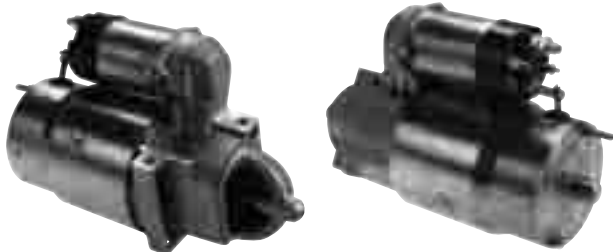

2-1593-DR

(Ref# 3510N)

Starter - Delco SD300 (10MT) Series
12 Volt, CW, 9-Tooth Pinion, 3/8" Mtg.

Used On: (1981-80) Chevrolet, GMC 5.0L (1983-70) Chevrolet, GMC 5.7L, 6.6L, 7.4L

Replaces: Delco 1998440

Lester Nos: 3510

Note: For PG260M design use 2-1593-DR-2.

Features: 100% New



2-1595-DR

Starter - Delco SD300 (10MT) Series
12 Volt, CW, 9-Tooth Pinion

Used On: (1974-73) Chev., GMC G Series Van 4.1, 5.0L w/ MT

Replaces: Delco 1107365; 1108338, 350, 382, 400, 418, 520, 775, 783, 788; 1109059

Lester Nos: 3560, 3627

Features: 100% New



2-1598-DR-2

(Ref# 4174N)

Starter - Delco SD300 (10MT) Series
12 Volt, CW, 9-Tooth Pinion

Used On: Chevrolet, GMC School Buses, Trucks

Replaces: Delco 1108753, 1109034, 1109075, 1998206, 1998228, 1998231, 1998250, 1998472, 1998501, 1998596

Lester Nos: 4174

Features: 100% New



2-1601-DR-2

(Ref# 3635N, 5312M)

Starter - Delco SD300 (10MT) Series
12 Volt, CW, 9-Tooth Pinion

Used On: (1977-76) Chev., GMC C, K Series Pickup 4.8L w/ MT (1977-73) Chev., GMC P Series Step Van 4.8L w/ MT (1974-73) Chev., GMC P Series Step Van 5.7L w/ MT (1977-76) Chev., GMC Suburban 4.8L w/ MT Chris Craft, Crusader Marine

Replaces: Delco 1107233, 1107273, 1107274, 1107315, 1107369, 1107497, 1107664, 1107688, 1107889, 1107891, 1108332, 1108355, 1108360, 1108368, 1108372, 1108486, 1108489, 1108784, 1108787, 1108793, 1109078, 1109099, 1998256, 1998275, 1998473, 1998592

Lester Nos: 3635

Features: 100% New

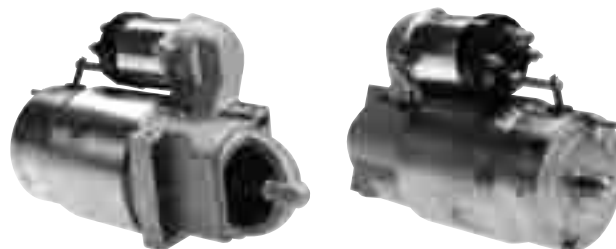

2-1604-DR

(Ref# 3510MN)

Starter - Delco SD300 (10MT) Series
12 Volt, CW, 9-Tooth Pinion, 10mm Mtg.

Used On: (1990-85) Chevrolet, GMC 4.3L

(1994-82) Chevrolet, GMC 5.0L, 5.7L, 7.4L

Replaces: Delco 1998584, 10455305, 10496873

Lester Nos: 3510M

Features: 100% New

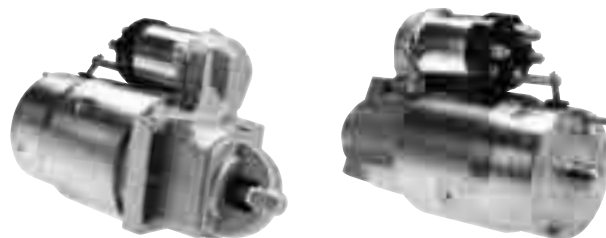

2-1607-DR

(Ref# 3733N)

Starter - Delco SD300 (10MT) Series
12 Volt, CW, 9-Tooth Pinion, 10mm Mtg.

Used On: (1984-82) Chevrolet, GMC Pickup 4.1L w/ AT

(1986-85) Chevrolet, GMC Pickup 4.3L w/ AT

(1988-82) Chevrolet, GMC Pickup 4.8L w/ AT

(1993-82) Chev., GMC Pickup, Suburban, SUV 5.0L, 5.7L, 7.4L w/ AT

Replaces: Delco 1998443, 10455306

Lester Nos: 3733

Features: 100% New



2-2596-DR-2

(Ref# 4234N)

**Starter - Delco SD300 (10MT) Series
12 Volt, CW, 9-Tooth Pinion**

Used On: Clark Lift Trucks, Minneapolis Moline, Teledyne, White Lift Trucks

Replaces: Clark 391632, 636180, 916303, 2355693, 2355694, 2377360; Delco 1107378, 1109091, 1998267, 12301277; Hyster 3001008, 3002935, 3004552; Towmotor 215861, 215987, 971561; Yale 2200023-97, 2200072-52, 2200073-59

Lester Nos: 4234

Features: 100% New



2-2753-DR-2

(Ref# 4525N)

**Starter - Delco SD300 (10MT) Series
12 Volt, CW, 10-Tooth Pinion**

Used On: Hyster Lift Trucks

Replaces: Delco 1108443, 1108493, 1109418, 1109439, 1998293; Hyster 2135890, 284074, 3001023, 3136101, 335867; Yale 2200071-43

Lester Nos: 4525

Note: For wet clutch applications.

Features: 100% New

ELECTROPRECIZIA - ALTERNATORS



20-9900

**Alternator - Electroprecizia ER/EF (Romanian)
36 Amp/12 Volt, 1-Groove Pulley**

Used On: Allis-Chalmers, Long Tractors

Replaces: Electroprecizia 1132

Lester Nos: 12170

Features: 100% New

ELECTROPRECIZIA - STARTERS



50-9900

**Starter - Electroprecizia DD (Romanian)
12 Volt, CW, 9-Tooth Pinion**

Used On: Allis-Chalmers, Long Tractor

Replaces: Electroprecizia DM2130, DM2134; Marelli 63217121, MT71Z

Lester Nos: 17184

Features: 100% New

FORD - ALTERNATORS

1G (ER/EF)

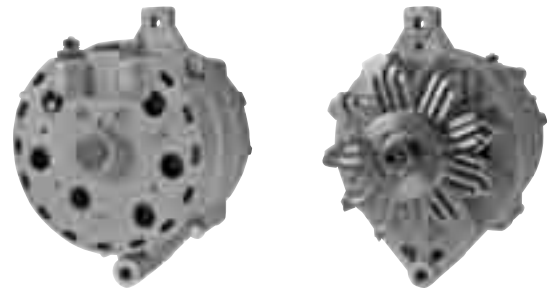

1-1806-12FD

(Ref# 7705N)

**Alternator - Ford 1G Series ER/EF
100 Amp/12 Volt, CW, 1-Groove Pulley**

Used On: (1985-79) Ford 5.0L, 5.8L, 7.5L

Replaces: Ford D8VF-10300-BA, D9BF-10300-AA, E1BF-10300-CA, E1VF-10300-AA

Lester Nos: 7705

Features: 100% New



20-202

(Ref# 7058N)

**Alternator - Ford 1G Series ER/EF
65 Amp/12 Volt, CW, 1-Groove Pulley**

Used On: (1975-80) Ford

Replaces: Ford D7AZ-10346-B, D7AZ-10346-C

Lester Nos: 7058, 7078, 7706

Features: 100% New

HEAVY DUTY & OFF ROAD

HEAVY DUTY & OFF ROAD

FORD - ALTERNATORS

1G (ER/EF) (cont'd)



20-209-9

**Alternator - Ford 1G Series Truck ER/EF
90 Amp/12 Volt, wo/ pulley or fan**

Used On: Ford Truck

Replaces: Ford D4HF-10346-BA, D4HZ-10346-B, GL-93-C, GL-94-C

Lester Nos: 7069

Note: Remanufactured



20-210-1

(Ref# 7712N)

**Alternator - Ford 1G Series Truck Blue Back ER/EF
90 Amp/12 Volt, wo/ pulley or fan**

Used On: Ford Truck

Replaces: Ford E2HF-10346-AA; E2HF-10346-BA, -CA, -DA; E2HZ-10346-B, -C, -D, -E; E7PF-10346-AAA, E8PZ-10346-AA; FOHU-10346-AA, -BA, -CA, -DA, -EA, -FA; FOHZ-10346-A, -B, -C, -D, -E, -F

Lester Nos: 7711, 7712

Features: 100% New

2G (IR/EF)



20-207-31-2

(Ref# 7732N)

Alternator - Ford 2G Series IR/EF

75A/12V, CW, 6-Groove Pulley, 10:00 Plug Clock

Used On: (1986) Ford Aerostar 2.8L

(cont'd)

(cont'd)

(1992-86) Ford Ranger 2.9L

Replaces: Ford E6DF-10300-BA, -EA, -EB; E6DZ-10346-C, E7PZ-10346-D

Lester Nos: 7732

Note: Also replaces Lester 7084, 7088, 7731

Features: 100% New



20-216-10

(Ref# 7735N)

Alternator - Ford 2G Series IR/EF

80 Amp/12 Volt, CW, wo/ pulley, 2:00 Plug Clock

Used On: (1987-86) Ford Aerostar 2.3L

(1991-87) Ford Aerostar 3.0L

(1989-86) Ford Bronco II, Ranger 2.9L

(1990) Ford E Series Van 5.0L, 5.8L, 7.5L

(1992-91) Ford F Series Pickup 5.0L, 5.8L, 7.5L

(1991-85) Ford Ranger 2.0L, 2.3L

Replaces: Ford E9PZ-10346-B

Lester Nos: 7745

Note: Also replaces Lester 7716, 7735, 7738

Features: 100% New



20-216-30

Alternator - Ford 2G Series IR/EF

80 Amp/12 Volt, CW, wo/ pulley, 10:00 Plug Clock

Used On: (1991-87) Ford Aerostar 3.0L

(1989-86) Ford Bronco 4.9L

(1992-86) Ford Bronco 5.0L, 5.8L

(1989-86) Ford E Series Van, F Series Pickup 4.9L

(1992-86) Ford E Series Van, F Series Pickup 5.0L

(1992-86) Ford E Series Van, F Series Pickup 5.8L

(1987-86) Ford E Series Van, F Series Pickup 6.9L

(1989-88) Ford E Series Van, F Series Pickup 7.3L

(1994-86) Ford E Series Van, F Series Pickup 7.5L

(1991) Ford Ranger 3.0L

Replaces: Ford E9PZ-10346-A

Lester Nos: 7716, 7735

Features: 100% New



20-208-30-1

Alternator - Ford 2G Series IR/EF
80 Amp/12 Volt, CW, w/ Integral BBS Pigtail Leads,
wo/ pulley, 10:00 Plug Clock

Note: Same as 20-216-30 except w/ Transpo rectifier featuring integral BBS pigtail leads to replace the OE spade terminal plug connector

Features: 100% New
 50A, 13mm press-fit diodes with crimp-weld terminations
 Makes a solid connection to avoid the burn-up problems associated with the spade terminal plug connector on Ford 2G alternators.



20-220-30

Alternator - Ford 2G Series IR/EF
80 Amp/12 Volt, CW, wo/ pulley, 10:00 Plug Clock

Used On: (1986) Ford Aerostar 2.8L
 (1992-86) Ford Ranger 2.9L

Replaces: Ford E9PZ-10346-D

Lester Nos: 7744

Note: Also replaces Lester 7084, 7088, 7731, 7732

Features: 100% New



20-219-10

(Ref# 7746N)

Alternator - Ford 2G Series IR/EF
80 Amp/12 Volt, CW, wo/ pulley, 02:00 Plug Clock

Used On: (1991-90) Ford Aerostar, Ranger 4.0L

Replaces: Ford F0PZ-10346-A, -B

Lester Nos: 7746

Features: 100% New

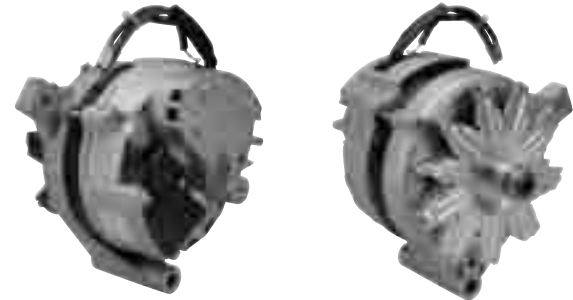

20-207-30-1

Alternator - Ford 2G Series IR/EF
80 Amp/12 Volt, CW, w/ Integral BBS Pigtail Leads,
wo/ pulley, 10:00 Plug Clock

Note: Same as 20-220-30 except w/ Transpo rectifier featuring integral BBS pigtail leads to replace the OE spade terminal plug connector

Features: 100% New

50A, 13mm press-fit diodes with crimp-weld terminations
 Makes a solid connection to avoid the burn-up problems associated with the spade terminal plug connector on Ford 2G alternators.



20-220-10

(Ref# 7744N)

Alternator - Ford 2G Series IR/EF
80 Amp/12 Volt, CW, wo/ pulley, 02:00 Plug Clock

Used On: (1992-87) Ford Bronco 4.9L

(1989-87) Ford Bronco 5.0L, 5.8L

(1990-87) Ford Bronco II 2.9L

(1994-87) Ford F Series Pickup 4.9L

Replaces: Ford E9PZ-10346-C

Lester Nos: 7744

Note: Also replaces Lester 7084, 7088, 7732

Features: 100% New

FORD - ALTERNATORS

3G (IR/IF)



1-1612-33FD-2
(Ref# 7764N)

Alternator - Ford 3G Series IR/IF

130A/12V, CW, 8-Groove Pulley, 10:00 Plug Clock

Used On: (2001-00) Ford Excursion, F Series Pickup 5.4L, 6.8L

Replaces: Ford F65U-10300-BB

Lester Nos: 7764

Components: 24-2266 Pulley

F794 (35-204) I-S-A Regulator

Features: 100% New



1-1997-11FD-2
(Ref# 7785N)

Alternator - Ford 3G Series IR/IF

95A/12V, CW, 8-Groove Pulley, 2:30 Plug Clock

Used On: (1992-95) Ford Truck B, F Series 5.9L, 8.3L (FD1060, FD1460 Engines)

Replaces: Ford F5PZ-10346-GA

Lester Nos: 7749, 7758, 7785

Note: 10-3032-4 wide D.E. bearing.

Replaces Ford F3HT-10300-GB with smaller 6-303-4 D.E. bearing.

Components: 24-2265 Pulley

F794 (35-204) I-S-A Regulator

Features: 100% New



20-221-10-2

Alternator - Ford 3G Series IR/IF

95 Amp/12 Volt, CW, wo/ pulley, 2:30 Plug Clock

Used On: (1997-95) Ford Aerostar 3.0L

(1997-92) Ford Aerostar 4.0L

(cont'd)

(cont'd)

(1996-93) Ford Bronco 5.0L, 5.8L

(2003-97) Ford E Series Van 4.2L

(1996-93) Ford E Series Van 5.0L, 5.8L

(2001-97) Ford F Series Pickup 4.2L

(1997-93) Ford F Series Pickup 5.0L, 5.8L

(1997-92) Ford Ranger 2.3L

(2002-98) Ford Ranger 2.5L

(2005-96) Ford Ranger 3.0L

(2001-92) Ford Ranger 4.0L w/ MT

Replaces: Ford F6PZ-10346-LA

Lester Nos: 7750

Components: F794 (35-204) I-S-A Regulator

Features: 100% New

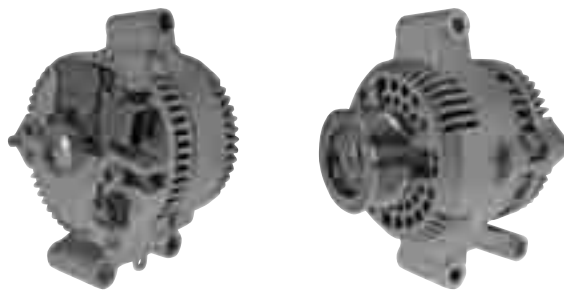

20-221-11-2
(Ref# 7750N)

Alternator - Ford 3G Series IR/IF

**95A/12V, CW, 6-Groove/66mm OD Pulley,
2:30 Plug Clock**

Used On: (1993-92) Ford Aerostar 4.0L

(1996-93) Ford Bronco 5.0L, 5.8L

(1996-93) Ford E Series Van 5.0L, 5.8L

(1994-91) Ford Explorer 4.0L

(1997-93) Ford F Series Pickup 5.0L, 5.8L

(1997-92) Ford Ranger 2.3L, 3.0L, 4.0L

Replaces: Ford F07F-10300-AA; F07U-10300-AA, -AB, -AC;

F17U-10300-AA, F67U-10300-AA

Lester Nos: 7750

Components: 24-2257 Pulley

F794 (35-204) I-S-A Regulator

Features: 100% New



20-221-12-2

Alternator - Ford 3G Series IR/IF

**95A/12V, CW, 6-Groove/57mm OD Pulley,
2:30 Plug Clock**

Used On: (1997-94) Ford Aerostar 3.0L, 4.0L

(1996) Ford Bronco 5.0L, 5.8L

(2003-97) Ford E Series Van 4.2L

(2001-97) Ford F Series Pickup 4.2L

(2001-98) Ford Ranger 2.5L

(2005-98) Ford Ranger, 3.0L

(2001-96) Ford Ranger 4.0L w/ MT

Replaces: Ford F57U-10300-AA, F67U-10300-BA

(cont'd)

(cont'd)

Lester Nos: 7750

Components: 24-2254 Pulley
F794 (35-204) I-S-A Regulator

Features: 100% New



20-225-11-2

Alternator - Ford 3G Series IR/IF

95A/12V, CW, 6-Groove Pulley, 2:30 Plug Clock

Used On: (1996-92) Ford E Series Van 4.9L
(1996-95) Ford F Series Pickup 4.9L

Replaces: Ford F2UU-10300-EA

Lester Nos: 7755

Components: 24-2254 Pulley
F794 (35-204) I-S-A Regulator

Features: 100% New



20-226-10-2

(Ref# 7756N)

Alternator - Ford 3G Series IR/IF

130 Amp/12 Volt, CW, wo/ pulley, 2:30 Plug Clock

Used On: (1996-92) Ford E Series Van 4.9L, 7.5L
(1992) Ford E Series Van 5.0L, 5.8L, 7.3L
(1997-94) Ford F Series Pickup 4.9L, 7.5L

Replaces: Ford F2UZ-10346-B, F6PZ-10346-XA

Lester Nos: 7756

Components: F794 (35-204) I-S-A Regulator

Features: 100% New

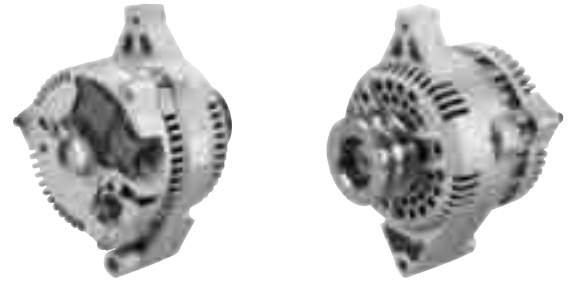

20-226-11-2

Alternator - Ford 3G Series IR/IF

130A/12V, CW, 2-Groove Pulley, 2:30 Plug Clock

Used On: (1992) Ford E Series Van 7.3L

Replaces: Ford F2UU-10300-DC

Lester Nos: 7756

Components: 24-2105 Pulley
F794 (35-204) I-S-A Regulator

Features: 100% New



20-226-12-2

Alternator - Ford 3G Series IR/IF

130A/12V, CW, 6-Groove/66mm OD Pulley, 2:30 Plug Clock

Used On: (1992) Ford E Series Van 5.0L, 5.8L

(1995-92) Ford E Series Van 7.5L

(1995) Ford F Series Pickup 7.5L

Replaces: Ford F2UU-10300-BE

Lester Nos: 7756

Components: 24-2257 Pulley
F794 (35-204) I-S-A Regulator

Features: 100% New

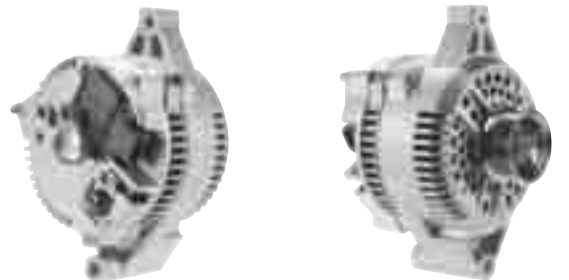

20-226-13-2

Alternator - Ford 3G Series IR/IF

130A/12V, CW, 6-Groove/57mm OD Pulley, 2:30 Plug Clock

Used On: (1996-92) Ford E Series Van 4.9L

(1996) Ford E Series Van 7.5L

(1996-94) Ford F Series Pickup 4.9L

(1997-96) Ford F Series Pickup 7.5L

Replaces: Ford F2UU-10300-FA

Lester Nos: 7756

Components: 24-2254 Pulley
F794 (35-204) I-S-A Regulator

Features: 100% New

FORD - ALTERNATORS

3G (IR/IF) (cont'd)

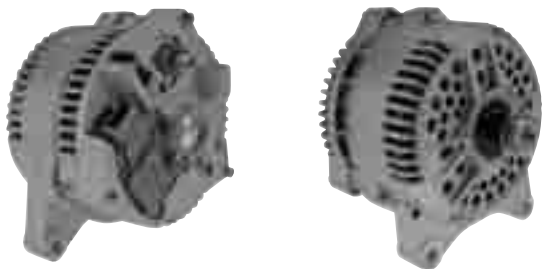

20-227-30-2

Alternator - Ford 3G Series IR/IF

130 Amp/12 Volt, CW, wo/ pulley, 10:00 Plug Clock

Used On: (2006-02) Ford E Series Van 4.6L, 5.4L

Replaces: Ford F6AZ-10346-AA

Lester Nos: 7764

Components: F794 (35-204) I-S-A Regulator

Features: 100% New



20-228-10-2

Alternator - Ford 3G Series IR/IF

130 Amp/12 Volt, CW, wo/ Pulley, 2:30 Plug Clock

Used On: (2002-97) Ford E Series Van 4.2L

(1996-93) Ford E Series Van 5.0L, 5.8L

(2002-92) Ford E Series Van 7.3L

(2002-97) Ford F Series Pickup 4.2L

(1997-92) Ford F Series Pickup 7.3L

(2001-96) Ford Ranger 4.0L w/ AT

Replaces: Ford F6UZ-10346-VA

Lester Nos: 7768

Components: F794 (35-204) I-S-A Regulator

Features: 100% New

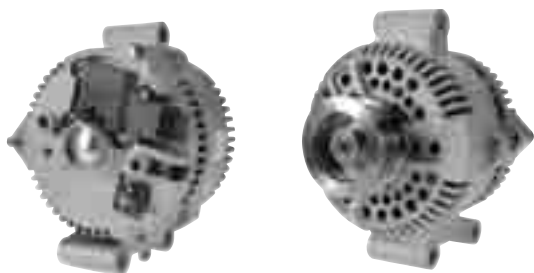

20-228-11-2

Alternator - Ford 3G Series IR/IF

**130A/12V, CW, 6-Groove/66mm OD Pulley,
2:30 Plug Clock**

Used On: (1996-93) Ford E Series Van 5.0L, 5.8L

(2001-92) Ford E Series Van 7.3L

(cont'd)

(cont'd)

(1994-93) Ford Explorer 4.0L

(1995-92) Ford F Series Pickup 7.3L

Replaces: Ford F37U-10300-AA; F3UU-10300-AE, -AF;
F6UU-10300-CA

Lester Nos: 7768

Components: 24-2257 Pulley

F794 (35-204) I-S-A Regulator

Features: 100% New



20-228-12-2

Alternator - Ford 3G Series IR/IF

**130A/12V, CW, 6-Groove/57mm OD Pulley,
2:30 Plug Clock**

Used On: (2004-97) Ford E Series Van, F Series Pickup 4.2L

(2001-95) Ford Explorer 4.0L

(2001-96) Ford Ranger 4.0L w/ AT

Replaces: Ford F2TU-10300-AF, F6UU-10300-FA

Lester Nos: 7768

Components: 24-2254 Pulley

F794 (35-204) I-S-A Regulator

Features: 100% New

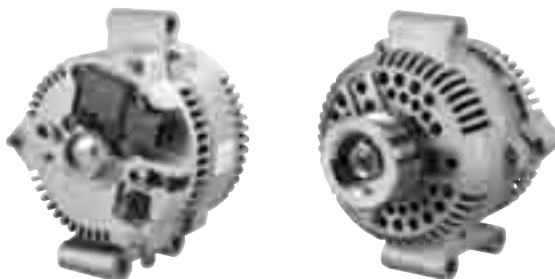

20-228-13-2

Alternator - Ford 3G Series IR/IF

130A/12V, CW, 7-Groove Pulley, 2:30 Plug Clock

Used On: (1994) Ford F Series Pickup 7.3L

Replaces: Ford F5UU-10300-AA

Lester Nos: 7768

Components: 24-2262 Pulley

F794 (35-204) I-S-A Regulator

Features: 100% New



20-228-14-2
(Ref# 7768N)

Alternator - Ford 3G Series IR/IF
130A/12V, CW, 8-Groove Pulley, 2:30 Plug Clock

Used On: (2003-95) Ford E Series Van 7.3L
(1997-95) Ford F Series Pickup 7.3L
Replaces: Ford F5UU-10300-BA, F6UU-10300-EA
Lester Nos: 7768
Components: 24-2261-1 Pulley
F794 (35-204) I-S-A Regulator
Features: 100% New



20-229-12-2

Alternator - Ford 3G Series IR/IF
95A/12V, CW, 6-Groove/57mm OD Pulley,
2:30 Plug Clock

Used On: (1994-92) Ford Aerostar 3.0L
(1997-96) Ford F Series Pickup 7.5L
Replaces: Ford F1SU-10300-BA, F29U-10300-AB
Lester Nos: 7749, 7758
Components: 24-2254 Pulley
F794 (35-204) I-S-A Regulator
Features: 100% New



20-229-10-2

Alternator - Ford 3G Series IR/IF
95 Amp/12 Volt, CW, wo/ pulley, 2:30 Plug Clock

Used On: (1994-92) Ford Aerostar 3.0L
(1992) Ford E Series Van 5.0L, 5.8L
(1996-92) Ford E Series Van 7.5L
(1997-95) Ford F Series Pickup 7.5L
(1993) Ford Truck B, F Series Truck 5.9L, 7.0L, 8.3L
Replaces: Ford F6PZ-10346-KA
Lester Nos: 7749, 7758
Components: F794 (35-204) I-S-A Regulator
Features: 100% New



20-229-14-2

Alternator - Ford 3G Series IR/IF
95A/12V, CW, 6-Groove/66mm OD Pulley,
2:30 Plug Clock

Used On: (1992) Ford E Series Van 5.0L, 5.8L
(1996-92) Ford E Series Van 7.5L
(1995) Ford F Series Pickup 7.5L
Replaces: Ford F2UU-10300-CD
Lester Nos: 7749, 7758
Components: 24-2257 Pulley
F794 (35-204) I-S-A Regulator
Features: 100% New



20-229-11-2

Alternator - Ford 3G Series IR/IF
95A/12V, CW, 2-Groove Pulley, 2:30 Plug Clock

Used On: (1994-93) Ford F Series Truck 7.0L
Replaces: Ford F1HT-10300-AA, -AB, -AC
Lester Nos: 7749, 7758
Components: 24-2106 Pulley
F794 (35-204) I-S-A Regulator
Features: 100% New

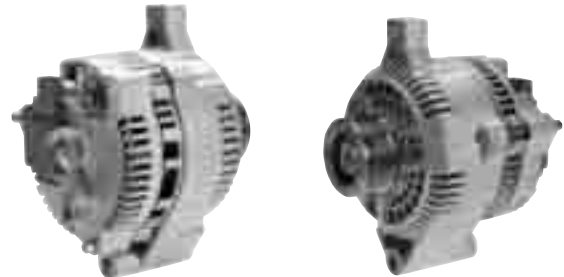

20-229-31-2

(Ref# 7749N)

Alternator - Ford 3G Series IR/IF
95A/12V, CW, 6-Groove Pulley, 11:00 Plug Clock

Used On: (1995) Ford F Series Truck 7.0L
Replaces: Ford FOVF-10300-AA; FOVU-10300-AA, -AB, -AC;
F5HT-10300-AA
Lester Nos: 7749, 7758
Components: 24-2254 Pulley
F794 (35-204) I-S-A Regulator
Features: 100% New

HEAVY DUTY & OFF ROAD

HEAVY DUTY & OFF ROAD

FORD - ALTERNATORS

3G (IR/IF) (cont'd)



20-232-10-2

**Alternator - Ford 3G Series IR/IF
115A/12V, CW, wo/ pulley, 2:30 Plug Clock**

Used On: (1993) Ford Heavy Duty Truck B, F Series
Replaces: Ford F3HZ-10346-B
Lester Nos: 7778
Components: F794 (35-204) I-S-A Regulator
Features: 100% New



20-232-11-2

(Ref# 7778N)

**Alternator - Ford 3G Series IR/IF
115A/12V, CW, 2-Groove Pulley, 2:30 Plug Clock**

Used On: (1994-93) Ford F Series Truck 7.0L
Replaces: Ford F3HT-10300-LA
Lester Nos: 7778
Components: 24-2106 Pulley
F794 (35-204) I-S-A Regulator
Features: 100% New

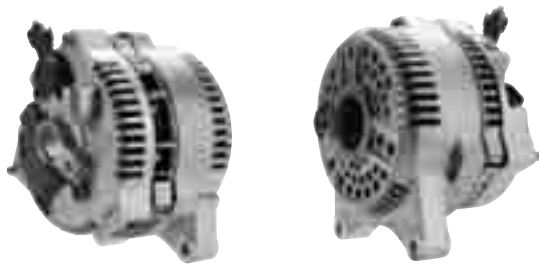

20-239-30-2

**Alternator - Ford 3G Series IR/IF
130A/12V CW, wo/ pulley, 10:00 Plug Clock**

Used On: (2006-97) Ford E Series Van 4.6L, 5.4L, 6.8L
(2002-97) Ford Expedition 4.6L, 5.4L
(2003-97) Ford F Series Pickup 4.6L, 5.4L
Replaces: Ford F6PZ-10346-B, F6PZ-10346-EA,
F7PZ-10346-KA
Lester Nos: 7776
Components: F794 (35-204) I-S-A Regulator
Features: 100% New

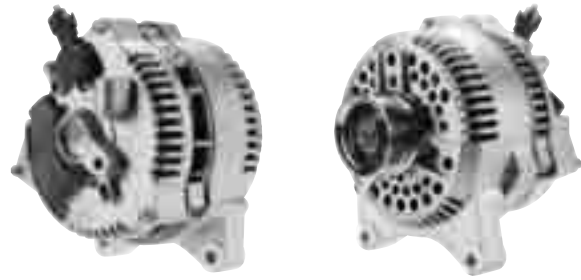

20-239-31-2

(Ref# 7776N)

Alternator - Ford 3G Series IR/IF

130A/12V, CW, 6-Groove Pulley, 10:00 Plug Clock

Used On: (2006-02) Ford E Series Van 4.6L, 5.4L, 6.8L
(2003-02) Ford F Series Pickup 4.6L, 5.4L
Replaces: Ford 2L3U-10300-BB; F6AU-10300-AA, -AB;
F6ZU-10300-AA, -AB; XL3U-10300-BA, -BB
Lester Nos: 7776
Components: 24-2254 Pulley
F794 (35-204) I-S-A Regulator
Features: 100% New

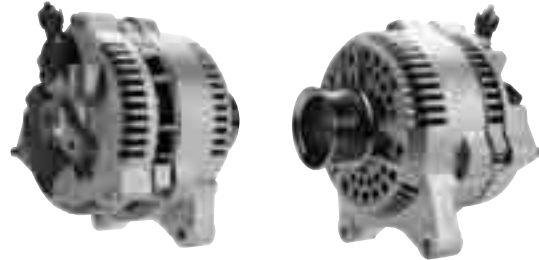

20-239-32-2

(Ref# 7791N)

Alternator - Ford 3G Series IR/IF

130A/12V, CW, 8-Groove Pulley, 10:00 Plug Clock

Used On: (2006-97) Ford E Series Van 4.6L, 5.4L, 6.8L
(2002-97) Ford Expedition 4.6L, 5.4L
(2003-97) Ford F Series Pickup 4.6L, 5.4L
Replaces: Ford F75U-10300-CA, F7UU-10300-BB,
F7UU-10300-CB
Lester Nos: 7791
Components: 24-2266 Pulley
F794 (35-204) I-S-A Regulator
Features: 100% New

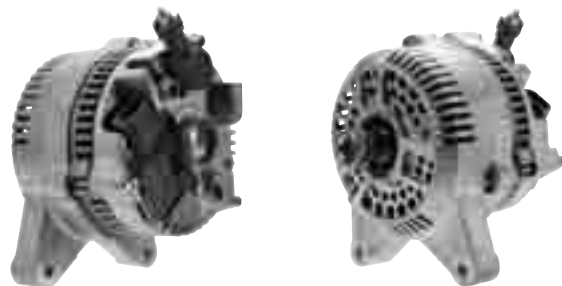

20-244-30-2

Alternator - Ford 3G Series IR/IF

95 Amp/12 Volt, CW, wo/ pulley, 10:00 Plug Clock

Used On: (2006-97) Ford F Series Pickup, E Series Van 4.6L,
5.4L, 6.8L
Replaces: Ford F6PZ-10346-RA
Lester Nos: 7790
Components: F794 (35-204) I-S-A Regulator
Features: 100% New

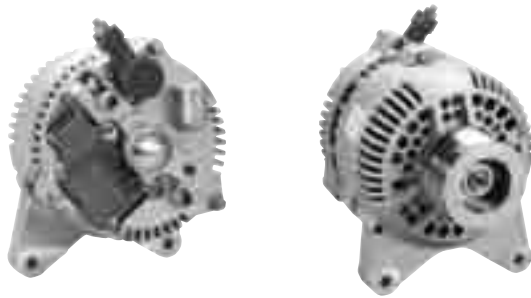

20-244-31-2
(Ref# 7790N)

**Alternator - Ford 3G Series IR/IF
95A/12V, CW, 8-Groove Pulley, 10:00 Plug Clock**

Used On: (2006-97) Ford E Series Van 4.6L, 5.4L, 6.8L
(2002-97) Ford F Series Pickup 4.6L, 5.4L, 6.8L

Replaces: Ford F7UU-10300-AB

Lester Nos: 7790

Components: 24-2266 Pulley
F794 (35-204) I-S-A Regulator

Features: 100% New



1-2173-11FD-2
(Ref# 7796N)

Alternator - Ford 6G Series IR/IF

110A/12V, CW, 8-Groove Pulley, 2:30 Plug Clock

Used On: (2003-00) Ford Excursion 7.3L Diesel
(2002-99) Ford F Series 7.3L Diesel w/ Single or Dual Alternators
(top position)

Replaces: Ford F81U-10300-EB, F81Z-10346-EA, GL-412

Lester Nos: 7796

Note: Similar to 1-2209-11FD-2 except 1-2209-11FD-2 has
extra large 10-3043-4 D.E. bearing.

For bottom position, dual alternator use 1-2178-31FD-2.

For version w/ Avalanche Diodes use 1-2511-11FD-2.

Components: 6-303-4 D.E. Bearing

21-230 D.E. Frame

24-2261-1 Pulley

F600 (35-212) I-D-A Regulator

Features: 100% New

6G (IR/IF)



1-2172-31FD-2
(Ref# 7798N)

Alternator - Ford 6G Series IR/IF

110A/12V, CW, 8-Groove Pulley, 10:30 Plug Clock

Used On: (2003-98) Ford E Series Van 7.3L Diesel w/ Dual
Alternators (bottom position)

Replaces: Ford F81U-10300-CC, F81Z-10346-CA, GL-410

Lester Nos: 7798

Note: 46-2160 battery terminal.

Similar to 1-2178-31FD-2 except 1-2178-31FD-2 has 46-2163
battery terminal.

For top position, dual alternator use 1-2209-11FD-2.

Components: 24-2269 Pulley

F600 (35-212) I-D-A Regulator

Features: 100% New



1-2178-31FD-2
(Ref# 7799N)

Alternator - Ford 6G Series IR/IF

110A/12V, CW, 8-Groove Pulley, 10:30 Plug Clock

Used On: (2002-99) Ford F Series 7.3L Diesel w/ Dual
Alternators (bottom position)

Replaces: Ford F81U-10300-GA, F81Z-10346-GA, GL-422

Lester Nos: 7799

Note: 46-2163 battery terminal.

Similar to 1-2172-31FD-2 except 1-2172-31FD-2 has 46-2160
battery terminal. For top position, dual alternator use 1-
2173-11FD-2.

For version w/ Avalanche Diodes use 1-2512-31FD-2.

Components: 24-2269 Pulley

F600 (35-212) I-D-A Regulator

Features: 100% New

FORD - ALTERNATORS

6G (IR/IF) (cont'd)



1-2209-11FD-2
(Ref# 7797N)

Alternator - Ford 6G Series IR/IF

110A/12V, CW, 8-Groove Pulley, 2:30 Plug Clock

Used On: (2003-98) Ford E Series Van 7.3L Diesel w/ Dual Alternators (top position)

Replaces: Ford F81U-10300-DB, -DC; F81Z-10346-DA, GL-411

Lester Nos: 7797

Note: Similar to 1-2173-11FD-2 except 1-2209-11FD-2 has extra large 10-3043-4 D.E. bearing.

For bottom position, dual alternator use 1-2172-31FD-2.

Components: 10-3043-4 D.E. Bearing

21-232 D.E. Frame

24-2270 Pulley

F600 (35-212) I-D-A Regulator

Features: 100% New



1-2270-31FD-2
(Ref# 8262N)

Alternator - Ford 6G Series IR/IF

110A/12V, CW, 8-Groove Pulley, 11:00 Plug Clock

Used On: (2002-99) Ford F650, F750, F800 Diesel Trucks

Replaces: Ford F81U-10300-BC, F81Z-10346-BA

Lester Nos: 8262

Note: With extra large 10-3043-4 D.E. bearing

Components: 10-3043-4 D.E. Bearing

24-2273 Pulley

F600 (35-212) I-D-A Regulator

Features: 100% New



1-2350-11FD-2
(Ref# 8261N)

Alternator - Ford 6G Series IR/IF

110A/12V, CW, 6-Groove Pulley, 2:30 Plug Clock

Used On: (2007-05) Ford F Series Pickup 4.2L

Replaces: Ford 5L3T-10300-BB, 5L3Z-10346-BA,

98AB-10300-FC, 98AZ-10346-FA

Lester Nos: 8261, 8447

Note: Similar to 1-2412-11FD except 1-2412-11FD uses F603 (35-214) Regulator (I-FR-A Terminals) and has thru bolt extension (85-1362).

Components: 24-2254 Pulley

F601 (35-213) FR-SIG-A Regulator

Features: 100% New



1-2504-31FD
(Ref# 8310N)

Alternator - Ford 6G Series IR/IF

110A/12V, CW, 6-Groove Pulley, 9:30 Plug Clock

Used On: (2005-02) Ford Excursion, F Series Pickup 5.4L, 6.8L

Replaces: Ford 2C3U-10300-AA, -AB; 2C3Z-10346-AA, -DA

Lester Nos: 8310

Components: 24-2254 Pulley

F600 (35-212) I-D-A Regulator

Features: 100% New

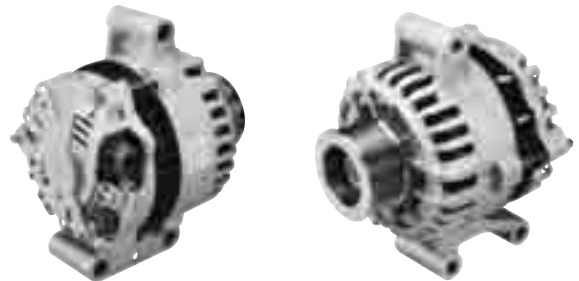

1-2511-11FD-2
(Ref# 8316N)

Alternator - Ford 6G Series IR/IF

110A/12V, CW, 8-Groove Pulley, 2:30 Plug Clock

Used On: (2003-02) Ford Excursion, F Series Pickup 7.3L Diesel wo/ Dual Alternators

(2003-02) Ford F Series Pickup 7.3 L Diesel w/ Dual Alternators (top position)

Replaces: Ford 2C3U-10300-BB, 2C3Z-10346-BA

(cont'd)

(cont'd)

Lester Nos: 8316

Note: With avalanche diodes. Will replace Ford F81U-10300-EB, F81Z-10346-EA Alternators wo/ avalanche diodes (WAI 1-2173-11FD-2, Lester 7796).

Components: 24-2261-1 Pulley
F605 (35-217) I-D-A Regulator

Features: 100% New



1-2512-31FD-2

(Ref# 8317N)

Alternator - Ford 6G Series IR/IF

110A/12V, CW, 8-Groove Pulley, 10:30 Plug Clock

Used On: (2003-02) Ford F Series Pickup 7.3L Diesel, w/ Dual Alternators (bottom position)

Replaces: Ford 2C3U-10300-CB, 2C3Z-10346-CA

Lester Nos: 8317

Note: With avalanche diodes. Will replace Ford F81U-10300-GA, F81Z-10346-GA alternators wo/ avalanche diodes (WAI 1-2178-31FD-2, Lester 7799).

Components: 24-2269 Pulley
F600 (35-212) I-D-A Regulator

Features: 100% New

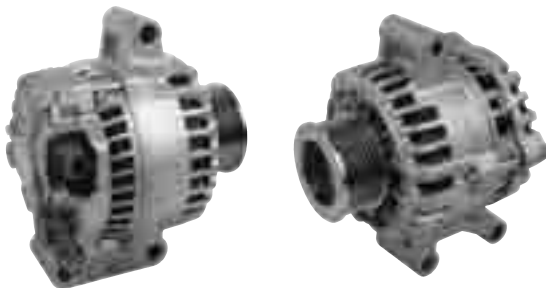

1-2531-11FD

(Ref# 8306N)

Alternator - Ford 6G Series IR/IF

110A/12V, CW, 8-Groove Pulley, 2:30 Plug Clock

Used On: (2006-04) Ford E Series Van 6.0L

(2005-03) Ford Excursion 6.0L

(2005-03) Ford F Series Pickup 6.0L

Replaces: Ford 3C3T-10300-AA, -AC, -EA; 3C3Z-10346-AA, -EA; 4C3T-10300-AA, 4C3Z-10346-AA

Lester Nos: 8306

Components: 24-2269 Pulley

F605 (35-217) I-D-A Regulator

Features: 100% New

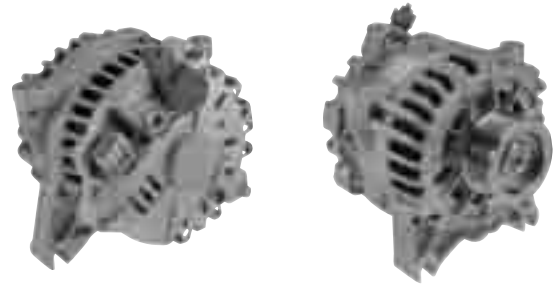

1-2539-31FD

(Ref# 8318N)

Alternator - Ford 6G Series IR/IF

110A/12V, CW, 6-Groove Pulley, 9:30 Plug Clock

Used On: (2007-04) Ford F Series Pickup 4.6L, 5.4L

Replaces: Ford 4L3U-10300-BA; 4L3Z-10346-BA, -BB

Lester Nos: 8318

Components: 24-2254 Pulley

F601 (35-213) FR-SIG-A Regulator

Features: 100% New

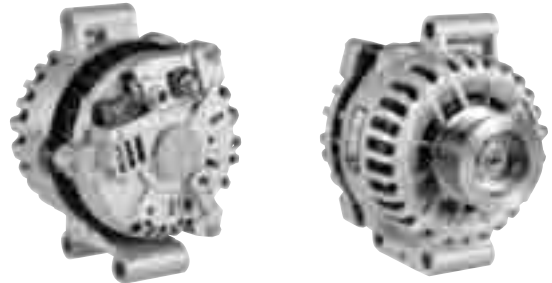

1-2667-31FD

Alternator - Ford 6G Series IR/IF

135A/12V, CW, 8-Groove Pulley, 10:30 Plug Clock

Used On: (2007-05) Ford F Series Pickup 6.0L

Replaces: Ford 5C3T-10300-BA, 5C3Z-10346-BA, 6C3T-10300-BA, 6C3Z-10346-BA

Lester Nos: 8478

Components: 24-2269 Pulley

F605 (35-217) I-D-A Regulator

Features: 100% New



1-2669-31FD

Alternator - Ford 6G Series IR/IF

110A/12V, CW, 8-Groove Pulley, 10:30 Plug Clock

Used On: (2007-06) Ford F Series Pickup 6.0L (Diesel);

Ford F450, F550 Super-Duty Trucks 6.0L (Diesel)

Replaces: Ford 5C3T-10300-DB, 5C3Z-10346-DA, 6C3T-10300-DA, 6C3Z-10346-DA

Lester Nos: 8479

Components: 24-2269 Pulley

F605 (35-217) I-D-A Regulator

Features: 100% New

HEAVY DUTY & OFF ROAD

HEAVY DUTY & OFF ROAD

FORD - GENERATORS



3-1021-FD

Generator - Ford

12 Amp/6 Volt, CW, 1-Groove Pulley

Used On: Ford 2N, 8N, 9N Farm Tractors

Replaces: Ford 8N10000, 9N10000

Lester Nos: 5792

Dim: 4-1/2" OD x 5-1/2" L Field Case

Note: 3-brush generator

Features: 100% New

(cont'd)

Replaces: Ford E25Z-11002-A, E3AZ-11002-A, E4DZ-11002-B

Lester Nos: 3180

Note: Also replaces Lester Nos. 3124, 53, 68

Features: 100% New



2-1649-FD

(Ref# 3188N)

Starter - Ford 4" MOD II

12 Volt, CW, 9-Tooth Pinion

Used On: (1986) Ford Aerostar 2.8L

(1991-83) Ford Ranger 2.8L, 2.9L

Replaces: Ford E3TZ-11002-E, SA-746

Lester Nos: 3188

Features: 100% New

FORD - STARTERS

4" MOD II

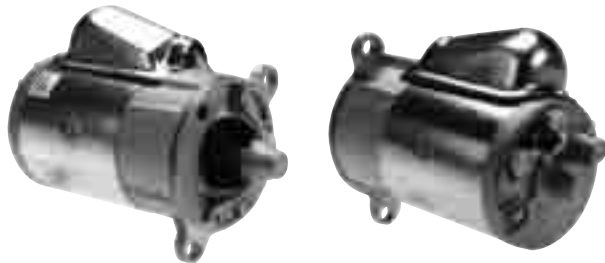

2-1642-FD

(Ref# 3185N)

Starter - Ford 4" MOD II

12 Volt, CW, 9-Tooth Pinion

Used On: (1991-83) Ford Pickup, Van 4.9L, 5.0L, 5.8L w/ MT

Replaces: Ford E3TF-11001-AA, E3TZ-11002-A, E4TF-11001-AA, E4TZ-11002-A

Lester Nos: 3185

Note: Will also replace early Ford 4-1/2" starter (Lester 3132)

Features: 100% New

4 1/2"

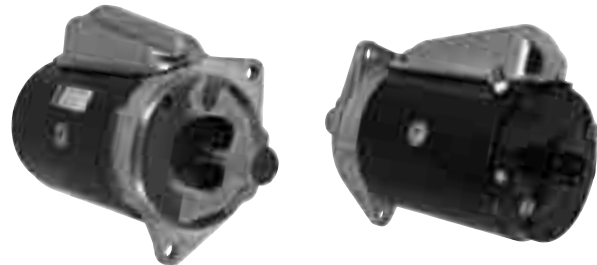

2-1668-FD

(Ref# 3124N)

Starter - Ford 4 1/2"

12 Volt, CW, 9-Tooth Pinion

Used On: (1977-65) Ford 3.9L, 4.1L, 4.3L, 4.7L, 4.9L, 5.0L, 5.8L

Replaces: Ford C2OZ-11002-B; D2AF-11001-CA, -HA; D4OZ-11002-A, D5OF-11001-AA, -BA; D6OF-11001-AA, D6OZ-11002-A

Lester Nos: 3124

Features: 100% New



2-1648-FD

(Ref# 3180N)

Starter - Ford 4" MOD II

12 Volt, CW, 9-Tooth Pinion

Used On: (1991-83) Ford E Series Van, F Series Pickup 4.9L, 5.0L w/ AT

(1984-83) Ford E Series Van, F Series Pickup 5.8L w/ AT

(1983-82) Ford F Series Pickup 3.8L w/ AT

(cont'd)



photo not available

2-1674-FD

(Ref# 3131)

Starter - Ford 4-1/2"

12 Volt, CW, 9-Tooth Pinion

Used On: (1974-73) Ford Bronco 3.3L w/ AT

(1976-73) Ford F Series Pickup 5.9L, 6.4L

(cont'd)

(cont'd)

Replaces: Ford C0DF-11001-A, -D; C1AF-11001-C, C1VF-11001-D, C2VF-11001-C, C2VY-11002-A, C3OF-11001-B, C3OZ-11002-C, C3VF-11001-A, C4OF-11001-B, C4TF-11001-B, C4TZ-11002-B, C4VF-11001-A, C5AF-11001-A, C6AF-11001-A, C6AZ-11002-A, C6VF-11001-A, C6VF-11002-A; C6VY-11002-A, -B; C7AF-11001-A, -C, -E; C7OF-11001-A, C7TF-11001-B, C8AF-11001-A, C8AZ-11002-A, C9AF-11001-B; D0AF-11001-A, -E; D0OF-11001-A, D0TF-11001-A, D2AF-11001-BA; D2OF-11001-AA, -BA; D2TF-11001-AA, -BA; D6BF-11001-BA, D6DZ-11002-B; D6TF-11001-AA, -BA, -EA; D6TZ-11002-A, -B
Lester Nos: 3131
Features: 100% New



2-1675-FD
Starter - Ford 4½" MOD
12 Volt, CW, 9-Tooth Pinion

Used On: (1981-77) Ford 5.8L, 6.6L, 7.5L
Replaces: Ford D7AZ-11002-A, -B; D8AF-11001-AA, -BA
Lester Nos: 3152
Features: 100% New

6V Early DD (Direct Drive)



2-2288-FD
 (Ref# 3109N)
Starter - Ford DD
6 Volt, CW, 9-Tooth Pinion

Used On: Ford 2N, 8N, 9N Farm Tractors
Replaces: Ford 8N11001, 8N11002, 9N11001, 9N11002
Lester Nos: 3109
Dim: 6" Shaft L
Note: Used w/ reverse mounted CCW starter drive.
Features: 100% New



2-2289-FD
 (Ref# 3110N)
Starter - Ford DD
6 Volt, CW, 9-Tooth Pinion

Used On: Ford 2N, 8N, 9N, NAA600, NAB600, NAB900
 (cont'd)

(cont'd)

Farm Tractors; Ford D, E Industrial Engines
Replaces: Ford C3NF-11001-A, FAC-11000; FAC-11001, -P; FAC-11002, -B, -G
Lester Nos: 3110
Dim: 5-3/4" Shaft L
Note: Used w/ reverse mounted CCW starter drive.
Features: 100% New

OSGR (Offset Gear Reduction)

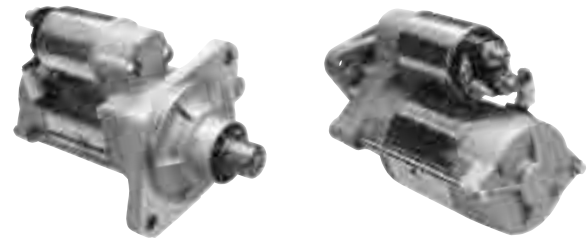

2-2197-FD-2
 (Ref# 6669N)
Starter - Ford OSGR

3.5kW/12 Volt, CW, 12-Tooth Pinion

Used On: (2003-01) Ford Excursion, F Series Pickup 7.3L (Power Stroke Diesel)
Replaces: Ford 1C3U-11000-AA, -AB, -AE; 1C3Z-11002-AA; 2C3T-11000-AA, -AB; 2C3Z-11002-AA
Lester Nos: 6669
Note: 2-2197-FD-2 will also replace 2-1748-MI (Lester 17578, Mitsubishi style, 3-mtg. ear) starters.
Features: 100% New

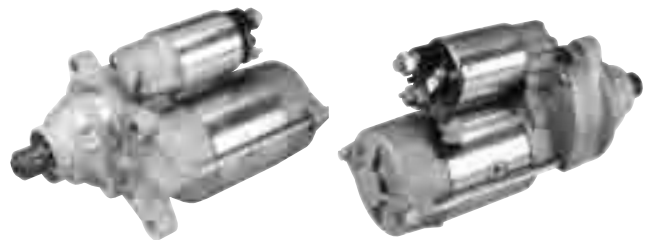

2-2215-FD
 (Ref# 6670N)

Starter - Ford OSGR

3.0kW/12 Volt, CW, 12-Tooth Pinion

Used On: (2007-03) Ford E Series Van, Excursion, F Series Pickup 6.0L (Powerstroke Diesel)
Replaces: Ford 3C3U-11000-AB, -AC; 3C3Z-11002-AA, SA-904
Lester Nos: 6670
Features: 100% New

HEAVY DUTY & OFF ROAD

HEAVY DUTY & OFF ROAD

FORD - STARTERS

PMGR (Perm. Magnet Gear Reduction)



2-1799-FD-1

(Ref# 3267N)

Starter - Ford PMGR

12 Volt, CW, 12-Tooth Pinion

Used On: (2006-97) Ford E Series Van 4.6L, 5.4L, 6.8L
(1998-97) Ford Expedition 4.6L, 5.4L
(1997) Ford F Series Pickup 4.6L

Replaces: Ford F3LY-11002-A, F7LZ-11002-BA,
F7UZ-11002-AA

Lester Nos: 3221, 3267

Features: 100% New

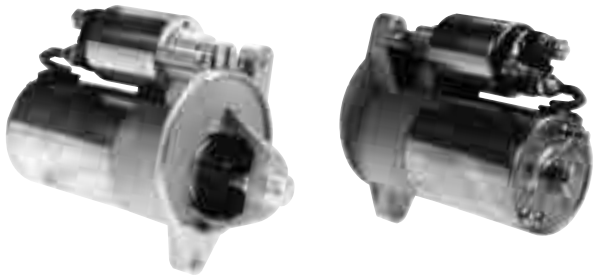

2-1806-FD-1

(Ref# 3268N)

Starter - Ford PMGR

12 Volt, CW, 10-Tooth Pinion

Used On: (1996-92) Ford Bronco 4.9L, 5.0L, 5.8L w/ AT
(2002-92) Ford E Series 4.2L, 4.9L, 5.0L, 5.8L
(1998-92) Ford F Series 4.2L, 4.9L, 5.0L, 5.8L

Replaces: Ford E9SZ-11002-A, F7SU-11000-AB,
F7SZ-11002-AA

Lester Nos: 3205, 3268 (Retrofits 3124, 53, 68, 80)

Features: 100% New

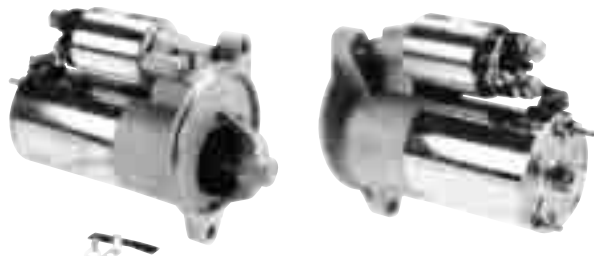

2-1881-FD-1

(Ref# 3241N)

Starter - Ford PMGR

12 Volt, CW, 10-Tooth Pinion

Used On: (1997-92) Ford Bronco, F Series 4.9L, 5.0L, 5.8L w/ MT
(cont'd)

(cont'd)

Replaces: Ford F2TU-11000-AA, F2TZ-11002-A,
F7PU-11000-FA, F7PZ-11002-FA

Lester Nos: 3223, 3241 (Retrofits 3132, 76, 85)

Note: For commercial & fleet Nippondenso OSGR design use
2-2072-ND.

Features: 100% New

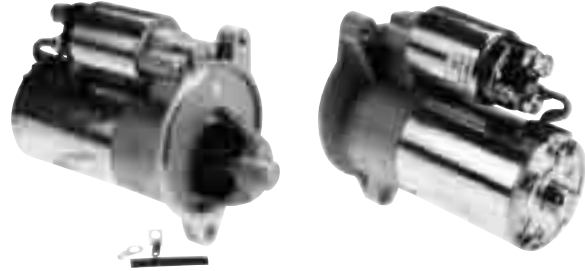

2-1882-FD-1

(Ref# 3246N)

Starter - Ford PMGR

12 Volt, CW, 10-Tooth Pinion

Used On: (1997-92) Ford F Series 7.5L w/ MT

Replaces: Ford F2TU-11000-CA, F2TZ-11002-C,
F7PU-11000-HA, F7PZ-11002-HA

Lester Nos: 3225, 3246

Features: 100% New

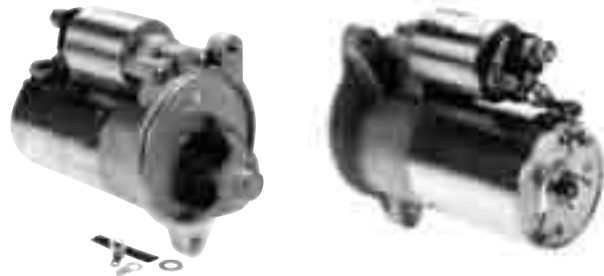

2-1883-FD-1

(Ref# 3247N)

Starter - Ford PMGR

12 Volt, CW, 10-Tooth Pinion

Used On: (1997-92) Ford Pickup, Van 7.5L w/ AT

Replaces: Ford F2TU-11000-BA, F2TZ-11002-B,
F7PU-11000-GA, F7PZ-11002-GA

Lester Nos: 3226, 3247

Features: 100% New

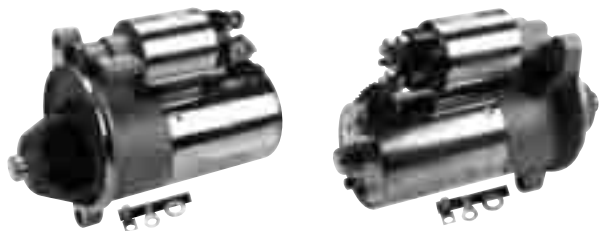

2-1885-FD-1

(Ref# 3239N)

Starter - Ford PMGR

12 Volt, CW, 10-Tooth Pinion

Used On: (1996-90) Ford Aerostar, Explorer, Ranger 4.0L
(1992) Ford Ranger 2.9L
(cont'd)

(cont'd)

Replaces: Ford F0TZ-11002-B, F7PZ-11002-KA

Lester Nos: 3224, 3239

Features: 100% New



2-1886-FD-1

(Ref# 3273N)

Starter - Ford PMGR

12 Volt, CW, 10-Tooth Pinion

Used On: (1997) Ford Aerostar 4.0L

(2007-98) Ford Ranger 4.0L w/ AT

Replaces: Ford F89Z-11002-BA

Lester Nos: 3273

Features: 100% New

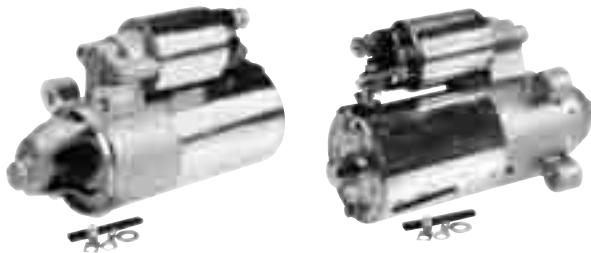

2-1887-FD-1

(Ref# 3272N)

Starter - Ford PMGR

12 Volt, CW, 10-Tooth Pinion

Used On: (1997) Ford Aerostar 3.0L

(2005-98) Ford Ranger 3.0L

Replaces: Ford 3L54-11000-AA, 3L5A-11000-AA, 3L5Z-11002-AA, F89U-11000-AA, F89Z-11002-AA

Lester Nos: 3272

Features: 100% New

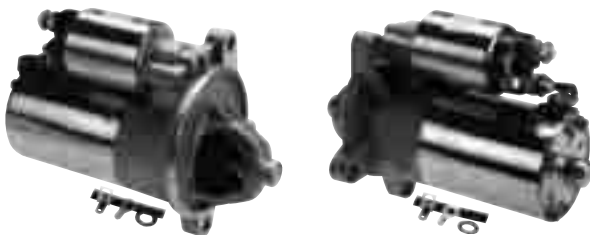

2-1894-FD-1

(Ref# 3238N)

Starter - Ford PMGR

12 Volt, CW, 10-Tooth Pinion

Used On: (2002-91) Ford Ranger 2.3L, 2.5L

Replaces: Ford F1TZ-11002-A, F87Z-11002-AA

Lester Nos: 3231, 3238

Features: 100% New



2-1895-FD-1

(Ref# 3240N)

Starter - Ford PMGR

12 Volt, CW, 10-Tooth Pinion

Used On: (2005-97) Ford Explorer 4.0L w/ MT

(2006-98) Ford Ranger 4.0L w/ MT

Replaces: Ford F87U-11000-BA, F87Z-11002-BA

Lester Nos: 3240

Features: 100% New

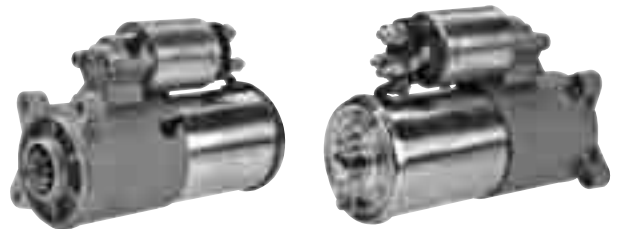

2-1910-FD-1

(Ref# 6646N)

Starter - Ford PMGR Noseless

12 Volt, CW, 12-Tooth Pinion

Used On: (2005-00) Ford Excursion 5.4L, 6.8L

(2004-99) Ford Expedition 4.6L

(2006-99) Ford Expedition 5.4L

(2005-99) Ford F Series Pickup 4.6L, 5.4L, 6.8L

Replaces: Ford F81Z-11002-AA

Lester Nos: 6646

Features: 100% New

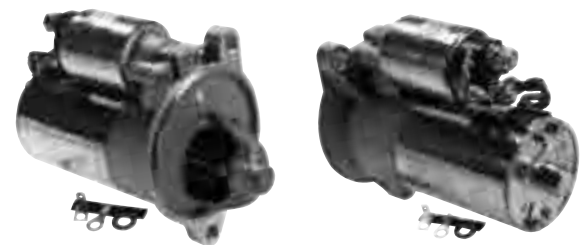

2-1953-FD-1

(Ref# 3235N)

Starter - Ford PMGR

12 Volt, CW, 10-Tooth Pinion

Used On: (1996-93) Ford F Series 7.0L w/ MT

Replaces: Ford F2HT-11000-AA, F2HZ-11002-A, F7PU-11000-DA, F7PZ-11002-DA, SA-854

Lester Nos: 3235, 6640

Features: 100% New

HEAVY DUTY & OFF ROAD

HEAVY DUTY & OFF ROAD

FORD - STARTERS

PMGR (Perm. Magnet Gear Reduction) (cont'd)



2-1955-FD-1
(Ref# 6647N)

Starter - Ford PMGR Noseless
12 Volt, CW, 10-Tooth Pinion

Used On: (2005-99) Ford F Series Pickup 4.2L
Replaces: Ford XL1U-11000-AA, -AB; XL1Z-11002-AA
Lester Nos: 6647
Features: 100% New

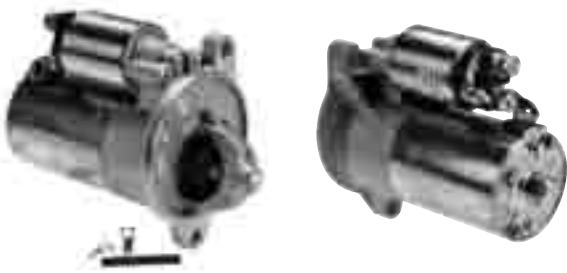

2-1956-FD-1
(Ref# 6641N)

Starter - Ford PMGR
12 Volt, CW, 10-Tooth Pinion

Used On: (1996-93) Ford F Series Trucks 7.0L w/ AT
Replaces: Ford F2HT-11000-BA, F2HZ-11002-B, F7PU-11000-EA, F7PZ-11002-EA
Lester Nos: 3234
Features: 100% New

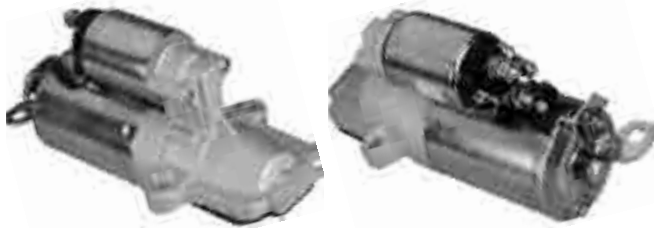

2-2218-FD
(Ref# 6657N)

Starter - Ford PMGR
12 Volt, CW, 11-Tooth Pinion

Used On: (2007-01) Ford Ranger 2.3L
Replaces: Ford 1L5T-11000-AA, 1L5Z-11002-AA
Lester Nos: 6657
Features: 100% New

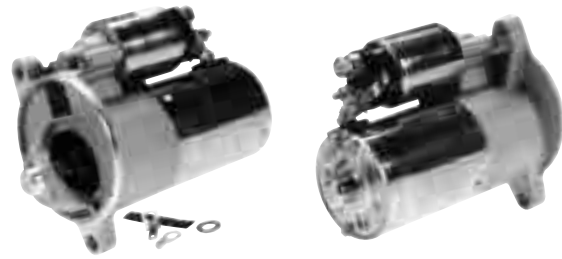

50-220-1
(Ref# 3232N)

Starter - Ford PMGR
12 Volt, CW, 10-Tooth Pinion

Used On: (1997-90) Ford Explorer, Ranger 4.0L w/ MT
Replaces: Ford F07U-11000-AA, F0TZ-11002-A
Lester Nos: 3232
Features: 100% New

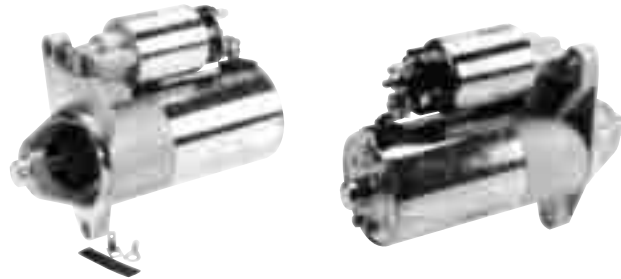

50-237-1

Starter - Ford PMGR
12 Volt, CW, 10-Tooth Pinion

Used On: (1997) Ford Aerostar, Explorer, Ranger 4.0L w/ AT
Replaces: Ford F77U-11000-AA, F77Z-11002-AA
Lester Nos: 3271
Features: 100% New

HITACHI - ALTERNATORS

ER/EF (Ext. Reg./Ext. Fan)



1-1111-02HI

Alternator - Hitachi ER/EF
35 Amp/12 Volt, CW, 2-Groove Pulley

Used On: Nissan Lift Trucks w/ SD22, SD25 Diesel Engines
Replaces: Hitachi LT135-24, -24B, -73, -73B, -87; Hyster 3004578; Nissan 23100-90060, -90065, -L1802
Lester Nos: 14534
Features: 100% New



1-2316-01HI
Alternator - Hitachi ER/EF
35 Amp/12 Volt, CW, 1-Groove Pulley

Used On: Ford Farm Tractor 1910, 2110 w/ Shibaura Diesel
Replaces: Hitachi LT135-83B
Lester Nos: 12127
Features: 100% New, mfd. to OE specifications



1-1940-01HI
 (Ref# 14735N)
Alternator - Hitachi IR/EF
70 Amp/12 Volt, CW, 2-Groove Pulley

Used On: Isuzu Trucks
Replaces: Hitachi LR170-401, -410, -410B;
 Isuzu 8-94175-418-0, -1; 8-94175-488-0, 8-94408-365-0
Lester Nos: 14735
Dim: 16-Spline Pump Shaft, 215mm OAL
Note: Similar to 1-2271-01HI, however 1-2271-01HI has a longer 8-spline pump shaft.
Features: 100% New



1-2475-01HI
Alternator - Hitachi ER/EF
15 Amp/24 Volt, 2-Groove Pulley

Used On: Nissan Lift Trucks w/ SD33T Diesel Engine
Replaces: Hitachi LT215-37C, Hyster 3046996,
 Nissan 23100-L6001, Yale 2200074-00
Lester Nos: 12116
Features: 100% New



1-2271-01HI
 (Ref# 12097N)
Alternator - Hitachi IR/EF
70 Amp/12 Volt, CW, 2-Groove Pulley

Used On: Hino, Isuzu Truck
Replaces: GM 94052404; Hitachi LR170-418, -418B, -418C;
 Isuzu 2-91276-000-0, 8-97023-733-1
Lester Nos: 12097
Dim: 8-Spline Pump Shaft, 191mm OAL
Note: Similar to 1-1940-01HI, however 1-1940-01HI has a shorter 16-spline pump shaft.
Features: 100% New

IR/EF (Int. Reg./Ext. Fan)



1-1112-01
 (Ref# 14231N)
Alternator - Hitachi, Mitsubishi IR/EF
35 Amp/12 Volt, CW, 1-Groove Pulley

Used On: (1980-78) Nissan 620, 720 Pickup 2.0L; Nissan Lift Trucks, TCM Lift Trucks
Replaces: Hitachi LR135-44, LR135-61B, LR138-01;
 Mitsubishi A1T22971; Nissan 23100-B9800, -B9801, -B9802, -B9805, -B9810
Lester Nos: 14231
Features: 100% New



1-2312-01HI
Alternator - Hitachi IR/EF
35 Amp/12 Volt, CW, 1-Groove Pulley

Used On: Allis-Chalmers, Deutz-Allis, Massey Ferguson Farm Tractors w/ Toyosha Diesel Engines
Replaces: Hitachi LR135-58B, Massey Ferguson 3282883-M91
Lester Nos: 12129
Features: 100% New, mfd. to OE specifications

HEAVY DUTY & OFF ROAD

HEAVY DUTY & OFF ROAD

HITACHI - ALTERNATORS

IR/EF (Int. Reg./Ext. Fan) (cont'd)



1-2313-01HI

Alternator - Hitachi IR/EF

20 Amp/12 Volt, CW, 1-Groove Pulley

Used On: Gehl Skid Steer w/ Isuzu 3KC1, 3KCR1 Engines

Replaces: Hitachi LR120-23, Isuzu 5-81200-358-0

Lester Nos: 12126

Features: 100% New



1-2314-01HI

Alternator - Hitachi IR/EF

35 Amp/12 Volt, CW, 1-Groove Pulley

Used On: Mustang Skid Steer Loader w/ Yanmar 3TN82E, 3TNA72E Engines

Replaces: Hitachi LR135-91, Yanmar 124080-77201

Lester Nos: 12288

Features: 100% New



1-2317-01HI

Alternator - Hitachi IR/EF

65 Amp/12 Volt, CW, 2-Groove Pulley

Used On: UD Nissan Diesel Truck 6.9L, 7.4L

Replaces: Hitachi LR165-03, Nissan 23100-95013

Lester Nos: 12237

Features: 100% New, mfd. to OE specifications



1-2332-01HI

Alternator - Hitachi IR/EF

35 Amp/12 Volt, CW, 1-Groove Pulley

Used On: Iseki Tractors, Takeuchi, TCM Lift Trucks w/ Isuzu Engines

Replaces: Hitachi LR135-86, -86C, -86F, -95, -95B, -115, -116, 127; Iseki 6581-200-338-0, 6581-200-349-0;

Isuzu 5-81200-338-1; 5-81200-341-0, -1; 8-94423-756-0

Lester Nos: 12115

Features: 100% New, mfd. to OE specifications



1-2358-01HI

Alternator - Hitachi IR/EF

80 Amp/12 Volt, CW, 3-Groove Pulley

Used On: Isuzu NPR Diesel Trucks

Replaces: Hitachi LR180-509; Isuzu 8-97116-697-3, 8-97189-650-0

Lester Nos: 12335

Dim: 8-Spline, 14.6mm OD x 42mm L Pump Shaft

Note: Similar to 1-2496-01HI, however 1-2496-01HI has a shorter 26mm L pump shaft.

Features: Remfd. by OE supplier



1-2470-01HI

(Ref# 12234N)

Alternator - Hitachi IR/EF

80 Amp/12 Volt, CW, 6-Groove Pulley

Used On: Isuzu NPR Trucks w/ 5.7L GM Engines

Replaces: Hitachi LR180-502, B; Isuzu 8-97037-064-0

Lester Nos: 12234

Features: 100% New



1-2471-01HI

Alternator - Hitachi IR/EF

20 Amp/24 Volt, CW, 1-Groove Pulley

Used On: TCM Lift Trucks w/ Isuzu C240 Diesel Engine

Replaces: Hitachi LR220-24; Isuzu 5-81200-335-0

Lester Nos: 12114

Note: Will also replace Hitachi LR220-23, Isuzu 5-81200-330-0 alternator used on Isuzu Industrial Engines, however will need to reuse original pulley.

Features: 100% New, mfd. to OE specifications



1-2472-01HI

Alternator - Hitachi IR/EF

20 Amp/24 Volt, CW, 1-Groove Pulley

Used On: Isuzu Industrial Engine 3KR1

Replaces: Hitachi LR220-26, Isuzu 8-94426-447-0

Lester Nos: 12322

Features: 100% New, mfd. to OE specifications



1-2473-01HI

Alternator - Hitachi IR/EF

20 Amp/24 Volt, CW, 1-Groove Pulley

Used On: Isuzu Industrial Engine 4JB1

Replaces: Hitachi LR220-27, B; Isuzu 8-94338-847-0, -1

Lester Nos: 12323

Features: 100% New



1-2474-01HI

Alternator - Hitachi IR/EF

25 Amp/24 Volt, CW, 2-Groove Pulley

Used On: Nissan F03 Series Lift Trucks w/ TD42 Diesel Engine

Replaces: Hitachi LR225-84T, Nissan 23100-51H00

Lester Nos: 12324

Features: 100% New



1-2481-01HI

(Ref# 12118N)

Alternator - Hitachi IR/EF

40 Amp/12 Volt, CW, 1-Groove Pulley

Used On: Nissan H02, KH02 Lift Trucks w/ SD25 Diesel Engine

Replaces: Hitachi LR140-130B, P; Nissan 23099-R8103, -R8109

Lester Nos: 12118

Features: 100% New



1-2482-01HI

(Ref# 70415N)

Alternator - Hitachi IR/EF

70 Amp/12 Volt, CW, 1-Groove Pulley

Used On: Isuzu Opel 4EE1T Diesel Engine

Replaces: Hitachi LR170-415; Isuzu 8-94332-581-1, -2

Features: 100% New

HEAVY DUTY & OFF ROAD

HEAVY DUTY & OFF ROAD

HITACHI - ALTERNATORS

IR/EF (Int. Reg./Ext. Fan) (cont'd)

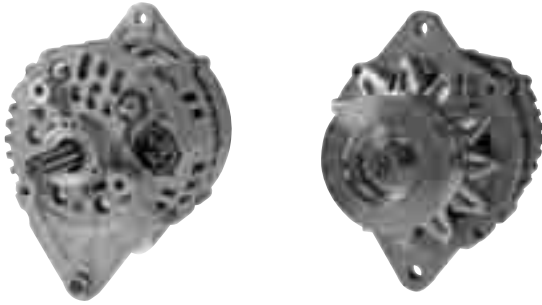

1-2495-01HI
(Ref# 12235N)

Alternator - Hitachi IR/EF
80 Amp/12 Volt, CW

Used On: Isuzu NPR Trucks w/ 4BD1 3.9L Engine
Replaces: Hitachi LR180-503B, C, Isuzu 2-91276-300-0
Lester Nos: 12235
Features: 100% New



1-2496-01HI

Alternator - Hitachi IR/EF
80 Amp/12 Volt, 3-Groove Pulley

Used On: Isuzu
Replaces: Hitachi LR180-510; Isuzu 8-97189-549-0, 8-97189-649-0
Lester Nos: 12336
Dim: 8-Spline, 14.6mm OD x 26mm L Pump Shaft
Note: Similar to 1-2358-01HI, however 1-2358-01HI has a longer 42mm L pump shaft.
Features: Remfd. by OE supplier

IR/IF (Int. Reg./Int. Fan)



1-2315-01
(Ref# 12112N, 3163M)

Alternator - Hitachi IR/IF Replacement
40 Amp/12 Volt, CW, 1-Groove Pulley

Used On: John Deere Skid Steer Loaders w/ Yanmar Engines, (cont'd)

(cont'd)

Yanmar Diesel Generator Sets

Replaces: Hitachi LR140-714, -714B; John Deere AM878581; Yanmar 119836-77200, 119836-77200-2, 119836-77200-3

Lester Nos: 12112

Features: 100% New



1-2469-01HI

Alternator - Hitachi IR/IF
45 Amp/12 Volt, 1-Groove Pulley

Used On: Isuzu Industrial Engines
Replaces: Hitachi LR145-707, Isuzu 8-94338-096-0
Lester Nos: 12279
Features: 100% New, mfd. to OE specifications

HITACHI - STARTERS

DD (Direct Drive)



2-1724-HI-1

Starter - Hitachi DD Replacement
0.8kW/12 Volt, CW, 9-Tooth Pinion

Used On: Nissan Lift Truck NFG101 w/ D11 Engine
Replaces: Hitachi S114-150, -150L, -164; Nissan 23300-47601, -48300, -48301

Lester Nos: 16207

Note: Replacement design



2-1736-HI-1
(Ref# 18110)

Starter - Hitachi DD Replacement
1.2kW/12 Volt, CW, 9-Tooth Pinion

Used On: Komatsu Lift Truck FG40Z, TCM Lift Truck FG35N3
Replaces: Hitachi S114-184, Nissan 23300-C0600

Lester Nos: 18110

Note: Replacement design



2-1855-HI
Starter - Hitachi DD
1.0kW/12 Volt, CW, 9-Tooth Pinion
Used On: Gehl Skid Steer, Hydra-Mac Equipment w/ Isuzu 3K, 3KC1, 3KCR1 Engines
Replaces: Hitachi S114-385; Isuzu 5-81100-192-0, -1
Lester Nos: 18056
Features: 100% New, mfd. to OE specifications



2-2007-HI
Starter - Hitachi DD
1.2kW/12 Volt, CW, 9-Tooth Pinion
Used On: Boss Light Towers; Ford 1310, 1510 Farm Tractors w/ 3-Cyl. Diesel Engine; Lincoln Welder, Onan
Replaces: Hitachi S114-381, Ishikawajima 185086321, Onan 185-2166
Lester Nos: 17300
Features: 100% New, mfd. to OE specifications



2-2026-HI
 (Ref# 17294)
Starter - Hitachi DD
2.2kW/12 Volt, CW, 10-Tooth Pinion
Used On: Ford 4610 Farm Tractor; Ford 540A, 540B, 545A Tractors; Gehl Skid Steer, Mustang Skid Steer Loader
Replaces: Ford D9NN-11000-AA; Hitachi S13-61, S13-61A
Lester Nos: 17294
Note: Replaces Lucas M50 series starter



2-2317-HI
Starter - Hitachi DD
1.8kW/12 Volt, CW, 9-Tooth Pinion
Used On: Ford Farm Tractors w/ 2-77, 2-78 Shibaura Diesels
Replaces: Hitachi S12-62, Ishikawajima 185086052
Lester Nos: 17331
Features: 100% New, mfd. to OE specifications



2-2737-HI-2
 (Ref# 18289N)
Starter - Hitachi DD
2.2kW/12 Volt, CW, 10-Tooth Pinion
Used On: Massey Ferguson Tractors w/ Perkins 4-318, 4-236, 4-248, 6-354 Diesel Engines
Replaces: Hitachi S13-73, Massey Ferguson 2873D001
Lester Nos: 18289
Features: 100% New

OSGR (Offset Gear Reduction)



2-1193-HI
 (Ref# 18050N)
Starter - Hitachi OSGR
2.0kW/12 Volt, CW, 9-Tooth Pinion
Used On: Hyster, TCM Lift Trucks w/ Isuzu C240 Diesel Engines
Replaces: Hitachi S13-82, A, B; Isuzu 8-94136-400-0, -1
Lester Nos: 18050
Note: Will also replace Hitachi DD Starter: S13-28 (Lester 18064)
Features: 100% New

HITACHI - STARTERS

OSGR (Offset Gear Reduction) (cont'd)



2-1734-HI
(Ref# 17088N)

Starter - Hitachi OSGR
12 Volt, CW, 9-Tooth Pinion

Used On: Thermo King
Replaces: Hitachi S12-41A, S12-59; S13-84, -84A, -84B; Isuzu 5-81100-103-0, 8-94149-249-0; Thermo King 44-2918, 44-5443, 45-1229, 45-1285
Lester Nos: 17088
Features: 100% New



2-1776-HI
(Ref# 18067N)

Starter - Hitachi OSGR
2.0kW/12 Volt, CW, 9-Tooth Pinion

Used On: Thermo King w/ Isuzu Engine
Replaces: Hitachi S13-89A, -89B, -89C; S13-289, -289A; Isuzu 8-94147-549-2, 8-94429-977-0; Thermo King 45-1263
Lester Nos: 18067
Note: 32mm Pinion OD
Features: 100% New



2-2006-HI
Starter - Hitachi OSGR
2.2kW/12 Volt, CW, 9-Tooth Pinion

Used On: Isuzu Industrial 2AB1, 3AB1, 4JB1, C190, C190M Engines; Mustang Skid Steer Loader 960, Takeuchi TL26 w/ Isuzu 4JB1 Engine
Replaces: Hitachi S13-111, -136; Isuzu 8-94410-409-0, (cont'd)

(cont'd)
8-97084-877-0
Lester Nos: 18299
Note: Will also replace Hitachi DD Starters: S12-48, S12-58 (Lester 18298)
Features: 100% New, mfd. to OE specifications



2-2012-HI
(Ref# 18054N)

Starter - Hitachi OSGR
1.4kW/12 Volt, CW, 9-Tooth Pinion

Used On: Nissan Lift Trucks, TCM Equipment w/ Nissan TB42 Engine
Replaces: Hitachi S114-482, -482A; Nissan 23300-52H00, 23300-K8405
Lester Nos: 18054
Features: 100% New



2-2014-HI
(Ref# 18061)

Starter - Hitachi OSGR
2.0kW/12 Volt, CW, 9-Tooth Pinion

Used On: Nissan Lift Trucks w/ SD25 Diesel Engine
Replaces: Hitachi S13-104, Nissan 23300-83W00
Lester Nos: 18061
Features: 100% New, mfd. to OE specifications



2-2037-HI
(Ref# 18059N)

Starter - Hitachi OSGR
4.5kW/24 Volt, CW, 11-Tooth Pinion

Used On: Nissan Lift Truck F05 w/ FD6 Diesel Engine
Nissan Lift Truck YE03, YGF03 w/ SD33T Diesel Engine (cont'd)

(cont'd)

Replaces: Hitachi S25-64, B, E, F; S25-110A, C, G; S25-164A; Nissan 23300-L6000, -Z5000, -Z5005, -Z5505, -Z5507, -Z5515
Lester Nos: 18059, 18062
Features: 100% New

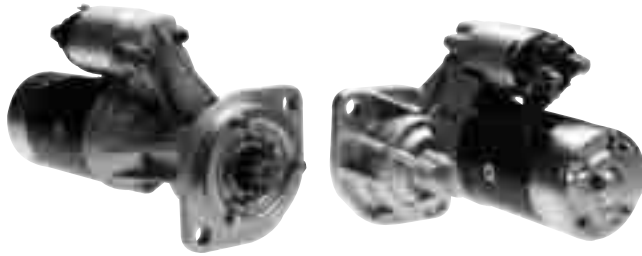

2-2100-HI
 (Ref# 18281N)

Starter - Hitachi OSGR
3.5kW/24 Volt, CW, 9-Tooth Pinion

Used On: Industrial Equipment w/ Isuzu 4JB1 Diesel Engine
Replaces: Hitachi S24-07, Isuzu 8-94423-452-0
Lester Nos: 18281
Features: 100% New



2-2101-HI-2
 (Ref# S6143N)

Starter - Hitachi OSGR
3.2kW/24 Volt, CW, 10-Tooth Pinion

Used On: Nissan Bus w/ ED33 Diesel Engine
Replaces: Hitachi S24-01B, -10C, -10D; S25-125, -125A, -125B; Nissan 23300-T9000, -T9002, -T9003
Lester Nos: 18287
Features: 100% New



2-2230-HI
 (Ref# 18280N)

Starter - Hitachi OSGR
3.5kW/24 Volt, CW, 9-Tooth Pinion

Used On: Isuzu ELF Trucks w/ 4BC2, 4BD1 Engines
Replaces: Hitachi S24-03C, Isuzu 8-94333-438-0
Lester Nos: 18280
Features: 100% New

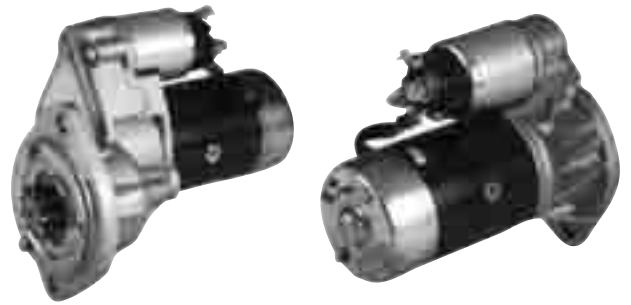

2-2231-HI
 (Ref# 18284N)

Starter - Hitachi OSGR
3.5kW/24 Volt, CW, 9-Tooth Pinion

Used On: Isuzu ELF Trucks w/ 4BA1 Engine
Replaces: Hitachi S25-120, A; Isuzu 5-81100-128-0, -1, -2
Lester Nos: 18284
Features: 100% New



2-2233-HI
 (Ref# S6107N)

Starter - Hitachi OSGR
4.0kW/24 Volt, CCW, 11-Tooth Pinion

Used On: Isuzu Elf NPR66, NKS58, NKR66 Trucks w/ 4BE1, 4HF1 Diesel Engines
Lester Nos: 18960
Replaces: Hitachi S25-163A, B, C; Isuzu 8-97032-464-0, 8-97032-464-2, 8-97065-526-0



2-2235-HI
 (Ref# S6008N)

Starter - Hitachi OSGR
2.0kW/12 Volt, CW, 9-Tooth Pinion

Used On: Nissan Lift Trucks FD15, JO2
Replaces: Hitachi S13-106A, B; Nissan 23300-10T01, 23300-80G00
Features: 100% New

HEAVY DUTY & OFF ROAD

HEAVY DUTY & OFF ROAD

HITACHI - STARTERS

OSGR (Offset Gear Reduction) (cont'd)

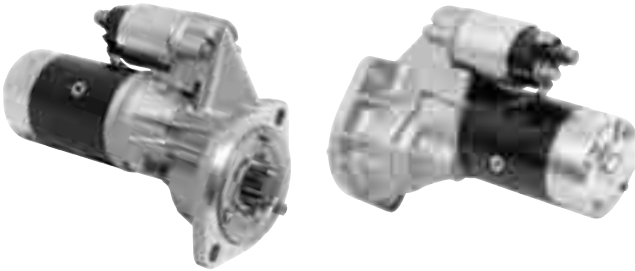

2-2264-HI

(Ref# 18285N)

Starter - Hitachi OSGR

3.5kW/24 Volt, 9-Tooth Pinion

Used On: Isuzu Industrial C190, C240 Diesel Engines
Replaces: Hitachi S25-121, -121A; Isuzu 5-81100-129-0, -1, -2
Lester Nos: 18285
Features: 100% New



2-2311-HI

Starter - Hitachi OSGR

1.4kW/12 Volt, CW, 9-Tooth Pinion

Used On: Isuzu Industrial Engine 3KC1
Replaces: Hitachi S114-429, A; Isuzu 8-94133-338-0, -1
Lester Nos: 17079
Features: 100% New, mfd. to OE specifications



2-2318-HI

Starter - Hitachi OSGR

2.0kW/12 Volt, CW, 9-Tooth Pinion

Used On: Carrier-Transcold, Thermo King w/ Yanmar Diesel Engine
Replaces: Hitachi S13-207A, -207C; Yanmar 126486-77010, 129486-77011
Lester Nos: 18490
Note: 35.5mm Pinion OD



2-2319-HI

Starter - Hitachi OSGR

3.5kW/12 Volt

Used On: UD Nissan 1300, 1400 Truck 4.2L Diesel
Replaces: Hitachi S14-02, -20; Nissan 23300-05D00, -05D01
Lester Nos: 18215
Features: 100% New, mfd. to OE specifications



2-2320-HI-1

(Ref# 17801N)

Starter - Hitachi OSGR

2.2kW/12 Volt, CW, 9-Tooth Pinion

Used On: (2006-01) Chev. Silverado, GMC Sierra 6.6L (Diesel)
Replaces: Delco 97209548, 97720446; Hitachi S14-100D, E; S14-101A; Isuzu 8-97209-548-3, 8-97209-548-4
Lester Nos: 17801
Features: 100% New



2-2321-HI

(Ref# 18058)

Starter - Hitachi OSGR

3.5kW/24 Volt, CW, 11-Tooth Pinion

Used On: Nissan F03 Series Lift Trucks w/ TD42 Diesel Engine
Replaces: Hitachi S25-158A, B; Nissan 23300-06J01, -06J02, -06J04
Lester Nos: 18058
Features: 100% New, mfd. to OE specifications



2-2715-HI-2
(Ref# 17801N-24V)

Starter - Hitachi OSGR
24 Volt, CW, 9-Tooth Pinion

Used On: Chev. Silverado, GMC Sierra 6.6L (Diesel) w/ 24V System

Note: 24V version of WAI 2-2320-HI, Lester 17801

Features: 100% New



2-2758-HI-2
(Ref# 77010N)

Starter - Hitachi OSGR
2.3kW/12 Volt, CW, 9-Tooth Pinion

Used On: Samsung SE50-3 Mini-Excavator w/ Yanmar 4TNE94 Diesel Engines

Replaces: Hitachi S13-204; Yanmar 129900-77010

Lester Nos: 18491

Features: 100% New

ISKRA - ALTERNATORS



1-2435-01B0
(Ref# 12151N)

Alternator - Iskra IR/IF
95 Amp/12 Volt

Used On: John Deere Farm & Industrial Tractors w/ 4-239, 6-359 Diesel Engines

Replaces: Bosch 0-120-484-002, -003, -016, -020; Iskra 11-201-989; John Deere AL6033, AL67176, AL78690, AL81437

Lester Nos: 12151

Note: Internal fan replacement for Bosch external fan alternators.

Features: 100% New mfd. by Iskra



1-2455-01MM
(Ref# 12095N)

Alternator - Iskra IR/IF
100 Amp/12 Volt, 8-Groove Pulley

Used On: Ford New Holland Farm Tractors 8160, 8360, 8560, 9360 w/ 6-456 Diesel Engine

Replaces: Iskra 11-203-087, AAK5354; Marelli 63321347, 63321753; New Holland 82002329, 82010243

Lester Nos: 12095

Features: 100% New, mfd. by Iskra

LEECE-NEVILLE - ALTERNATORS

2300-2800JB Series



20-501-1
(Ref# 7611N)

Alternator - Leece-Neville 2600JB Series
105 Amp/12 Volt, Neg. or Pos. Grd., wo/ pulley

Used On: Dodge Truck, Ford Truck, Freightliner, International, Kenworth, Mack, Peterbilt, Volvo, Western Star, White Trucks

Replaces: Ford D4HZ-10346-N; D7HT-10300-CA, -DA, -EA; D8HZ-10346-A, -B, -C; E8HT-10300-JA, -KA; E8HZ-10346-J, E9HT-10300-BA; IHC 1664631C91, 1664632C91, 1664633C91, 513303C91, 513542C91, 514089C91, 585946C91, 585947C91; Leece-Neville 2300J, 2500J, 2600J; Mack 2MJ4112P2, P3; Western Star 02-7014930, 02-7014931; White 02-7023152

Lester Nos: 7602, 7608, 7611

Features: 100% New

HEAVY DUTY & OFF ROAD

HEAVY DUTY & OFF ROAD

LEECE-NEVILLE - ALTERNATORS

2300-2800JB Series (cont'd)

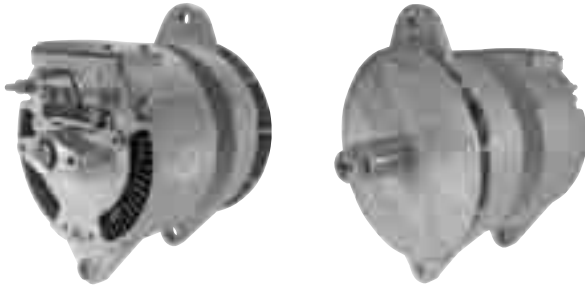

20-502-1

(Ref# 7612N, 3197M-HO)

Alternator - Leece-Neville 2700JB Series

130 Amp/12 Volt, Neg. or Pos. Grd., wo/ pulley

Used On: Dodge Truck, Ford Truck, Freightliner, International, Peterbilt, Volvo Truck, Western Star

Replaces: Cummins 216040, 3604234RX; Ford E8HZ-10346-K; F7HT-10300-GA, -HA; F7HZ-10346-GA, -HA; GM 2009386; Leece-Neville 2700J; Western Star 802010018

Lester Nos: 7612

Features: 100% New



20-504-1

(Ref# 7613N)

Alternator - Leece-Neville 2800JB Series

160 Amp/12 Volt, Neg. or Pos. Grd., wo/ pulley

Used On: Dodge Truck, Ford Truck, Freightliner, International, Peterbilt, Volvo Truck, Western Star

Replaces: GM 2009669; IHC 1618318C91, 1664634C91, 527890C91, 547269C91, 585948C91; Leece-Neville 2800JB

Lester Nos: 7613

Features: 100% New

4800 Series

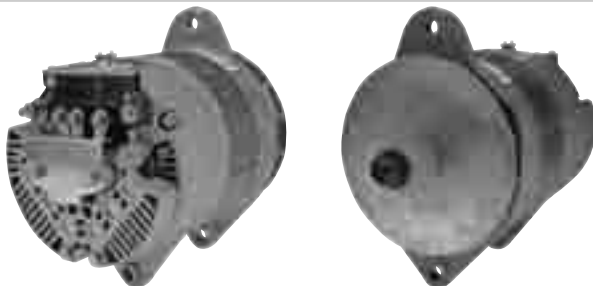

1-2652-00LN

Alternator - Leece-Neville 4836AAH Series

185 Amp/12 Volt, CW, wo/ Pulley

Replaces: Leece-Neville 4836AAH, A0014836AAH

Lester Nos: 8674

Features: 100% New



1-2653-00LN

Alternator - Leece-Neville 4860J Series

200 Amp/12 Volt, CW, wo/ Pulley

Replaces: Leece-Neville 4860J, 4860JB; Mack Truck 2MJ54

Lester Nos: 8320

Features: 100% New



1-2655-00LN

Alternator - Leece-Neville 4800J Series

175 Amp/12 Volt, CW, wo/ Pulley

Replaces: Leece-Neville 4800J, 4800JB, A0014800JB

Lester Nos: 8663

Features: 100% New



1-2658-00LN

Alternator - Leece-Neville 4834LC Series

175 Amp/12 Volt, CW, wo/ Pulley

Replaces: Leece-Neville 4834LC

Lester Nos: 8349

Features: 100% New



1-2661-00LN
Alternator - Leece-Neville 4833LGH Series
185 Amp/12 Volt

Replaces: Leece-Neville 4833LGH, A0014833LGH
Lester Nos: 8673
Features: 100% New

LEECE-NEVILLE/MOTOROLA - ALTERNATORS

8AL Series



1-2836-11M0-2
 (Ref# 7377N)
Alternator - Motorola ER/EF
51 Amp/12 Volt

Used On: Ford Tractors & Industrial Equipment
Replaces: Ford D5NN-10300-A, -BA, -D; Motorola 8AL2056K
Lester Nos: 7377
Features: 100% New

8HA Series



20-412
Alternator - Motorola 8HA Series
37 Amp/12 Volt, Neg. Grd., wo/ pulley

Used On: Thermo King
Replaces: Motorola 8HA2003F, 10-159; Prestolite 110-159; Thermo King 44-3325
Lester Nos: 7444
Features: 100% New

8LH Series



1-2429-00M0
 (Ref# 8058N)

Alternator - Leece-Neville / Motorola 8LHA Series
140 Amp/12 Volt, wo/ Pulley, Dual Foot J-180 Mount

Used On: Heavy Duty Truck Applications
Replaces: Leece-Neville / Motorola 8LHA2070V, 8LHA2070VB, 110-555, 110-555HD
Lester Nos: 8058
Features: 100% New



1-2532-00M0
 (Ref# 8410N)

Alternator - Leece-Neville / Motorola 8LHP Series
140 Amp/12 Volt, wo/ Pulley, 4-Point Pad Mount

Used On: Heavy Duty Truck Applications
Replaces: Leece-Neville / Motorola 8LHP2170V, 8LHP2170VH, 110-555P
Lester Nos: 8410
Features: 100% New



1-2564-00LN

Alternator - Leece-Neville / Motorola 8LHA Series
160 Amp/12 Volt, wo/ Pulley, Dual Foot J-180 Mount

Used On: Heavy Duty Truck Applications
Replaces: Leece-Neville / Motorola 8LHA2070VE, 110-555JHO
Lester Nos: 8329
Features: 100% New

HEAVY DUTY & OFF ROAD

HEAVY DUTY & OFF ROAD

LEECE-NEVILLE/MOTOROLA - ALTERNATORS

8LH Series (cont'd)



1-2665-00LN

**Alternator - Leece-Neville / Motorola 8LHP Series
160 Amp/12 Volt, wo/ Pulley, 4-Point Pad Mount**

Used On: Heavy Duty Truck Applications

Replaces: Leece-Neville / Motorola 8LHP2170VE, 110-555PHO

Features: 100% New

LUCAS - ALTERNATORS



1-2454-01MM

(Ref# 12094N)

Alternator - Marelli IR/IF

100 Amp/12 Volt, 6-Groove Pulley

Used On: Ford New Holland Farm Tractors 5640, 6640, 7740, 7840, 8240, 8340 w/ 4-268, 6-401, 6-456 Diesel Engines

Replaces: Ford 65GB-10300-LA; F2NN-10B376-AA; Lucas 54022443, B; 54022527, 54022568; Marelli 63321285, 63340015, 63341285; New Holland 82003307, 82010242

Lester Nos: 12094

Features: 100% New



1-2457-01LU

(Ref# A981N)

Alternator - Lucas IR/EF

65 Amp/12 Volt, 1-Groove Pulley

Used On: Ideal for Tractor Applications

(cont'd)

(cont'd)

Features: 100% New

Universal 3-hole adjusting tension ear

Threaded B+ terminal post & optional B+ spade connection

Threaded D+ terminal post.

photo not available

1-2619-01LU

Alternator - Lucas IR/EF

45 Amp/12 Volt, CW, 1-Groove Pulley

Used On: Ford, Rover (Europe)

Massey Ferguson w/ Perkins Engines

Replaces: Ford 75AB-10300-UA, 78BB-10300-AA, 78GB-10300-BA; Lucas 23618, 23673, 23683, 23720, 23738, 23760, 23809, 23810, 23828, 23857, 23905, 23906, 23948, 23949, 23950, 24066, 24114; Massey Ferguson 1447110R91; Perkins 2871A101, 2871A121, 2871A129; Rover AJU1957

Lester Nos: 12073

Features: 100% New



1-2621-01LU-2

(Ref# 12088N)

Alternator - Lucas IR/EF

70 Amp/12 Volt, CW

Used On: Ford Tractor, Massey Ferguson, Perkins

Replaces: Lucas 24158, 24209, 24245, 24294;

Marelli 54022220, 54022382, 54022383, 54022395, 54022408, 63324294

Lester Nos: 12088

Features: 100% New



1-2721-01LU

Alternator - Lucas IR/EF

30 Amp/24 Volt, CW, 8-Groove Pulley

Used On: Leyland DAF Trucks (Europe)

Replaces: DAF 24VA137, AELB710; Lucas 24299, 24406, 54022415, 54022578, 54022711; Perkins 2871A007, 2871A651

Lester Nos: 12428

Features: 100% New

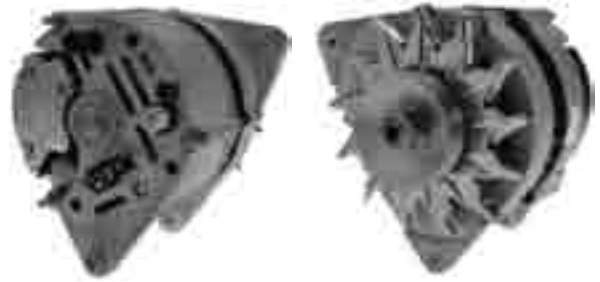

1-2762-01LU

Alternator - Lucas IR/EF

55 Amp/12 Volt, CW, 1-Groove Pulley

Used On: JCB, Massey Ferguson

Replaces: Lucas 24157, 24208, 24276, 24277, 54022053, 54022054, 54022096, 54022108, 54022182, 54022211, 54022212, 54022218, 54022219, 54022226, 54022263, 54022280, 54022295, 54022353, 54022354; Marelli 63324157, 63324276

Lester Nos: 12046

Features: 100% New



1-2730-00LU

Alternator - Lucas IR/IF

85 Amp/12 Volt, CW, wo/ Pulley

Used On: JCB (Europe)

Replaces: Lucas 54022524, Perkins 2871A156

Features: 100% New



3-1005-01LU

(Ref# 15027N)

Generator - Lucas C40T Series

22 Amp/12 Volt, wo/ pulley

Used On: Case, Ford Tractor

Replaces: Lucas 22756, 22758; Ford C7NN-10000CLPR

Lester Nos: 15027

Features: 100% New



1-2754-02LU

(Ref# 12072N)

Alternator - Lucas IR/EF

65 Amp/12 Volt, CW, 1-Groove Pulley

Used On: Case, Massey Ferguson Ag & Industrial Equipment

Replaces: Bosch 0-120-489-251, 0-120-489-252; Ford 81BB-10300-CA, 82BB-10300-GA, 84FB-10300-AAB, 85BB-10300-GA, 86AB-10300-ADA, 86FB-10300-AA, 86FB-10300-BA, 870G-10300-AA; Lucas 24145, 24161, 24200; Marelli 54022059, 54022162, 54022178, 54022186, 54022188, 54022192, 54022214, 54022217, 54022227, 54022235, 54022285, 54022291, 54022309, 54022342, 54022552, 63324145, 63324161, 63324200, 63324221

Lester Nos: 12072

Features: 100% New

LUCAS - GENERATORS

LUCAS - STARTERS

M45G, 2M113



2-2295-LU

Starter - Lucas M45G, 2M113

2.1kW/12 Volt, CW, 10-Tooth Pinion

Used On: Lancer Boss Lift Trucks w/ Perkins Engine, Lister-Petters, Waukesha Industrial
Replaces: Lister Petter 20234960, 20234963; Lucas 26166, 26286, 27419, 27481, 27489; Marelli 63227419; Perkins 2873126, 2873153
Lester Nos: 18261
Features: 100% New



2-2295-LU-1

Starter - Lucas M45G, 2M113

2.1kW/12 Volt, CW, 10-Tooth Pinion

Used On: Lancer Boss Lift Trucks w/ Perkins Engine, Lister-Petters, Waukesha Industrial
Replaces: Lister Petter 20234960, 20234963; Lucas 26166, 26286, 27419, 27481, 27489; Marelli 63227419; Perkins 2873126, 2873153
Lester Nos: 18261
Features: 100% New, mfd. by OE supplier



2-2296-LU

Starter - Lucas M45G, 2M113

2.1kW/12 Volt, CW, 10-Tooth Pinion

Used On: Case Trenchers w/ 1.8L Leyland Diesel
Replaces: Case E36646; Lucas 26371, 26400, 27431
Lester Nos: 18263
Features: 100% New



2-2300-LU

Starter - Lucas M45G, 2M113

2.1kW/12 Volt, CW, 10-Tooth Pinion

Used On: Massey Ferguson Tractors, Perkins Engines
Replaces: Lucas 26275, 26281, 27412, 27415, 27473, 27475, 27479, 27482, 27487, 27490; Marelli 63227487, 63227490
Lester Nos: 17642
Features: 100% New



2-2300-LU-1

Starter - Lucas M45G, 2M113

2.1kW/12 Volt, CW, 10-Tooth Pinion

Used On: Massey Ferguson Tractors, Perkins Engines
Replaces: Lucas 26275, 26281, 27412, 27415, 27473, 27475, 27479, 27482, 27487, 27490; Marelli 63227487, 63227490
Lester Nos: 17642
Features: 100% New, mfd. by OE supplier



2-2301-LU

(Ref# 17644N, S3526M)

Starter - Lucas M45G, 2M113

2.1kW/12 Volt, CW, 10-Tooth Pinion

Used On: Barber Greene, Massey Ferguson Tractors, Perkins Marine w/ Perkins Diesel Engines
Replaces: Bosch 0-001-362-093, 9-000-143-101, 9-000-143-108; Hitachi S12-84; Lucas 26148, 26196, 26282, 26283, 26375, 26422, 26435, 27417, 27435, 27478, 27486; Marelli 63227486; Perkins 2873121, 2873D003
Lester Nos: 17644
Features: 100% New



2-2302-LU
(Ref# 17639N)

Starter - Lucas M45G, 2M113
2.1kW/12 Volt, CW, 10-Tooth Pinion

Used On: Massey Ferguson Farm, Industrial Tractors w/ Perkins Diesel Engines

Replaces: Lucas 26154, 26200, 26220, 26264, 26412, 27409, 27459, 27469, 27470, 27474; Marelli 63227470

Lester Nos: 17639

Features: 100% New



2-2302-LU-1

Starter - Lucas M45G, 2M113
2.1kW/12 Volt, CW, 10-Tooth Pinion

Used On: Massey Ferguson Farm, Industrial Tractors w/ Perkins Diesel Engines

Replaces: Lucas 26154, 26200, 26220, 26264, 26412, 27409, 27459, 27469, 27470, 27474; Marelli 63227470

Lester Nos: 17639

Features: 100% New, mfd. by OE supplier



2-2305-LU

Starter - Lucas M45G, 2M113
2.1kW/12 Volt, CW, 10-Tooth Pinion

Used On: Massey Ferguson Tractors

Replaces: Lucas 26413, 27411, 27433; Massey Ferguson 1680064-M1

Lester Nos: 17645

Features: 100% New



2-2686-LU

Starter - Lucas M45G, 2M113
2.1kW/12 Volt, CCW, 11-Tooth Pinion

Used On: Lister Petters Ag & Industrial Equipment

Replaces: Lister Petter 20413273, Lucas 26270, 27410

Lester Nos: 17643

Features: 100% New, mfd. by OE supplier



50-9202

(Ref# 16660N)

Starter - Lucas M45G, 2M113
2.1kW/12 Volt, CW, 10-Tooth Pinion

Used On: International Farm Tractors, Industrial Equipment

Replaces: IHC 3046890-R93, Lucas 26193, 26288, 27420

Lester Nos: 16660

Features: 100% New

M50, M127



2-2281-LU

(Ref# 17072N)

Starter - Lucas M50, M127
2.8kW/12 Volt, CW, 10-Tooth Pinion

Used On: Massey Ferguson Farm, Industrial Tractors; Long Tractors w/ Perkins Diesel Engines

Replaces: Lucas 26274, 26323, 26345, 26366, 26410, 27515, 27539, 27572

Lester Nos: 17072

Features: 100% New

2-2281-LU-1

Starter - Lucas M50, M127

Note: Same as 2-2281-LU except mfd. by OE supplier

HEAVY DUTY & OFF ROAD

HEAVY DUTY & OFF ROAD

LUCAS - STARTERS

M50, M127 (cont'd)



2-2282-LU

(Ref# 16669N)

Starter - Lucas M50, M127

2.8kW/12 Volt, CW, 10-Tooth Pinion

Used On: Ford New Holland, Sperry Tractors, Massey Ferguson Tractors w/ Perkins Diesel Engines

Replaces: Lucas 26398, 27533, 27601; Massey Ferguson 1618-05-M3, 1903-145-M91

Lester Nos: 16669

Features: 100% New



2-2290-LU

Starter - Lucas M50, M127

2.8kW/12 Volt, CW, 10-Tooth Pinion

Used On: Massey Ferguson MF-275 Farm Tractors w/ Perkins AD4-248 Diesel Engine

Replaces: Lucas 26404, 27536; Massey Ferguson 579488-M91

Lester Nos: 16670

Features: 100% New



2-2291-LU

(Ref# 17648N)

Starter - Lucas M50, M127

2.8kW/12 Volt, CW, 10-Tooth Pinion

Used On: Agco Allis, Allis Chalmers, Deutz-Allis Combines, Tractors

Replaces: Allis-Chalmers 256898, 256948; Lucas 26363, 26429, 27558

Lester Nos: 17648

Features: 100% New



2-2292-LU

(Ref# 17653N)

Starter - Lucas M50, M127

2.8kW/12 Volt, CW, 10-Tooth Pinion

Used On: Agco Allis 5650, 5660 Tractors; Massey Ferguson Tractors

Replaces: Lucas 26411, 27540, 27546, 27571, 27584, 27591; Massey Ferguson 1868-283-M2, 1868-283-M3, 1868-283-M5, 579-487-M91; Perkins 2873B061

Lester Nos: 17653

Features: 100% New

2-2292-LU-1

Starter - Lucas M50, M127

Note: Same as 2-2292-LU except mfd. by OE supplier



2-2293-LU

Starter - Lucas M50, M127

2.8kW/12 Volt, CW, 10-Tooth Pinion

Used On: Barber-Greene Finishers w/ Ford 2711E, 2712E, 2714E Engines; New Holland Combines w/ Ford 6-363 Diesel Engines

Replaces: Ford 693F-11000-AA, 703F-11000-AA; Hyster 3049385; Lucas 26227, 26316, 26352

Lester Nos: 17646

Features: 100% New



2-2303-LU

(Ref# 16984N)

Starter - Lucas M50, M127

2.8kW/12 Volt, CW, 10-Tooth Pinion

Used On: Case, International, Massey Ferguson Farm Tractors

Replaces: IHC 537140-R94; Lucas 26336, 26428, 26433, 27508, 27556, 27575

Lester Nos: 16984

Features: 100% New



2-2304-LU
(Ref# 17071N)

Starter - Lucas M50, M127
2.8kW/12 Volt, CW, 10-Tooth Pinion

Used On: JC Bamford Excavators, Leyland Nuffield Tractors
Replaces: Lucas 26246, 26304, 26343, 26351, 26376, 27513, 27526
Lester Nos: 17071
Features: 100% New

2-2304-LU-1

Starter - Lucas M50, M127

Note: Same as 2-2304-LU except mfd. by OE supplier



2-2340-LU
(Ref# 17652N)

Starter - Lucas M50, M127
2.8kW/12 Volt, CW, 10-Tooth Pinion

Used On: JC Bamford Excavators, Loaders; Massey Ferguson Tractors, Perkins Diesel Engines
Replaces: Lucas 25372, 26295, 26358, 26414, 27519, 27541, 27565, 27568, 27608; Perkins 2373A029, 2378A029, 2873A031, 2873B072, 3181A032
Lester Nos: 17650, 17651, 17652
Features: 100% New

2-2340-LU-1

Starter - Lucas M50, M127

Note: Same as 2-2340-LU except mfd. by OE supplier



2-2458-LU
(Ref# 17649N)

Starter - Lucas M50, M127
2.8kW/12 Volt, CW, 10-Tooth Pinion

Used On: JC Bamford, Massey Ferguson w/ Perkins 6-354
(cont'd)

(cont'd)
Diesel Engines
Replaces: JCB 714-29300R; Lucas 26294, 26357, 26369, 27502, 27518, 27520, 27570, 27588, 27592, 27596; Marelli 63227592; Perkins 2873B056, 2873B071
Lester Nos: 17649
Features: 100% New

2-2458-LU-1

Starter - Lucas M50, M127

Note: Same as 2-2458-LU except mfd. by OE supplier



2-2459-LU

Starter - Lucas M50, M127

2.8kW/12 Volt, CW, 10-Tooth Pinion

Used On: Leyland DAF, JC Bamford Trucks
Replaces: Lucas 27564, 27595; Marelli 63227564
Lester Nos: 18065
Features: 100% New, mfd. by OE supplier



2-2687-LU
(Ref# 17647N)

Starter - Lucas M50, M127

2.8kW/12 Volt, CW, 10-Tooth Pinion

Used On: New Holland w/ Ford 280 Diesel
Replaces: Lucas 26265, 26341, 26431, 27554; Marelli 63227554
Lester Nos: 17647
Features: 100% New, mfd. by OE supplier

HEAVY DUTY & OFF ROAD

HEAVY DUTY & OFF ROAD

LUCAS - STARTERS

M50, M127 (cont'd)



50-9200

(Ref# 16608LN)

Starter - Lucas M50, M127

2.8kW/12 Volt, CW, 10-Tooth Pinion

Used On: Case Tractors; Ford Farm & Industrial Equipment; Fordson, New Holland

Replaces: Ford D4NN-11000-B; Lucas 26211, 26291, 26338, 26339, 26395, 27500, 27569

Lester Nos: 16608

Note: M127 design

Features: 100% New

50-9200-1

(Ref# 16608N, S2900M)

Starter - Lucas M50, M127

Note: Same as 50-9200 except M50 design

50-9200-2

Starter - Lucas M50, M127

Note: Same as 50-9200 except M127 design mfd. by OE supplier

MANDO - ALTERNATORS



1-2308-31MD

(Ref# 12175N)

Alternator - Mando IR/EF

55 Amp/12 Volt, CCW, 1-Groove Pulley

Used On: Bobcat, Clark

Replaces: Mando A000B0431

Lester Nos: 12175

Features: 100% New, mfd. by OE supplier



1-2462-31MD

Alternator - Mando IR/EF

55 Amp/12 Volt, 1-Groove Pulley

Used On: Tennant Street Sweepers

Replaces: Mando A000B0471K, AC155515; Tennant 60559

Note: Bidirectional Fan

Features: 100% New



1-2466-01MD

(Ref# 12390N)

Alternator - Mando IR/IF

90 Amp/12 Volt, 1-Groove Pulley

Used On: Bobcat

Replaces: Bobcat 6678205, Valeo TA000A48402

Lester Nos: 12390

Features: 100% New



1-2467-01MD

Alternator - Mando IR/EF

55 Amp/12 Volt, 2-Groove Pulley

Used On: Mitsubishi Caterpillar Forklift America

Replaces: Mitsubishi Caterpillar 91920-04200, Valeo TA000B32301

Note: Bidirectional Fan

Features: 100% New

MANDO - STARTERS



2-2306-MD
(Ref# 18486N)

Starter - Mando PLGR
2.7kW/12 Volt, CW, 11-Tooth Pinion

Used On: Bobcat
Replaces: Bobcat 6676957, 6685190; Valeo TM000A28901
Lester Nos: 18486
Features: 100% New



2-2307-MD
Starter - Mando PLGR
3.0kW/12 Volt, CW, 10-Tooth Pinion

Used On: Bobcat
Replaces: Bobcat 6676958, Valeo TM000A29001
Lester Nos: 18485
Features: 100% New



2-2308-MD
Starter - Mando DD
1.2kW/12 Volt, CW, 10-Tooth Pinion

Used On: Tennant Street Sweepers
Replaces: Tennant 392525, Valeo TM000A32601
Lester Nos: 18487
Features: 100% New

MITSUBISHI - ALTERNATORS

IR/EF (Int. Reg./Ext. Fan)



1-1929-01MI
(Ref# 12075N)

Alternator - Mitsubishi IR/EF
215 Amp/12 Volt, CW, 8-Groove Pulley

Used On: (2003-95) Ford E Series Van 7.3L (Diesel) w/ Ambulance Opt
(1997-95) Ford F Series Pickup 7.3L (Diesel) w/ Ambulance Opt
Replaces: Ford F5UU-10300-CA, F5UZ-10346-CA; Mitsubishi A8TU0091
Lester Nos: 12075
Features: 100% New



1-2391-01MI

Alternator - Mitsubishi IR/EF
35 Amp/12 Volt, CW, 1-Groove Pulley

Used On: Mitsubishi Lift Trucks w/ S4E, S4S Engines; Toro Reelmaster 4500D Mower
Replaces: Mitsubishi A1T25077, A1T25083; Mitsubishi Industries 34468-18200, -28100, -28200; Toro 51-8250, 60-5420, 60-5421, 86-6400
Lester Nos: 14687
Features: 100% New, mfd. in Japan to OE specifications



1-2434-01MI

Alternator - Mitsubishi IR/EF
50 Amp/24 Volt, 1-Groove Pulley

Used On: Canter Diesel Engines
Replaces: Hyundai 37300-41010
Features: 100% New

MITSUBISHI - ALTERNATORS

IR/IF (Int. Reg./Int. Fan)

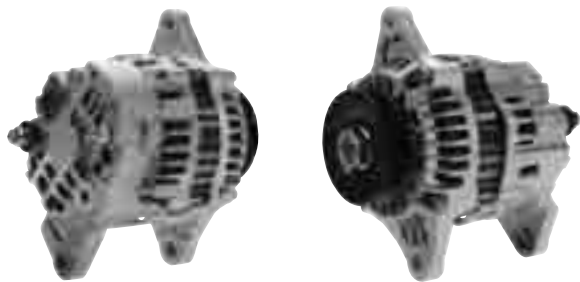

1-1960-01MI
(Ref# 12138N)

Alternator - Mitsubishi IR/IF
40 Amp/12 Volt, CW, 1-Groove Pulley

Used On: Hyster, Sumitomo, Yale Lift Trucks
Replaces: Hyster 1361853, 1450928, 3068342, 3114961, 3123908; Mazda S5SN-18-300, -300A; Mitsubishi A7T03277
Lester Nos: 12138
Features: 100% New

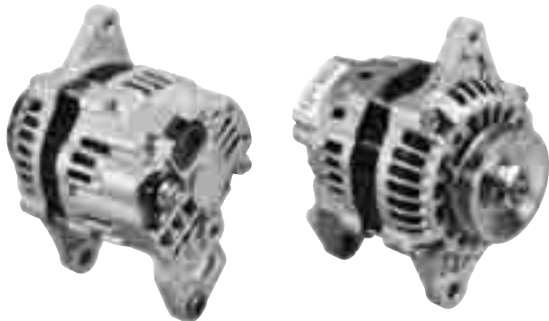

1-2062-01MI
(Ref# 12136N)

Alternator - Mitsubishi IR/IF
35 Amp/12 Volt, CW, 1-Groove Pulley

Used On: Nissan, TCM Lift Trucks w/ H20, H25 Engines
Replaces: Mitsubishi A7T03371, A7T03371A;
Nissan 23100-50K10
Lester Nos: 12136
Features: 100% New



1-2153-01MI
(Ref# 12311)

Alternator - Mando IR/IF
50 Amp/12 Volt, CW, 1-Groove Pulley

Used On: Caterpillar Lift Trucks GP15 w/ 4G63, 4G64 Engines
Replaces: Mitsubishi A2TA2871, A;
Mitsubishi Motors MD316418; MD354809, A
Lester Nos: 12311



1-2392-01MI
(Ref# 12231N)

Alternator - Mitsubishi IR/IF
40 Amp/12 Volt, CW, 1-Groove Pulley

Used On: Case Cub Cadet 7195, 7235, 7275 Tractor;
Toro Reelmaster 223D, 5100D Mower
Replaces: Mitsubishi AOT25371, MM435752; Toro 67-4630
Lester Nos: 12231
Features: 100% New



1-2438-01MI
(Ref# A6776N)

Alternator - Mitsubishi IR/IF
50 Amp/12 Volt, 1-Groove Pulley

Used On: Mazda HA, XA Diesel Engines
Replaces: Mazda SLR4-18-300;
Mitsubishi A2T36776, A2T38776
Features: 100% New



1-2479-01MI

Alternator - Mitsubishi IR/IF
65 Amp/12 Volt, 1-Groove Pulley

Used On: Mitsubishi Lift Trucks w/ 4G33, 4G52, 4G64 Engines
Replaces: Mitsubishi A3T03471,
Mitsubishi Motors MD169683, MD169683DD
Lester Nos: 12303



1-2480-01MI
(Ref# 12077N)

Alternator - Mitsubishi IR/IF
40 Amp/12 Volt, 1-Groove Pulley

Used On: New Holland Loader w/ N844, VSG413 Engines
Replaces: Ishikawajima 18504-6320, Mitsubishi A7T03877
Lester Nos: 12077
Note: With stator tap
Features: 100% New



2-1727-MI
(Ref# 16793)

Starter - Mitsubishi DD
0.9-1.1kW/12 Volt, CW, 8-Tooth Pinion

Used On: Mitsubishi Lift Trucks w/ 4G33, 4G52, 4G54, 4G64 Engines
Replaces: Clark 928805, 3790819; Mitsubishi M3T15971, M3T24917, M3T25981, M3T25981, M3T32681, M3T42881; Mitsubishi Motors MD189054, MM115514, MM115517; Towmotor 1017191; Yale 1500023-01, 9005408-56
Lester Nos: 16793

MITSUBISHI - STARTERS

DD (Direct Drive)



2-1554-MI-1
(Ref# 17291N)

Starter - Mitsubishi DD Replacement
12 Volt, CCW, 9-Tooth Pinion

Used On: Gehl, Mustang, New Holland Skid Loaders w/ Onan P-216, -218, -220, -224, -227 Engines
Replaces: Mitsubishi M2T43681, M2T43881, M2T32581, M2T43781; Onan 191-1808-06; 191-1949-04, -06, -07, -08
Lester Nos: 17291
Note: Replacement design
Features: 100% New

2-1554-MI

Starter - Mitsubishi DD Replacement

Note: Same as 2-1554-MI-1 except remanufactured



2-1728-MI
(Ref# 16924)

Starter - Mitsubishi DD
0.8kW/12 Volt, CW, 8-Tooth Pinion

Used On: Eaton, Hyster, Sumitomo Yale, TCM, Yale Lift Trucks w/ Mazda Engine
Replaces: Hyster 1362069, 3068345; Mazda FESE-18-400; Mitsubishi M3M10476, M3T10476D; Yale 1500023-05
Lester Nos: 16924
Note: 2-1728-MI-3 replaces early Mitsubishi starters w/ 11-tooth pinion: M3T10473, 475, 476 (WAI 2-2706-MI, Lester 16795)



2-1729-MI
(Ref# 16796)

Starter - Mitsubishi DD
0.8kW/12 Volt, CW, 9-Tooth Pinion

Used On: Eaton, Yale Lift Trucks
Replaces: Mitsubishi M3T11172, M3T11174; Yale 9005958-01
Lester Nos: 16796

HEAVY DUTY & OFF ROAD

HEAVY DUTY & OFF ROAD

MITSUBISHI - STARTERS

DD (Direct Drive (cont'd))



2-1738-MI-1
(Ref# 17332)

Starter - Mitsubishi DD Replacement
12 Volt, CCW, 9-Tooth Pinion

Used On: Onan Engines CCK, CCKA, CCKB, NH, NHA, NHA V, NHB, NHBV, NHC, NHCZ, NHP, NHPV

Replaces: Mitsubishi MEA10-7; Onan 191-1052, 191-1682-03, 191-1808-03, 191-1949-03

Lester Nos: 17332

Note: Replacement design



2-1740-MI
(Ref# 16794)

Starter - Mitsubishi DD
0.8kW/12 Volt, CW, 8-Tooth Pinion

Used On: Nissan Lift Trucks, TCM Lift Trucks w/ A15, H20, J15, Z24 Engines

Replaces: Mitsubishi M3T21881, 882, 882D; M3T25181, M3T38682; Nissan 23300-00H10, -L1110, -L1111, -L2911, -P0614

Lester Nos: 16794



2-1741-1
(Ref# 16210-9T)

Starter - Mitsubishi DD Replacement
0.8kW/12 Volt, CW, 9-Tooth Pinion

Used On: Nissan Lift Trucks, TCM Lift Trucks w/ H20, J15 Engines

Replaces: Hitachi S114-71, -91; Mitsubishi M3T11272, MEA13-1, MEY2R, MEY3R; Nissan 23300-15800, -15815, -P5111

Lester Nos: 16201, 16210

Note: Replacement design



2-2088-MI
(Ref# 16798)

Starter - Mitsubishi DD
0.8kW/12 Volt, CW, 8-Tooth Pinion

Used On: Sumitomo Yale, Yale Lift Trucks w/ Mazda D5 Engine

Replaces: Mazda 4780-18-400, A; Mitsubishi M3T30981

Lester Nos: 16798



2-2089-MI

Starter - Mitsubishi DD
1.2kW/12 Volt, CW, 9-Tooth Pinion

Used On: Mitsubishi Tractor w/ 2-Cyl. Diesel Engine

Replaces: Mitsubishi M4T14674, MM401600

Lester Nos: 18097

Features: 100% New, mfd. in Japan to OE specifications



2-2706-MI
(Ref# 16795)

Starter - Mitsubishi DD
0.8kW/12 Volt, 11-Tooth Pinion

Used On: Eaton, Hyster, Sumitomo Yale, TCM, Yale Lift Trucks w/ Mazda Engine

Replaces: Hyster 3003784, 3021367, 326875, 388040; Mazda 4893-18-400B, D, E; Mitsubishi M3T10473, M3T10475, M3T10476; Yale 2200709-79, 9005408-49, 9005408-57, 9129786-00

Lester Nos: 16795

OSGR (Offset Gear Reduction)



2-1254-MI-2
(Ref# 17037N)

Starter - Mitsubishi OSGR
12 Volt, CW, 13-Tooth Pinion

Used On: (1987-85) Ford E, F Series Van, Pickup 6.9L (Diesel)
(1994-88) Ford E, F Series Van, Pickup 7.3L (Diesel)
(cont'd)

(cont'd)

Replaces: Ford E8TF-11000-AA, E8TZ-11002-A;
Mitsubishi M3T90071, M3T90072

Lester Nos: 17037

Note: Interchangeable with 2-1726-ND, 2-1747-MI, 50-8420-1,
50-8437-1 (Lester Nos. 6573, 16658, 17577)

Features: 100% New

FORD PICKUPS, VANS 6.9L, 7.3L DIESEL ENGINES

| | Catalog No. | Design | Teeth | Replaces | Lester |
|---|--|--------|-------|--------------------------------------|--------|
|  | (1994-85) 6.9L, 7.3L IDI Diesel (Indirect Injected) | | | | |
| | A full range of interchangeable starters. Although 2-1254-MI-2, 2-1726-ND-2, 2-1747-MI, 50-8420 have a different number of pinion teeth, they are interchangeable because of the location of the pinion to the mounting flange bolt holes. | | | | |
| | 2-1254-MI-2 | OSGR | 13 | Mitsubishi M3T90071, 072 | 17037 |
|  | 2-1726-ND-2 | OSGR | 13 | Nippondenso 028000-588 | 16658 |
|  | 2-1747-MI | PLGR | 12 | Mitsubishi M8T50171 | 17577 |
|  | 50-8420 | 28MT | 10 | Delco 1113276, 292 | 6573 |
|  | (2000-94) 7.3L DI Diesel (Direct Injected Powerstroke) | | | | |
| | 2-1748-MI-1 | PLGR | 12 | Mitsubishi M8T50071 | 17578 |
|  | (2003-01) 7.3L DI Diesel (Direct Injected Powerstroke) | | | | |
| | 2-2197-FD-2 | OSGR | 12 | Ford 2C3T-11000-AA, 2C3Z-11002-AA | 6669 |

HEAVY DUTY & OFF ROAD

HEAVY DUTY & OFF ROAD

MITSUBISHI - STARTERS

OSGR (Offset Gear Reduction) (cont'd)



2-1612-MI
(Ref# 17110N)

Starter - Mitsubishi OSGR
1.2kW/12 Volt, CW, 11-Tooth Pinion

Used On: Clark, Mitsubishi Lift Trucks w/ 4G33, 4G52, 4G54, 6G72 Engines

Replaces: Clark 918306, 4314765; Mitsubishi M2T58581, M2T58881; Mitsubishi Motors MD171228, MM115518

Lester Nos: 17110

Features: 100% New

2-1612-MI-2
(Ref# 17110)

Starter - Mitsubishi OSGR

Note: Same as 2-1612-MI except remanufactured



2-1732-MI-1
(Ref# 17008N)

Starter - Mitsubishi OSGR
2.0kW/12 Volt, CW, 10-Tooth Pinion

Used On: Hydra-Mac, Onan DL3, L317D, L423, L634, MDL3, MDL4 Engines

Replaces: Mitsubishi M2T56071, M2T56072; Onan 191-1394, 191-1888, 191-1959

Lester Nos: 17008

Features: 100% New



2-1733-MI
(Ref# 16935)

Starter - Mitsubishi OSGR
1.4kW/12 Volt, CW, 11-Tooth Pinion

Used On: Nissan Lift Trucks, TCM Lift Trucks

Replaces: Mitsubishi M2T58381; Nissan 23300-20H00, -20H12

Lester Nos: 16935

Features: 100% New



2-1780-MI
(Ref# 17244)

Starter - Mitsubishi OSGR
1.6kW/12 Volt, CW, 11-Tooth Pinion

Used On: Ford Tractor, Gehl, Ishikawajima-Shibaura, New Holland, Perkins Engines

Replaces: Ford SBA-18508-6410, SBA-18508-6500; Ishikawajima-Shibaura 185086410, 185086510, 185086560; Mitsubishi M2T54085, M2T54091, M2T58981

Lester Nos: 17244

Note: For late style, 12-tooth PLGR starter use 2-2086-MI (Lester 18238)



2-1781-MI

Starter - Mitsubishi OSGR
2.0kW/12 Volt, CW, 13-Tooth Pinion

Used On: Clark Lift Truck; Toro Equipment w/ K3D, K4D, K4E Mitsubishi Engines

Replaces: Clark 807950, 911410; Mitsubishi M2T56272, MM409413

Lester Nos: 17096

Features: 100% New, mfd. in Japan to OE specifications



2-1913-MI-1
(Ref# 18242N)

Starter - Mitsubishi OSGR Replacement
4.5kW/24 Volt, CW, 11-Tooth Pinion

Used On: Mitsubishi Fuso Trucks w/ 6D10, 6D15 Engines
Replaces: Mitsubishi M3T56071, M3T56072, M3T56082, ME037465, ME037636, ME077407
Lester Nos: 18242
Features: 100% New, Nippondenso style replacement



2-1963-MI
(Ref# 17081N)

Starter - Mitsubishi OSGR
2.0kW/12 Volt, CW, 11-Tooth Pinion

Used On: Case Trencher; Toro Reelmaster 450D, 4500D Mowers
Replaces: Mitsubishi 34466-03200, 34466-15202, 34466-20200, 34766-41300, M2T56471, M2T56472, M2T61371, M3T64172
Lester Nos: 17081
Features: 100% New



2-2024-MI
(Ref# 18171N)

Starter - Mitsubishi OSGR
2.7kW/12 Volt, CW, 13-Tooth Pinion

Used On: Hyster, Sumitomo Yale, Yale Lift Trucks w/ Mazda HA, XA Engines
Replaces: Hyster 2021166, 3068346 ; Mazda 4840-18-400, A, B; Mitsubishi M2T54571, M2T54572; Yale 1500225-14, 9010988-90, 9010988-91
Lester Nos: 18171
Features: 100% New



2-2087-MI-1

Starter - Mitsubishi OSGR
5.0kW/24 Volt, CW, 10-Tooth Pinion

Used On: Caterpillar, Mitsubishi Lift Trucks w/ S4E, S4S, S6E, S6S Engines
Replaces: Caterpillar 114-6864; Mitsubishi 34366-00101, 34766-10903, 34766-20900, M3T56172, M3T56174, M3T56181, M3T56182, M3T56183
Lester Nos: 18239
Features: 100% New

2-2087-MI
(Ref# 18239N)

Starter - Mitsubishi OSGR

Note: Same as 2-2087-MI-1 except mfd. by OE supplier



2-2091-MI

Starter - Mitsubishi OSGR
6.0kW/24 Volt, CW, 13-Tooth Pinion

Used On: Kobelco, Mitsubishi Industrial
Replaces: Mitsubishi 30966-03010, M5T50276
Features: 100% New, mfd. in Japan to OE specifications



2-2092-MI

Starter - Mitsubishi OSGR
5.0kW/24 Volt, CW, 11-Tooth Pinion

Used On: Mitsubishi Backhoe
Replaces: Mitsubishi M3T56076, M5T50176, ME039950, ME049182
Features: 100% New, mfd. in Japan to OE specifications

HEAVY DUTY & OFF ROAD

HEAVY DUTY & OFF ROAD

MITSUBISHI - STARTERS

OSGR (Offset Gear Reduction) (cont'd)

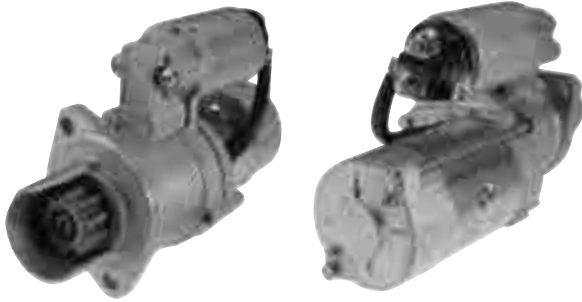

2-2093-MI
(Ref# 18168N)

Starter - Mitsubishi OSGR
12 Volt, CCW, 10-Tooth Pinion

Used On: Power Generators w/ Onan DJC, RDJC, RDJF Engines

Replaces: Mitsubishi M2T55971, Onan 191-1399

Lester Nos: 18168

Features: 100% New



2-2094-MI

Starter - Mitsubishi OSGR
3.5kW/12 Volt, CW, 13-Tooth Pinion

Used On: Mitsubishi-Fuso Trucks

Replaces: Mitsubishi M3T90272, ME087577

Features: 100% New, mfd. in Japan to OE specifications



2-2101-MI
(Ref# 18287N)

Starter - Mitsubishi OSGR
3.2kW/24 Volt, CW, 10-Tooth Pinion

Used On: Nissan Bus w/ ED33 Diesel Engine

Replaces: Mitsubishi M2T64371, M2T64372, M2T64373; Nissan 23300-T9005, -T9006, -T9007

Lester Nos: 18287

Features: 100% New



2-2102-MI
(Ref# 18163N)

Starter - Mitsubishi OSGR
2.2kW/12 Volt, CW, 10-Tooth Pinion

Used On: Mitsubishi Lift Trucks w/ S4E, S4S Diesel Engines

Replaces: Caterpillar 103-9827, Clark 920670;

Mitsubishi 32A66-00100, 32A66-00101, M2T62271, M2T62272

Lester Nos: 18163

Features: 100% New



2-2103-MI

(Ref# 18245N-7)

Starter - Mitsubishi OSGR
3.2kW/24 Volt, CW, 11-Tooth Pinion

Used On: Mitsubishi Lift Trucks w/ S4E, S4S Diesel Engines

Replaces: Clark 3785426, 37909; Mitsubishi 34466-03101,

34466-10103, 34466-15102, 34466-20102, M2T65271,

M2T65272, M2T65275, M3T54072

Lester Nos: 18245

Features: 100% New



2-2220-MI

(Ref# 16873N)

Starter - Mitsubishi OSGR
3.2kW/24 Volt, CW, 9-Tooth Pinion

Used On: Caterpillar Excavator w/ Mitsubishi Engine

Replaces: Caterpillar 8S9096, Mitsubishi M2T64272, MEO17004

Lester Nos: 16873

Features: 100% New



2-2227-MI
(Ref# 17244N)

Starter - Mitsubishi OSGR
2.2kW/12 Volt, CW, 13-Tooth Pinion

Used On: Ford Tractor, Gehl, Ishikawajima-Shibaura, New Holland, Perkins Engines
Replaces: Ford SBA-18508-6410, SBA-18508-6500; Ishikawajima-Shibaura 185086410, 185086510, 185086560; Mitsubishi M2T54085, M2T54091, M2T63371
Lester Nos: 17244
Note: For late style, 12-tooth PLGR starter use 2-2086-MI (Lester 18238)
Features: 100% New



2-2229-MI
(Ref# 18241N)

Starter - Mitsubishi OSGR
3.2kW/24 Volt, CW, 9-Tooth Pinion

Used On: Mitsubishi Fuso Canter Trucks FB, FE Series w/ 4D30, 4DR5 Diesel Engines
Replaces: Mitsubishi M2T67871, M2T67881, ME017035, ME017085
Lester Nos: 18241
Features: 100% New



2-2227-MI-2
(Ref# S6037N)

Starter - Mitsubishi OSGR
2.2kW/12 Volt, CW, 12-Tooth Pinion

Used On: Ford Tractor, Gehl, Ishikawajima-Shibaura, New Holland, Perkins Engines
Replaces: Ford SBA-18508-6410, SBA-18508-6500; Ishikawajima-Shibaura 185086410, 185086510, 185086560; Mitsubishi M2T54085, M2T54091, M2T63371
Lester Nos: 17244
Note: For late style, 12-tooth PLGR starter use 2-2086-MI (Lester 18238)
Features: 100% New



2-2652-MI
(Ref# 65971N)

Starter - Mitsubishi OSGR
24 Volt, CCW, 10-Tooth Pinion

Used On: Onan
Replaces: Mitsubishi M2T65971; Onan 191-1618
Lester Nos: 19606
Features: 100% New

PLGR (Planetary Gear Reduction)



2-2228-MI
(Ref# 18240N)

Starter - Mitsubishi OSGR
2.0kW/12 Volt, CW, 9-Tooth Pinion

Used On: Mitsubishi Fuso Canter Trucks 4DR7
Replaces: Mitsubishi M2T61771, ME001565
Lester Nos: 18240
Features: 100% New



2-1747-MI
(Ref# 17577N)

Starter - Mitsubishi PLGR
12 Volt, CW, 12-Tooth Pinion

Used On: (1994) Ford E, F Series Van, Pickup 7.3L (Diesel) exc. Power Stroke
Replaces: Ford F4TZ-11002-B, Mitsubishi M8T50171
Lester Nos: 17577
Note: Interchangeable with 2-1254-MI, 2-1726-ND, 50-8420-1, 50-8437-1 (Lester Nos. 6573, 16658, 17037)
Features: 100% New

HEAVY DUTY & OFF ROAD

HEAVY DUTY & OFF ROAD

MITSUBISHI - STARTERS

PLGR (Planetary Gear Reduction) (cont'd)

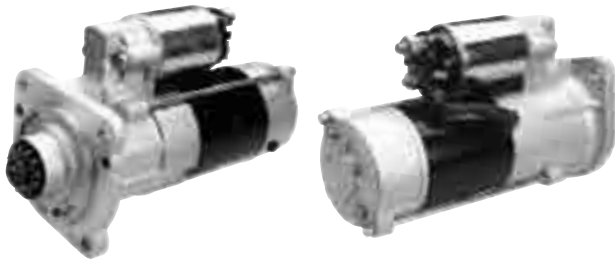

2-1748-MI-1
(Ref# 17578N)

Starter - Mitsubishi PLGR
12 Volt, CW, 12-Tooth Pinion

Used On: (2000) Ford Excursion 7.3L (Power Stroke Diesel)
(2000-95) Ford E Series Van 7.3L (Power Stroke Diesel)
(2000-94) Ford F Series Pickup 7.3L (Power Stroke Diesel)
Replaces: Ford F4TZ-11002-A; F5TU-11000-AA, -AB;
Mitsubishi M8T50071
Lester Nos: 17578
Features: 100% New



2-2086-MI

Starter - Mitsubishi PLGR
2.0kW/12 Volt, CW, 12-Tooth Pinion

Used On: Ishikawajima-Shibaura, Perkins Engines
Replaces: Ishikawajima-Shibaura 185086560,
Mitsubishi M8T70071
Lester Nos: 18238
Note: 2-2086-MI is late style, 12-tooth PLGR design replacing
early 11-tooth & 12-tooth OSGR design 2-1780-MI, 2-2227-MI-2
(Lester 17244)
Features: 100% New, mfd. in Japan to OE Specifications

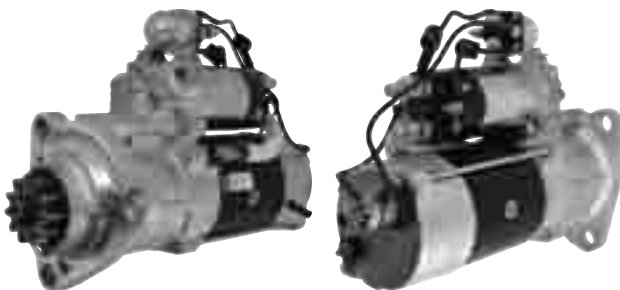

2-2824-MI

Starter - Mitsubishi PLGR
7.5kW/24 Volt, CW, 11-Tooth Pinion

Used On: Prevost Bus w/ Detroit Diesel Engines
Replaces: Mitsubishi M9T82479, Prevost 510751
Lester Nos: 19535
Features: 100% New

PMGR (Perm. Magnet Gear Reduction)

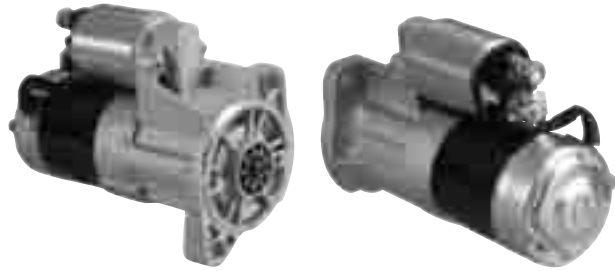

2-1444-MI

(Ref# 17437N)

Starter - Mitsubishi PMGR
1.2kW/12 Volt, CW, 9-Tooth Pinion

Used On: Nissan Lift Trucks, TMC Lift Trucks
Replaces: Mitsubishi M1T60081, M1T60381;
Nissan 23300-K9160, 23300-W9810
Lester Nos: 17437
Features: 100% New

2-1444-MI-9

(Ref# 17437)

Starter - Mitsubishi PMGR

Note: Same as 2-1444-MI except remanufactured



2-1728-MI-3

(Ref# 18096N)

Starter - Mitsubishi PMGR
1.2kW/12 Volt, CW, 8-Tooth Pinion

Used On: Eaton, Hyster, Sumitomo Yale, TCM, Yale Lift Trucks
w/ Mazda Engine
Replaces: Hyster 1362069, 2314322, 3068345, 3114995;
Mazda FESE-18-400, FFSC-18-400, FFSO-18-400;
Mitsubishi MOT84381, M3M10476, M3T10476D;
Yale 1500023-05, 9181396-00
Lester Nos: 18096
Note: 2-1728-MI-3 replaces early Mitsubishi starters w/ 11-tooth
pinion: M3T10473, 475, 476 (WAI 2-2706-MI, Lester 16795)
Features: 100% New



2-1996-MI

(Ref# 17176N)

Starter - Mitsubishi PMGR
1.2kW/12 Volt, CW, 10-Tooth Pinion

(cont'd)

(cont'd)

Used On: Caterpillar, Clark, Mitsubishi Lift Trucks w/ 4G63, 4G64, 6G72 Engines

Replaces: Clark 920971, 921615; Mitsubishi M1T79681, M1T79781; Mitsubishi Motors MD318086, MD320618

Lester Nos: 17176

Features: 100% New



2-2569-MI
(Ref# 18395N)

Starter - Mitsubishi PMGR
1.7kW/12 Volt, CW, 9-Tooth Pinion

Used On: Ford New Holland, Ishikawajima, Kubota, Perkins

Replaces: Ford SBA-18508-6550, SBA-18508-6551; Ishikawajima 18508-6550, 18508-6551; Mitsubishi M1T66081

Lester Nos: 18395

Features: 100% New



2-2638

Starter - Mitsubishi PMGR
1.7kW/12 Volt, CW, 12-Tooth Pinion

Used On: Toro Ag Equipment w/ Peugeot Diesel Citroen, Peugeot Diesel (Europe)

Replaces: Mitsubishi M1T80081, M1T80082, M1T90281; Peugeot-Citroen 5802E2, 5802Q5

Lester Nos: 18967

Features: 100% New



2-2697-MI

Starter - Mitsubishi PMGR
1.7/12 Volt, CW, 10-Tooth Pinion

Used On: (2007-05) Dodge Ram Pickup 5.7L w/ AT

Replaces: Chrysler 4801253AA; Mitsubishi M0T21371

Lester Nos: 17933

Features: 100% New



2-2698-MI

(Ref# 65381N)

Starter - Mitsubishi PMGR
12 Volt, CW, 9-Tooth Pinion

Used On: Nissan Lift Trucks

Replaces: Mitsubishi M0T65381, Nissan 23300-FU410

Features: 100% New

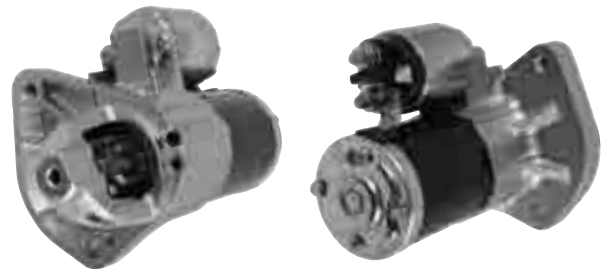

2-2725-MI

(Ref# 17932)

Starter - Mitsubishi PMGR
1.7/12 Volt, CW, 10-Tooth Pinion

Used On: (2007-05) Dodge Ram Pickup 5.7L w/ MT

Replaces: Chrysler 56029274AA; Mitsubishi M0T21271

Lester Nos: 17932

Features: 100% New

NIKKO - STARTERS



2-1951-NK-1

(Ref# 18100N)

Starter - Nikko OSGR Replacement
4.5kW/24 Volt, CW, 11-Tooth Pinion

Used On: Link-Belt, Hitachi Excavator w/ Isuzu 6BD1, 6BG1 Engines

Replaces: Isuzu 1-81100-189-0, -1; 1-81100-191-0; 1-81100-253-0, -1; 1-81100-259-0; 5-81100-174-0, -2;

Nikko 0-23000-1020, -1030, -1031, -1032, -1033, -1070, -1071

Lester Nos: 18100

Features: 100% New, Nippondenso style replacement

HEAVY DUTY & OFF ROAD

HEAVY DUTY & OFF ROAD

NIKKO - STARTERS (cont'd)



2-2729-NK-2
(Ref# 18084N)

Starter - Nikko OSGR

7.5kW/24 Volt, CW, 12-Pinion Teeth

Used On: Komatsu Crawlers, Generators, Graders w/ 6D105, 6D125, 6D140 Engines

Replaces: Komatsu 600-813-4530, 600-813-4531, 600-813-4532, 600-813-4533; Nikko 0-23000-3150, 0-23000-3151, 0-23000-3152, 0-23000-3153

Lester Nos: 18084

Features: 100% New



2-2730-NK-2
(Ref# 18087N)

Starter - Nikko OSGR

7.5kW/24 Volt, CW, 12-Pinion Teeth

Used On: Komatsu Crawlers, Generators, Graders, Lift Trucks w/ 6D105, 6D125 Engines

Replaces: Komatsu 600-813-3530; Nikko 0-23000-6250, 0-23000-6251

Lester Nos: 18087

Features: 100% New



2-2731-NK-2
(Ref# 18107N)

Starter - Nikko OSGR Replacement
7.5kW/24 Volt, CW, 12-Pinion Teeth

Used On: Komatsu Excavators, Graders w/ 6D105, 6D125 Engines

Replaces: Komatsu 600-813-3630, 600-813-3631; Nikko 0-23000-6530, -6531, -6532, -6533

Lester Nos: 18107

Features: 100% New, Nippondenso style replacement



2-2770-NK

Starter - Nikko OSGR

4.0kW/24 Volt, CW, 9-Tooth Pinion

Used On: Mercedes Atego Trucks (Europe)

Replaces: Bosch 0-001-231-002, 0-001-231-033;

Delco 10479626, 10479650, 19070039;

Mercedes 004-151-84-01, 005-151-20-01, 006-151-22-01, 006-151-22-03;

Nikko 0-23000-2350, 0-23000-2358, 0-23000-2590

Lester Nos: 6605, 18364

Features: 100% New



photo not available

2-2828-NK

Starter - Nikko DD

5.5kW/24 Volt, CW, 13-Tooth Pinion

Used On: Komatsu Crawlers w/ 4D105 Engines

Replaces: Komatsu 600-813-2241, -2242, -2250;

Nikko 0-21000-4190, 0-21000-4191, 0-21000-4192

Lester Nos: 18076

Features: 100% New

NIPPONDENSO - ALTERNATORS

ER/EF (Ext. Reg./Ext. Fan)



1-2461-01ND

Alternator - Nippondenso ER/EF

25 Amp/12 Volt, CW, 1-Groove Pulley

Used On: John Deere Farm Tractors w/ Yanmar 3T80J, 3T90J, 3T90TJ Diesel Engines

Replaces: John Deere CH10493, TY6647;

Nippondenso 021000-728, 5702100-728

Lester Nos: 14519



1-2840-01ND-2
(Ref# A980N)

Alternator - Universal ER/EF
35 Amp/12 Volt, 1-Groove Pulley

Features: 100% New, external regulated
Threaded tension ear

ER/IF (Ext. Reg./Int. Fan)



1-1503-06ND-2

Alternator - Nippondenso ER/IF
90 Amp/12 Volt, CW, 7-Groove/58mm Dia. Pulley

Used On: (1998-97) Dodge B Series Van 3.9L, 5.2L, 5.9L
(1998-97) Dodge Dakota 3.9L, 5.2L
(1998) Dodge Dakota 5.9L
(1998) Dodge Durango 5.2L, 5.9L

(1998-97) Dodge Ram Pickup 3.9L, 5.2L, 5.9L, 8.0L

Replaces: Chrysler 56007912, Nippondenso 121000-353

Lester Nos: 13354

Features: 100% New

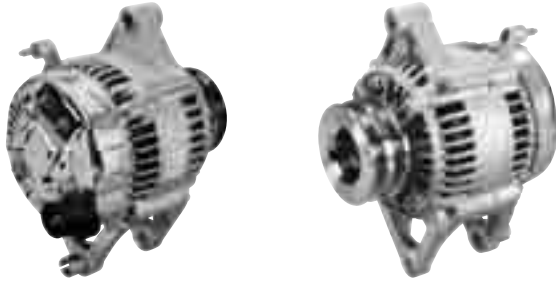

1-1503-01ND-2
(Ref# 13312N)

Alternator - Nippondenso ER/IF
90 Amp/12 Volt, CW, 2-Groove Pulley

Used On: (1992-90) Dodge B Series Van 3.9L, 5.2L, 5.9L
(1992-90) Dodge D Series Pickup 3.9L, 5.2L, 5.9L
(1991-90) Dodge Dakota 3.9L, 5.2L
(1992-90) Dodge Ramcharger 5.2L, 5.9L
(1992-90) Dodge W Series Pickup 3.9L, 5.2L, 5.9L

Replaces: Chrysler 5234028, Nippondenso 121000-337

Lester Nos: 13312

Features: 100% New



1-1504-01ND-2

Alternator - Nippondenso ER/IF
120 Amp/12 Volt, CW, 2-Groove Pulley

Used On: (1992-90) Dodge B Series Van 3.9L, 5.2L, 5.9L
(1992-90) Dodge D Series Pickup 3.9L, 5.2L, 5.9L
(1991-90) Dodge Dakota 3.9L

(1992-90) Dodge Ramcharger 5.2L, 5.9L

(1992-90) Dodge W Series Pickup 3.9L, 5.2L, 5.9L

Replaces: Chrysler 5234199, Nippondenso 121000-404

Lester Nos: 13301

Features: 100% New



1-1503-05ND-2

Alternator - Nippondenso ER/IF
90 Amp/12 Volt, CW, 7-Groove/65mm Dia. Pulley

Used On: (1996-92) Dodge B Series Van 3.9L, 5.2L, 5.9L
(1993-92) Dodge D Series Pickup 3.9L, 5.2L, 5.9L
(1996-92) Dodge Dakota 3.9L, 5.2L
(1996-94) Dodge Ram Pickup 3.9L, 5.2L, 5.9L
(1993-92) Dodge Ramcharger 5.2L, 5.9L
(1993-92) Dodge W Series Pickup 3.9L, 5.2L, 5.9L

Replaces: Chrysler 53008647, Nippondenso 121000-347

Lester Nos: 13354

Features: 100% New



1-1504-05ND-2

Alternator - Nippondenso ER/IF
120 Amp/12 Volt, CW, 8-Groove Pulley

Used On: (1993-90) Dodge D Series Pickup 5.9L Diesel
(1998-94) Dodge Ram Pickup 5.9L Diesel

(1993-90) Dodge W Series Pickup 5.9L Diesel

Replaces: Chrysler 5234374, 56027221;

Nippondenso 121000-408, 121000-415

Lester Nos: 13302

Features: 100% New

NIPPONDENSO - ALTERNATORS

ER/IF (Ext. Reg./Int. Fan) (cont'd)



1-1504-06ND-2

Alternator - Nippondenso ER/IF

120 Amp/12 Volt, CW, 7-Groove/65mm OD Pulley

Used On: (1996-92) Dodge B Series Van 3.9, 5.2, 5.9L

(1993-92) Dodge D Series Pickup 3.9, 5.2, 5.9L

(1996-91) Dodge Dakota 3.9, 5.2L

(1996-94) Dodge Ram Pickup 3.9, 5.2, 5.9, 8.0L

(1993-92) Dodge Ramcharger 5.2, 5.9L

(1993-92) Dodge W Series Pickup 3.9, 5.2, 5.9L

Replaces: Chrysler 53008651, Nippondenso 121000-413

Lester Nos: 13453

Features: 100% New



1-1527-02ND-2

Alternator - Nippondenso ER/IF

75 Amp/12 Volt, CW, 7-Groove Pulley

Used On: (1996-92) Dodge B Series Van 3.9L, 5.2L, 5.9L

(1993-92) Dodge D Series Pickup 3.9L, 5.2L, 5.9L

(1996-92) Dodge Dakota 3.9L, 5.2L

(1996-94) Dodge Ram Pickup 3.9L, 5.2L, 5.9L

(1993-92) Dodge Ramcharger 5.2L, 5.9L

(1993-92) Dodge W Series Pickup 3.9L, 5.2L, 5.9L

Replaces: Chrysler 53008646, Nippondenso 121000-346

Lester Nos: 13353

Features: 100% New



1-2087-01ND-2

Alternator - Nippondenso ER/IF

136 Amp/12 Volt, CW, 7-Groove Pulley

Used On: (1998-97) Dodge B Series Van, Dakota 3.9L, 5.2L, 5.9L

(cont'd)

(cont'd)

(1998) Dodge Durango 5.2L, 5.9L

(1998-97) Dodge Ram Pickup 3.9L, 5.2L, 5.9L, 8.0L

Replaces: Chrysler 56027913, Nippondenso 121000-417

Lester Nos: 13742

Features: 100% New



1-2225-01ND-2

(Ref# 13823N)

Alternator - Nippondenso ER/IF

117 Amp/12 Volt, CW, 7-Groove Pulley

Used On: (2000-99) Dodge B Series Van 3.9L, 5.2L, 5.9L

(2000-99) Dodge Dakota 3.9L, 5.2L, 5.9L

(2000-99) Dodge Durango 3.9L, 5.2L, 5.9L

(2001-99) Dodge Ram Pickup 3.9L, 5.2L, 5.9L, 8.0L

Replaces: Chrysler 56027912AB, Nippondenso 121000-363

Lester Nos: 13823

Note: For Bosch design use 1-2225-01BO (Lester 13843).

For 136A Nippondenso design use 1-2227-02ND-2 (Lester 13824).

Features: 100% New

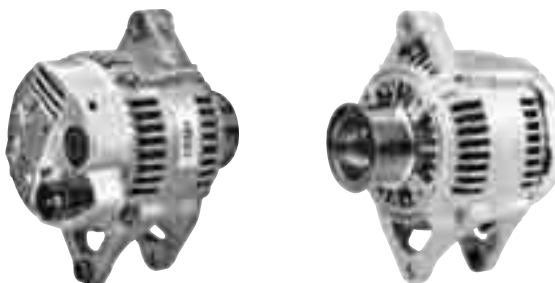

1-2227-01ND

(Ref# 13766N)

Alternator - Nippondenso ER/IF

136 Amp/12 Volt, CW, 8-Groove Pulley

Used On: (2001-99) Dodge Ram Pickup 5.9L Diesel

Replaces: Chrysler 56027221AB, Nippondenso 121000-428

Lester Nos: 13766

Note: Also replaces Bosch 0-124-525-005, 6-004-ML0-004; Chrysler 56028239AB (Lester 13881) Alternators.

Features: 100% New

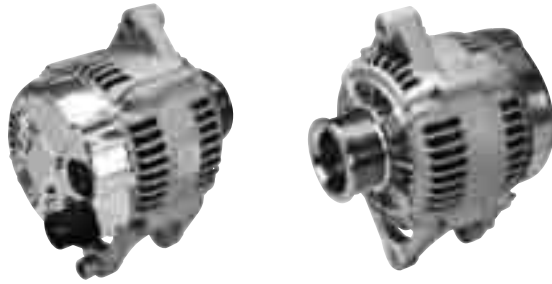

1-2227-02ND-2
(Ref# 13824N)

Alternator - Nippondenso ER/IF
136 Amp/12 Volt, CW, 7-Groove Pulley

Used On: (2000-99) Dodge Ram Van 3.9L, 5.2L, 5.9L
(2000-99) Dodge Dakota, Durango 3.9L, 5.2L, 5.9L
(2001-99) Dodge Ram Pickup 3.9L, 5.2L, 5.9L, 8.0L
Replaces: Chrysler 56027913AB, AC; 56028920AA;
Nippondenso 121000-429, -435
Lester Nos: 13824
Dim: M6 x 1.0 Batt. Term.
Features: 100% New



1-2389-01ND-2
(Ref# 13874N)

Alternator - Nippondenso ER/IF
136 Amp/12 Volt, CW, 8-Groove Pulley

Used On: (2002) Dodge Ram Pickup 5.9L
Replaces: Chrysler 56027221AD, Nippondenso 121000-448
Lester Nos: 13874
Features: 100% New



1-2390-01ND
(Ref# 13911N)

Alternator - Nippondenso ER/IF
136 Amp/12 Volt, CW, 7-Groove Pulley

Used On: (2003-01) Dodge B Series Van 3.9L, 5.2L, 5.9L
(2003-01) Dodge Dakota 3.9L, 5.9L
(2000) Dodge Ram Pickup 5.2L, 5.9L, 8.0L
Replaces: Chrysler 56028920AB, 56030914AB;
Nippondenso 121000-445, 121000-447
Lester Nos: 13911
Features: 100% New



1-2441-01ND
Alternator - Nippondenso ER/IF
136 Amp/12 Volt, CW, 6-Groove Pulley

Used On: (2007-02) Dodge Durango 4.7L
(2003-02) Dodge Ram Pickup 3.7L, 4.7L
Replaces: Chrysler 56029700AA, AB, AC;
Nippondenso 421000-010
Lester Nos: 13912

IR/EF (Int. Reg./Ext. Fan)



1-2236-10ND
Alternator - Nippondenso IR/EF
90 Amp/12 Volt, CW, wo/ pulley

Used On: John Deere Equipment 4840, 8430
Replaces: John Deere AR87204, 05; AR93447, 48; AT103789,
TY6621; Nippondenso 100211-007, -008, -028, -029;
9700211-029
Lester Nos: 13143
Features: 100% New

IR/IF (Int. Reg./Int. Fan)



1-1946-01ND
(Ref# 12182)
Alternator - Nippondenso IR/IF
40 Amp/12 Volt, 1-Groove Pulley

Used On: Toyota Lift Truck w/ 1Z, 2J, 3F Engines
Replaces: Nippondenso 100211-400, Toyota 27060-78301-71
Lester Nos: 12182
Features: 100% New

HEAVY DUTY & OFF ROAD

HEAVY DUTY & OFF ROAD

NIPPONDENSO - ALTERNATORS

IR/IF (Int. Reg./Int. Fan) (cont'd)



1-2119-11ND

(Ref# 12180N-7)

**Alternator - Nippondenso IR/IF
45 Amp/12 Volt, CW, 1-Groove Pulley**

Used On: Toyota Lift Trucks 4P, 4Y, V1502 Engines
Replaces: Hyster 3049491, Nippondenso 100211-166, Toyota 27060-78001-71
Lester Nos: 12180
Features: 100% New

1-2119-11ND-9

(Ref# 12180)

Alternator - Nippondenso IR/IF

Note: Same as 1-2119-11ND except remanufactured



1-2132-01ND-2

(Ref# 12187N-7)

**Alternator - Nippondenso IR/IF
35 Amp/12 Volt, CW, 1-Groove Pulley**

Used On: Toyota Lift Trucks 4P, 4Y, 5K, V1512 Engines
Replaces: Nippondenso 100211-454, Toyota 27060-78003-71
Lester Nos: 12187
Features: 100% New

1-2132-01ND

(Ref# 12187)

Alternator - Nippondenso IR/IF

Note: Same as 1-2132-01ND-2 except remanufactured



1-2336-01ND

(Ref# 12190N)

**Alternator - Nippondenso IR/IF
30 Amp/12 Volt, CW, 1-Groove Pulley**

Used On: Kubota Tractors, Industrial Equipment w/ Kubota D1005 3-Cyl. Diesel Engine
Replaces: Kubota 16231-64011, -64012; Nippondenso 100211-452
Lester Nos: 12190
Features: 100% New

1-2336-01ND-9

(Ref# 12190)

Alternator - Nippondenso IR/IF

Note: Same as 1-2336-01ND except remanufactured



1-2436-01ND

(Ref# 12189N)

**Alternator - Nippondenso IR/IF
40 Amp/12 Volt, 1-Groove Pulley**

Used On: Kubota A28 Engine, Thermo King UMD
Replaces: Kubota 15881-64200, -64201; Nippondenso 100211-163
Lester Nos: 12189
Features: 100% New



1-2439-01ND

(Ref# 12184N)

**Alternator - Nippondenso IR/IF
55 Amp/12 Volt, 1-Groove Pulley**

(cont'd)

(cont'd)

Used On: Toyota Lift Trucks w/ 1DZ, 1Z, 2DZ, 3F, 11Z Engines
Replaces: Nippondenso 100211-693, Toyota 27060-78305-71
Lester Nos: 12184
Features: 100% New



1-2456-01ND
 (Ref# 31260N)

Alternator - Nippondenso IR/IF
55 Amp/12 Volt, CW, 2-Groove Pulley

Used On: Toyota Industrial Diesel Engines
Replaces: Nippondenso 100213-126, Toyota 27040-64150
Features: 100% New



1-2476-01ND
 (Ref# 12179N)

Alternator - Nippondenso IR/IF
40 Amp/12 Volt, 1-Groove Pulley

Used On: Kubota V1200 Diesel Engine
Replaces: Kubota 16241-64011, Nippondenso 100211-167
Lester Nos: 12179
Features: 100% New



1-2477-01ND
 (Ref# 12198N)

Alternator - Nippondenso IR/IF
40 Amp/12 Volt, 1-Groove Pulley

Used On: Kubota
Replaces: Kubota 16705-64011, Nippondenso 100211-464
Lester Nos: 12198
Features: 100% New



1-2478-01ND
 (Ref# 12199N)

Alternator - Nippondenso IR/IF
40 Amp/12 Volt, 1-Groove Pulley

Used On: Kubota Farm, Utility Tractors
Replaces: Kubota 34070-75601, -75602;
 Nippondenso 100211-465
Lester Nos: 12199
Features: 100% New



1-2821-01ND-2
 (Ref# 12185N)

Alternator - Nippondenso IR/IF
50 Amp/12 Volt, 1-Groove Pulley

Used On: Toyota Lift Trucks
Replaces: Nippondenso 100211-697; Toyota 27070-23001-71
Lester Nos: 12185
Features: 100% New



1-2822-01ND-2
 (Ref# 12210N)

Alternator - Nippondenso IR/IF
20 Amp/24 Volt, 1-Groove Pulley

Used On: Toyota Lift Trucks
Replaces: Nippondenso 100211-410, Toyota 27060-78300-71
Lester Nos: 12210
Features: 100% New

HEAVY DUTY & OFF ROAD

HEAVY DUTY & OFF ROAD

NIPPONDENSO - ALTERNATORS

IR/IF (Int. Reg./Int. Fan) (cont'd)



1-2823-01ND-2

(Ref# 12357N)

**Alternator - Nippondenso IR/IF
50 Amp/12 Volt, 1-Groove Pulley**

Used On: Toyota Lift Trucks
Replaces: Nippondenso 101211-858, Toyota 27060-78156-71
Lester Nos: 12357
Features: 100% New



1-2851-01ND

**Alternator - Nippondenso IR/IF
120 Amp/12 Volt, 2-Groove Pulley**

Used On: John Deere Ag Tractors w/ 6-619, 6-466, N-855 Diesel Engines
Replaces: John Deere RE36246, RE37201, RE42123, RE44140, RE51921, TY6684; Nippondenso 100211-603, -605
Lester Nos: 12066
Features: 100% New

NIPPONDENSO - STARTERS

DD (Direct Drive)



2-1682-ND

(Ref# 16223)

**Starter - Nippondenso DD
0.8kW/12 Volt, CW, 9-Tooth Pinion**

Used On: Toyota Lift Trucks
Replaces: Nippondenso 028000-197; Toyota 28100-40015
Lester Nos: 16223



2-1962-ND

**Starter - Nippondenso DD
7.5kW/24 Volt, CW, 10-Tooth Pinion**

Used On: John Deere Equipment 6414
Replaces: John Deere RE15663, TY6654; Nippondenso 028000-525, 9702800-525
Lester Nos: 16655



2-2043-ND

**Starter - Nippondenso DD
4.0kW/12 Volt, CW, 10-Tooth Pinion**

Used On: John Deere Equipment 6076
Replaces: John Deere RE54874, Nippondenso 228000-237
Lester Nos: 18008



2-2044-ND

**Starter - Nippondenso DD
4.0kW/12 Volt, CW, 10-Tooth Pinion**

Used On: John Deere Equipment
Replaces: John Deere AR63341, TY6613, TY6712; Nippondenso 028000-397, 9702800-397
Lester Nos: 16644



2-2045-ND

**Starter - Nippondenso DD
7.5kW/24 Volt, CW, 10-Tooth Pinion**

Used On: John Deere Equipment 4239T
Replaces: John Deere RE15718, TY6718; Nippondenso 128000-048, 9712800-048
Lester Nos: 17371



2-2276-ND
(Ref# 16635N)

Starter - Nippondenso DD
4.0kW/12 Volt, CW, 10-Tooth Pinion

Used On: John Deere Equipment 6404, 6414, 6466, 6466NB
Replaces: John Deere AR41627, RE13722, TY6617, TY6713;
Nippondenso 028000-329, 9702800-329
Lester Nos: 16635
Features: 100% New



2-2710-ND-2
(Ref# 17353N)

Starter - Nippondenso DD
4.0kW/12 Volt, CW, 10-Tooth Pinion

Used On: Case Combines, Tractors
Replaces: Case 91902C1, A162469, A187728;
Nippondenso 028000-743, 128000-434, 128000-533
Lester Nos: 17353
Features: 100% New



2-2277-ND

Starter - Nippondenso DD
5.0kW/12 Volt, CW, 12-Tooth Pinion

Used On: John Deere Equipment 6531, 6619
Replaces: John Deere AR46886, AR62154, TY6612;
Nippondenso 028000-381, 9702800-381
Lester Nos: 16641

OSGR (Offset Gear Reduction)

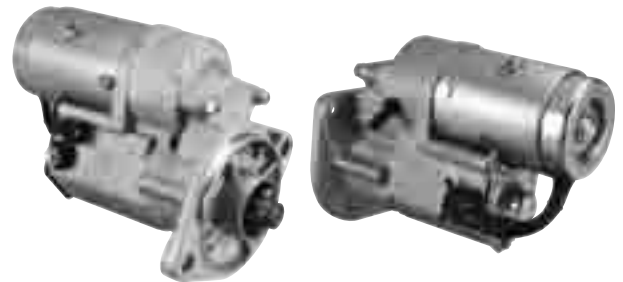

2-1193-ND

Starter - Nippondenso OSGR
2.0kW/12 Volt, CW, 9-Tooth Pinion

Used On: Hyster Lift Trucks, Isuzu Industrial Engines, Thermo King
Replaces: GM 94123387; Isuzu 5-81100-086-0, 5-81100-155-0; 5-81100-166-0, -1, -2, -3, -4; 5-81100-183-0, -1; 8-94123-387-0, 8-94149-249-0; 8-94412-730-0, -1; 8-94448-959-1;
Nippondenso 028000-506, -644, -700, -779; 128000-002, -096, -288; Thermo King 44-5674, 45-1229, 45-5657, 45-5674
Lester Nos: 16739
Note: 21mm static pinion length (mtg. flange to end of drive gear). 2-1193-ND is very similar to 2-2099-ND, except 2-2099-ND has a 11mm static pinion length.
Features: 100% New



2-2279-ND
(Ref# 17618N)

Starter - Nippondenso DD
4.0kW/12 Volt, CW, 10-Tooth Pinion

Used On: John Deere Equipment
Replaces: John Deere RE38336, RE43266, RE54416;
Nippondenso 128000-597, 228000-236, 9712800-597, 9722800-236
Lester Nos: 17618
Features: 100% New



2-2280-ND

Starter - Nippondenso DD
5.0kW/12 Volt, CW

Used On: Caterpillar 3208 Diesel Engine
Replaces: Caterpillar 122-6032, Nippondenso 228000-536

NIPPONDENSO - STARTERS

OSGR (Offset Gear Reduction) (cont'd)



2-1383-ND-2
(Ref# 17084N)

Starter - Nippondenso OSGR

1.4kW/12 Volt, CW, 10-Tooth Pinion

Used On: (1990-88) Dodge B Series Van 3.9L, 5.2L, 5.9L
(1990-88) Dodge D Series Pickup 3.9L, 5.2L, 5.9L
(1990-88) Dodge Dakota 3.9L, 5.2L
(1990-88) Dodge W Series Pickup 3.9L, 5.2L, 5.9L

Replaces: Chrysler 4379143, 144, 160;
Nippondenso 128000-496, -527, -528

Lester Nos: 17084

Features: 100% New



2-1397-ND-1
(Ref# 17215N)

Starter - Nippondenso OSGR Replacement

2.5kW/12 Volt, CW, 13-Tooth Pinion

Used On: (1993-89) Dodge D, W Series Pickup 5.9L Diesel

Replaces: Nippondenso 128000-491

Lester Nos: 17215

Note: Replacement design

Features: 100% New



2-1398-ND-2
(Ref# 17466N)

Starter - Nippondenso OSGR

1.4kW/12 Volt, CW, 10-Tooth Pinion

Used On: (1995-91) Dodge B Series Van 3.9, 5.2, 5.9L
(1993-91) Dodge D Series Pickup 3.9, 5.2, 5.9L
(1995-91) Dodge Dakota 3.9, 5.2L
(1995-94) Dodge Ram Pickup 3.9, 5.2, 5.9L
(1993-91) Dodge Ramcharger 5.2, 5.9L
(cont'd)

(cont'd)

(1993-91) Dodge W Series Pickup 3.9, 5.2, 5.9L

Replaces: Chrysler 53005984, Nippondenso 128000-781

Lester Nos: 17466

Features: 100% New



2-1526-ND
(Ref# 16990N)

Starter - Nippondenso OSGR

2.5kW/12 Volt, CW, 13-Tooth Pinion

Used On: Case, Ford, Versatile Loaders, Tractors; Cummins 3.9L, 5.9L Diesel Engines

Replaces: Case A170746; Cummins 3904466, 3920643;
Nippondenso 128000-021, 128000-054, 128000-227,
128000-248, 228000-195; Versatile 89332, 104668

Lester Nos: 16990

Features: 100% New

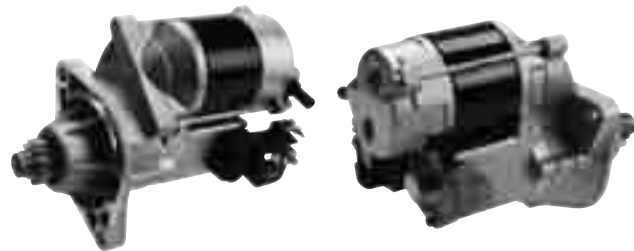

2-1717-ND
(Ref# 17549N)

Starter - Nippondenso OSGR

1.4kW/12 Volt, CW, 11-Tooth Pinion

Used On: (1995-94) Dodge Ram Pickup 8.0L

Replaces: Chrysler 56004757, Nippondenso 228000-180

Lester Nos: 17549

Features: 100% New



2-1726-ND-2
(Ref# 16658N)

Starter - Nippondenso OSGR

2.5kW/12 Volt, CW, 13-Tooth Pinion

Used On: Case Crawler, Loader

Replaces: Case 116930A1, A47496; Nippondenso 028000-588

Lester Nos: 16658

Note: Interchangeable with 2-1254-MI, 2-1747-MI, 50-8420-1,
(cont'd)

(cont'd)
 50-8437-1 (Lester Nos. 6573, 17037, 17577) used on Ford 7.3L Diesel Pickups
Features: 100% New



2-1737-ND
 (Ref# 17100)

Starter - Nippondenso OSGR
1.4kW/12 Volt, CW, 10-Tooth Pinion

Used On: Caterpillar Lift Trucks w/ Cat 1404 Engine or Continental F-163, F-227 Engines
Replaces: Caterpillar 3T5649, Nippondenso 028000-823
Lester Nos: 17100
Note: 2-1737-ND may be supplied with 2 or 3-mtg. holes.
Features: 100% New



2-1745-ND-1
 (Ref# 16881N)

Starter - Nippondenso OSGR
3.0kW/12 Volt, CW, 11-Tooth Pinion

Used On: Chevrolet, GMC Medium & Heavy Duty Trucks; Isuzu EVR, FSR, FTR, FVR, NRR Trucks 3.9L (4BD1), 5.8L (6BD1), 6.5L (6BG1) Engines
Replaces: GM 94039465; Isuzu 1-81100-234-0, -1; 8-97119-749-0, 2-91255-902-0; Nippondenso 128000-049
Lester Nos: 16881
Features: 100% New

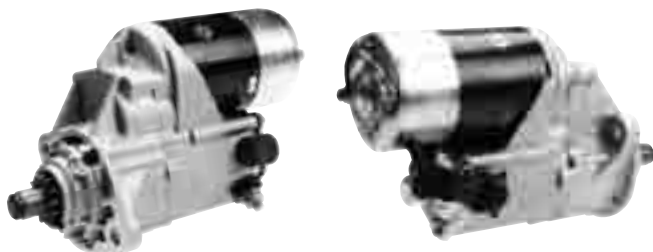

2-1750-ND
 (Ref# 17362N)

Starter - Nippondenso OSGR
2.7kW/12 Volt, CW, 13-Tooth Pinion

Used On: Bobcat Skid Steer Loader, Clark Skid Steer Loader, Elgin Sweeper w/ John Deere 4276 Diesel Engine

Replaces: Nippondenso 028000-840*, 228000-647
Lester Nos: 17362
Note: *2-1750-ND replaces early style Nippondenso 028000-840, 11-tooth starter.
Features: 100% New



2-1751-ND-2
 (Ref# 17391N)

Starter - Nippondenso OSGR
5.5kW/24 Volt, CW, 10-Tooth Pinion

Used On: Case, Samsung Ag & Industrial Equipment
Replaces: Case 1987566C1, D129494; Nippondenso 128000-256
Lester Nos: 17391
Features: 100% New



2-1753-ND
 (Ref# 17302N)

Starter - Nippondenso OSGR
2.5kW/12 Volt, CW, 11-Tooth Pinion

Used On: Isuzu Industrial Engines 4BD1, 6BD1
Replaces: Isuzu 5-81100-169-0, 5-81100-169-1; Nippondenso 028000-656, 128000-775
Lester Nos: 17302
Features: 100% New



2-1754-ND
 (Ref# 16614N)

Starter - Nippondenso OSGR
4.5kW/24 Volt, CW, 11-Tooth Pinion

Used On: Toyota Lift Trucks w/ 2J Engine
Replaces: Nippondenso 028000-586, Toyota 28100-22061
Lester Nos: 16614
Features: 100% New

HEAVY DUTY & OFF ROAD

HEAVY DUTY & OFF ROAD

NIPPONDENSO - STARTERS

OSGR (Offset Gear Reduction) (cont'd)

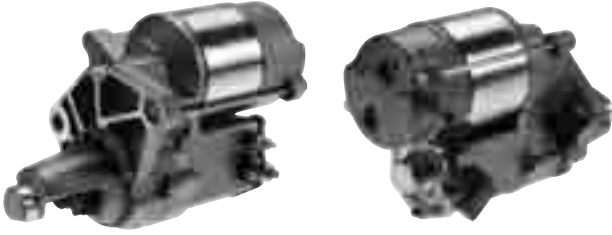

2-1807-ND-2
(Ref# 17573N)

Starter - Nippondenso OSGR
12 Volt, CW, 10-Tooth Pinion

Used On: (1998-96) Dodge B Series Van, Dakota, Ram Pickup 3.9L, 5.2L, 5.9L

(1998) Dodge Durango 5.2L, 5.9L

Replaces: Chrysler 56027702, Nippondenso 228000-339

Lester Nos: 17573

Features: 100% New



2-1822-ND

Starter - Nippondenso OSGR
1.4kW/12 Volt, CW, 11-Tooth Pinion

Used On: (1998-96) Dodge Ram Pickup 8.0L

Replaces: Chrysler 56027703, Nippondenso 228000-340

Lester Nos: 17574

Features: 100% New



2-1960-ND-2
(Ref# 18175N)

Starter - Nippondenso OSGR
1.4kW/12 Volt, CW, 11-Tooth Pinion

Used On: Carrier w/ Kubota Engines

Replaces: Carrier 25-37640, 25-37725-00, 25-38750-00;

Kubota 19013-63011, 19013-63012, 19013-63013,

19202-63011, 19202-63017, 19821-63011;

Nippondenso 028000-783; 128000-014, -628, -107

Lester Nos: 17116, 17367, 17619, 18175

Features: 100% New

(cont'd)

(cont'd)

2-1960-ND
(Ref# 17116)

Starter - Nippondenso OSGR

Note: Same as 2-1960-ND-2 except remanufactured



2-1981-ND-2
(Ref# 17785N)

Starter - Nippondenso OSGR
12 Volt, CW, 10-Tooth Pinion

Used On: (2003-99) Dodge Pickup, SUV, Van 3.7L, 3.9L, 4.7L, 5.2L, 5.9L

Replaces: Chrysler 56027702AB, AC; Nippondenso 228000-742

Lester Nos: 17785

Features: 100% New



2-1983-ND
(Ref# 17788N)

Starter - Nippondenso OSGR
1.4kW/12 Volt, CW, 11-Tooth Pinion

Used On: (2002-99) Dodge Ram Pickup 8.0L

Replaces: Chrysler 56027703AB, AC; Nippondenso 228000-743

Lester Nos: 17788

Features: 100% New



2-2072-ND
(Ref# 18274N)

Starter - Nippondenso OSGR Replacement
1.8kW/12 Volt, CW, 11-Tooth Pinion

Used On: Ford E Series Van, F Series Trucks 4.9, 5.0, 5.8 w/ MT

Replaces: Nippondenso 228000-844

Lester Nos: 18274

Note: Commercial & fleet replacement for Ford PMGR starters

(cont'd)

(cont'd)

WAI 2-1881-FD-1, Lester 3223).

Features: 100% New

Ideal for commercial fleets used in frequent stop/start applications
High durability, high torque starter in a compact & lightweight design



2-2099-ND

(Ref# 18449N)

Starter - Nippondenso OSGR
2.2kW/12 Volt, 9-Tooth Pinion

Used On: Hyster Lift Trucks w/ Isuzu C-240 Diesel Engines, Isuzu NHR Trucks

Replaces: Hyster 1347064, 3122813, Isuzu 8-97042-997-0, -1, -2; Nippondenso 228000-189, 228000-804

Lester Nos: 18449

Note: 11mm static pinion length (mtg. flange to end of drive gear).

2-2099-ND is very similar to 2-1193-ND, except 2-1193-ND has a 21mm static pinion length.

Features: 100% New



2-2104-ND

(Ref# 18181N)

Starter - Nippondenso OSGR
4.5kW/24 Volt, CW, 11-Tooth Pinion

Used On: Toyota Lift Trucks w/ B, 3B Diesel Engines

Replaces: Nippondenso 028000-553, Toyota 28100-56030

Lester Nos: 18181

Features: 100% New



2-2105-ND

(Ref# 18190N-7)

Starter - Nippondenso OSGR
4.5kW/24 Volt, CW, 11-Tooth Pinion

Used On: Industrial Equipment w/ Isuzu 6BB1 Diesel Engine

Replaces: Isuzu 1-81100-141-0, 5-81100-118-0, 8-81100-253-1; Nippondenso 028000-620

Lester Nos: 18190

Features: 100% New



2-2106-ND

(Ref# 16896N)

Starter - Nippondenso OSGR
4.5kW/24 Volt, CW, 11-Tooth Pinion

Used On: Toyota Lift Trucks w/ 2H Diesel Engine

Replaces: Nippondenso 028000-724, 028000-781; Toyota 28100-31625-71, 28100-47090, 28100-47091

Lester Nos: 16896

Features: 100% New



2-2107-ND

(Ref# 18144N)

Starter - Nippondenso OSGR
1.4kW/12 Volt, CW, 9-Tooth Pinion

Used On: Kubota L3100, L3450, L3650 Compact Tractors

Replaces: Nippondenso 228000-102; Kubota 15461-63013, 15461-63015

Lester Nos: 18144

Features: 100% New

HEAVY DUTY & OFF ROAD

NIPPONDENSO - STARTERS

OSGR (Offset Gear Reduction) (cont'd)

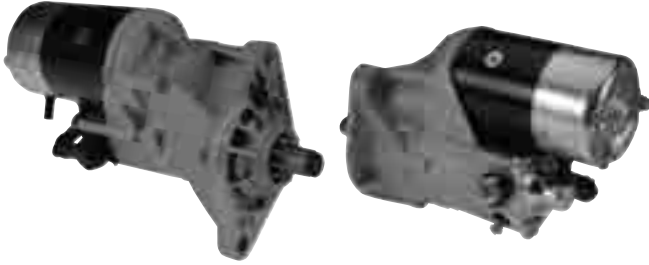

2-2108-ND

Starter - Nippondenso OSGR

4.5kW/24 Volt, CW, 11-Tooth Pinion

Used On: Industrial Equipment, Marine & Trucks w/ Hino W04CT, W04D, W06D, W06E Diesel Engines

Replaces: Hino 28100-1542, 28100-1900; Nippondenso 028000-976; Sawafuji 0350-402-0113, 0350-402-0210, 0350-402-0211



2-2197-ND

(Ref# 17802N)

Starter - Nippondenso OSGR

4.0kW/12 Volt, CW, 13-Tooth Pinion

Used On: (2003-01) Ford Excursion, F Series Pickup 7.3L (Power Stroke Diesel)

Replaces: Nippondenso 228000-842

Lester Nos: 17802

Note: 2-2197-ND will also replace 2-2197-FD (Lester 6669, Ford style, 2-mtg ear) & 2-1748-MI (Lester 17578, Mitsubishi style, 3-mtg. ear) starters.

When replacing 2-2197-FD (Lester 6669, Ford style) the 2-tabs on the vehicle's battery cable end must be snipped off in order for the cable to fit tightly on the 2-2197-ND battery stud & insulator.

Features: 100% New

Provides more power and faster cranking speed than original Ford OSGR design

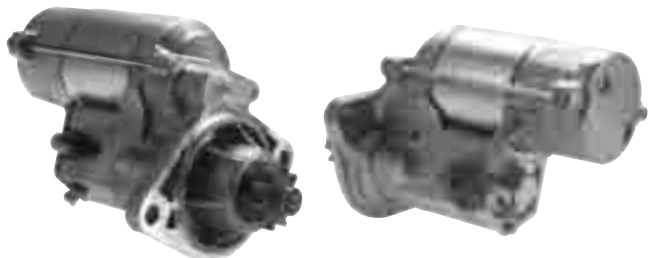

2-2203-ND

(Ref# 18198N)

Starter - Nippondenso OSGR

2.0kW/12 Volt, CW, 10-Tooth Pinion

Used On: Hyster Lift Trucks w/ GM 4.3L V6 engine
(cont'd)

(cont'd)

Replaces: Hyster 1383240, 8504304; Nippondenso 228000-586

Lester Nos: 18198

Note: Will also replace Lester 4200, 4525, 17622 starters.

Features: 100% New, wet clutch design



2-2222-ND

(Ref# S9104N)

Starter - Nippondenso OSGR

5.5kW/24 Volt, CW, 11-Tooth Pinion

Used On: Hino, Sawafuji Trucks

Replaces: Hino 28100-1863, Nippondenso 128000-468, Sawafuji 0350-552-0338

Features: 100% New



2-2223-ND

(Ref# S9108N)

Starter - Nippondenso OSGR

6.0kW/24 Volt, CW, 11-Tooth Pinion

Used On: Hino Trucks

Replaces: Hino 28100-1743A, Sawafuji 0350-602-0118

Features: 100% New



2-2224-ND

Starter - Nippondenso OSGR

7.0kW/24 Volt, CW, 11-Tooth Pinion

Used On: Hino Industrial Engines, Trucks

Replaces: Hino 28100-1645A, Sawafuji 0350-702-0180

HEAVY DUTY & OFF ROAD



2-2226-ND
(Ref# S9111N)

Starter - Nippondenso OSGR
5.5kW/24 Volt, CW, 11-Tooth Pinion

Used On: Hino Trucks w/ Nissan PF6 Engine
Replaces: Nissan 23300-96504, Sawafuji 0350-602-0261M
Features: 100% New



2-2238-ND
(Ref# 18151N)

Starter - Nippondenso OSGR
2.0kW/12 Volt, CW, 11-Tooth Pinion

Used On: Toyota Lift Trucks w/ 2.0L, L Diesel Engines
Replaces: Nippondenso 028000-737, Toyota 28100-54070
Lester Nos: 18151
Features: 100% New



2-2232-ND
(Ref# S6088N)

Starter - Nippondenso OSGR
2.5kW/12 Volt, CW, 11-Tooth Pinion

Used On: Komatsu Lift Trucks FD20 w/ 4D95S Diesel Engines
Replaces: Komatsu 600-813-1420, Nippondenso 128000-997
Features: 100% New



2-2239-ND
(Ref# 18197N)

Starter - Nippondenso OSGR
2.5kW/12 Volt, CW, 12-Tooth Pinion

Used On: Toyota Industrial Engines
Replaces: Nippondenso 228000-161, Toyota 28100-17040
Lester Nos: 18197
Features: 100% New



2-2234-ND
(Ref# S9103N)

Starter - Nippondenso OSGR
5.5kW/24 Volt, CW, 11-Tooth Pinion

Used On: Isuzu Trucks & Industrial Equipment w/ 6SD1 Engine
Replaces: Isuzu 1-81100-246-1, Nippondenso 128000-425
Features: 100% New



2-2263-ND
(Ref# 17615N)

Starter - Nippondenso OSGR
3.0kW/12 Volt, CW, 10-Tooth Pinion

Used On: Caterpillar Challenger 35, 45 Farm Tractors w/ 3114, 3116 Engines
Replaces: Caterpillar 3E5382, 9W2946; Nippondenso 128000-572
Lester Nos: 17615
Features: 100% New

HEAVY DUTY & OFF ROAD

HEAVY DUTY & OFF ROAD

NIPPONDENSO - STARTERS

OSGR (Offset Gear Reduction) (cont'd)



2-2265-ND
(Ref# S6067N)

Starter - Nippondenso OSGR
2.5kW/12 Volt, CW, 11-Tooth Pinion

Used On: Daihatsu, Toyota Industrial Equipment
Replaces: Nippondenso 028000-904, 128000-156,
Toyota 28100-56160, -56161, -89107
Features: 100% New



2-2327-ND
(Ref# 17823N)

Starter - Nippondenso OSGR
12 Volt, CW, 10-Tooth Pinion

Used On: (2005-04) Dodge Dakota, Durango 3.7L
(2005-02) Dodge Dakota 4.7L
(2003-02) Dodge Durango 4.7L
(2005-02) Dodge Ram Pickup 3.7L, 4.7L
(2003) Dodge Ram Pickup 5.7L
Replaces: Chrysler 56028715AD, 56029113AA;
Nippondenso 428000-010, 428000-201
Lester Nos: 17823
Features: 100% New



2-2356-ND-1
(Ref# 18406N)

Starter - Nippondenso OSGR
4.0kW/12 Volt, 10-Tooth Pinion

Used On: International-Navistar DT466 7.6L
Replaces: Nippondenso 228000-851
(cont'd)

(cont'd)

Lester Nos: 18406

Note: Wet clutch.

2-2356-ND-1 will also replace Delco 37MT starters: 1993713,
1993874 & others (WAI 50-162, Lester 6380)

Features: 100% New



2-2455-ND
(Ref# 17892N)

Starter - Nippondenso OSGR
2.7kW/12 Volt, CW, 13-Tooth Pinion

Used On: (2006-03) Dodge Ram Pickup 5.9L (Diesel)
Replaces: Chrysler 5086932AA, Cummins 4090084,
Nippondenso 428000-119
Lester Nos: 17892
Features: 100% New



2-2548-ND
(Ref# 17880N)

Starter - Nippondenso OSGR
12 Volt, CW, 11-Tooth Pinion

Used On: (2006-03) Chevrolet Avalanche 8.1L
(2007-03) Chevrolet Silverado, GMC Sierra 8.1L
(2006-03) Chevrolet Suburban, GMC Yukon XL 8.1L
Replaces: GM 12567709; Nippondenso 428000-046
Lester Nos: 17880
Features: 100% New



2-2655-ND
(Ref# 18158N)

Starter - Nippondenso OSGR
1.4kW/12 Volt, CW, 11-Tooth Pinion

Used On: Lister Petter LPA2, LPW2, LPWS2, LPWS3 2 Cyl. Tractor Engines
Replaces: Lister Petter 757-17980, 757-21700; Nippondenso 128000-810, 228000-188
Lester Nos: 18158
Features: 100% New

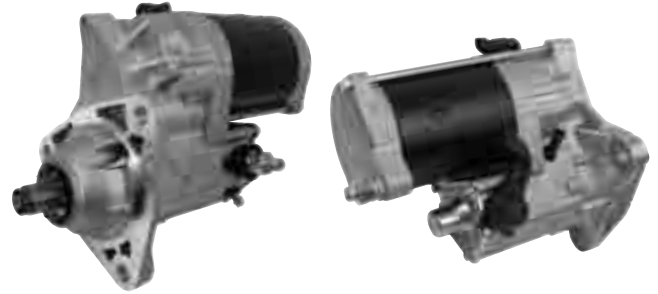

2-2666
(Ref# 18343N)

Starter - Nippondenso OSGR
4.0kW/12 Volt, CW, 10-Tooth Pinion

Used On: Cummins Engines
Replaces: Cummins 3283813, 3675245RX; Nippondenso 228000-562
Lester Nos: 18343
Features: 100% New



2-2656-ND
(Ref# 18419N)

Starter - Nippondenso OSGR
1.4kW/12 Volt, CW, 9-Tooth Pinion

Used On: Kubota Excavators, Tractors, Utility Vehicles w/ D902E-UV, D905E-BX, D1105BH, V1505BH 22-27hp Diesel Engines
Replaces: Kubota 16235-63010, -63011, -63012; K7561-61810, -61811; Nippondenso 228000-632, 428000-264
Lester Nos: 18419
Features: 100% New



2-2705-ND-2
(Ref# 16657N)

Starter - Nippondenso OSGR
1.4kW/12 Volt, CW, 15-Tooth Pinion

Used On: Carrier Transcold, John Deere, Thermo King w/ Yanmar Engines
Replaces: John Deere AM877285, CH12741, CH19284, TY6648, TY6673; Nippondenso 028000-573; Thermo King 45-1312, 45-1718; Yanmar 121120-77010
Lester Nos: 16657
Features: 100% New



2-2660-ND
(Ref# 18142N)

Starter - Nippondenso OSGR
1.4kW/12 Volt, CW, 11-Tooth Pinion

Used On: Kubota Tractors w/ 49.5-58hp Diesel Engines
Replaces: Kubota 15621-63013, 15621-63014, 15621-63015; Nippondenso 228000-100
Lester Nos: 18142
Features: 100% New



2-2708-ND-2
(Ref# 17290N)

Starter - Nippondenso OSGR
2.5kW/12 Volt, CW, 11-Tooth Pinion

Used On: Toyota Lift Trucks w/ 1DZ, 1Z, 2DZ Engines
Replaces: Nippondenso 128000-411; Toyota 28300-23040, 28300-23041-71
Lester Nos: 17290
Features: 100% New

HEAVY DUTY & OFF ROAD

HEAVY DUTY & OFF ROAD

NIPPONDENSO - STARTERS

OSGR (Offset Gear Reduction) (cont'd)



2-2709-ND-2
(Ref# 17292N)

Starter - Nippondenso OSGR

2.5kW/12 Volt, CW, 11-Tooth Pinion

Used On: Hino FA14, FA15, FB14, FB15 Trucks

Replaces: Hino 28100-1561A, -1562A, -1930A, -1931A, -1960A, -1961, -1961A; Mercury Marine 50-831001562, 50-831001961; Nippondenso 028000-977, 128000-509, 128000-530

Lester Nos: 17292

Features: 100% New

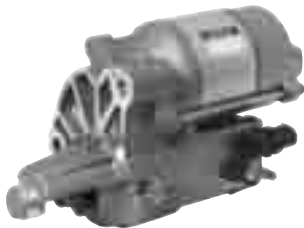

2-2722-ND-2
(Ref# 17875N)

Starter - Nippondenso OSGR

12 Volt, CW, 10-Tooth Pinion

Used On: (2003) Dodge Ram Pickup 5.7L w/ MT

Replaces: Chrysler 56028733AA; Nippondenso 428000-073

Lester Nos: 17875

Features: 100% New



2-2726-ND-2
(Ref# 18018N)

Starter - Nippondenso OSGR

4.0kW/12 Volt, CW, 11-Tooth Pinion

Used On: John Deere Combines, Tractors

Replaces: John Deere RE501294, RE501298, RE69704, RE70957, RE70975, TY24439; Nippondenso 228000-653, 228000-787

Lester Nos: 18018

Features: 100% New

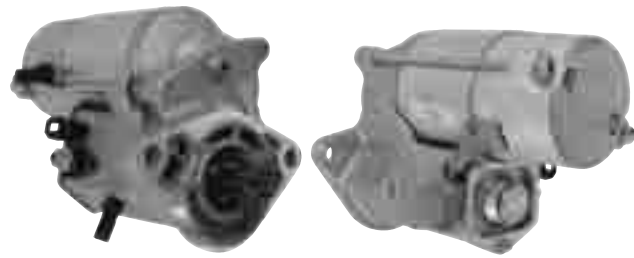

2-2732-ND-2
(Ref# 18139N)

Starter - Nippondenso OSGR

2.0kW/12 Volt, CW, 11-Tooth Pinion

Used On: Ford Tractors w/ 4-122, 4-135 Shibaura Diesel Engines

Replaces: Ishikawajima 185086520, 185086530; Nippondenso 228000-297, 228000-512

Lester Nos: 18139

Features: 100% New



2-2733-ND-2
(Ref# 18141N)

Starter - Nippondenso OSGR

1.4kW/12 Volt, CW, 11-Tooth Pinion

Used On: Kubota

Replaces: Kubota 17381-63014; Nippondenso 228000-104

Lester Nos: 18141

Features: 100% New



2-2734-ND-2
(Ref# 18145N)

Starter - Nippondenso OSGR

1.2kW/12 Volt, CW, 9-Tooth Pinion

Used On: Kubota Tractors w/ 26.5-35hp Diesel Engines

Replaces: Kubota 34070-16081, 34070-16083, 34070-16800, 34070-16803; Nippondenso 128000-846

Lester Nos: 18145

Features: 100% New



2-2735-ND-2
(Ref# 18148N)
Starter - Nippondenso OSGR
1.4kW/12 Volt, CW

Used On: Kubota
Replaces: Kubota 19215-63012, 19215-63013;
Nippondenso 228000-106
Lester Nos: 18148
Features: 100% New

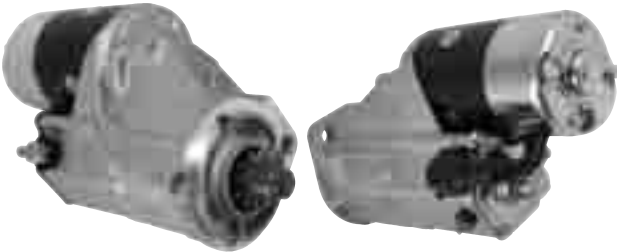

2-2784-ND-2
(Ref# 17311N)
Starter - Nippondenso OSGR
2.5kW/12 Volt, CW, 11-Tooth Pinion

Used On: Toyota 5FD, 6FD Series Lift Trucks w/ 1DZ, 1Z, 2J, 11Z Engines
Replaces: Nippondenso 128000-097, 228000-371;
Toyota 28100-23660-71, -40290-71, -40291-71
Lester Nos: 17311
Features: 100% New

PLGR (Planetary Gear Reduction)



2-2773-ND
(Ref# 18571N)
Starter - Nippondenso PLGR
5.0kW/12 Volt, CW, 12-Tooth Pinion

Replaces: Nippondenso 428000-122
Lester Nos: 18571
Note: Solenoid positioned at 52°
2-2773-ND can be used to replace 11-tooth Delco 40MT, 42MT starters: WAI 50-108, 50-153; Lester 3974, 6352, 6356
Features: 100% New



2-2774-ND
(Ref# 18572N)
Starter - Nippondenso PLGR
5.0kW/12 Volt, CW, 13-Tooth Pinion

Replaces: Nippondenso 428000-142
Lester Nos: 18572
Note: Solenoid positioned at 82°
2-2774-ND can be used to replace 12-tooth Delco 40MT, 42MT starters: WAI 50-100, 50-150, Lester 3339, 6371
Features: 100% New



2-2886-ND
(Ref# 18577N)
Starter - Nippondenso PLGR
8.0kW/24 Volt, CW, 12-Tooth Pinion

Replaces: Nippondenso 428000-145
Lester Nos: 18577
Note: Solenoid positioned at 82°
2-2886-ND can be used to replace 11-tooth Delco 40MT, 42MT starters: WAI 50-104, 50-151; Lester 3745, 6370, 6378
Features: 100% New

PRESTOLITE - ALTERNATORS



20-601
Alternator - Prestolite ANB Series
22 Amp/24 Volt, wo/ pulley

Used On: Case Tractors, Caterpillar Industrial Equipment
Replaces: Case A-44794; Caterpillar 2P1698;
Prestolite 51-212, ANB-6004
Lester Nos: 7331

VALEO - ALTERNATORS



1-2510-01VA
(Ref# 13860N)

Alternator - Valeo IR/IF

145 Amp/12 Volt, CW, 6-Groove Pulley

Used On: (2002-01) Chevrolet Suburban 5.3L, 6.0L, 8.1L
(2002-01) Chevrolet Tahoe 5.3L
(2002-01) GMC Yukon 5.3L, 6.0L
(2002-01) GMC Yukon XL 5.3L, 6.0L, 8.1L

Replaces: Bosch 6-004-ML0-024, Delco 15755900;
Valeo 2653016, TG15S096

Lester Nos: 13860

Features: 100% New



1-2602-01VA
(Ref# 11047N)

Alternator - Valeo IR/IF

100 Amp/12 Volt, CW, 6-Groove Pulley

Used On: (2006-04) Chevrolet Colorado 2.8L, 3.5L
(2006-04) GMC Canyon 2.8L, 3.5L

Replaces: GM 15831639, 97241516; Isuzu 8972415160,
8-97241-516-0; Valeo SG10S039, SG10S049, SG10S051,
SG10S051SP

Lester Nos: 11047

Features: 100% New



1-2614-01VA

Alternator - Valeo IR/EF

75 Amp/24 Volt, wo/ Pulley

Used On: Scania Truck

Replaces: Bosch 0-120-468-065, Renault 5010099875;
Scania 1105368, 1307454, 571518, Valeo A14N104, A14N138,
A14N160, A14N205

Features: Mfd. by OE supplier



1-2741-01VA

Alternator - Valeo IR/IF

70 Amp/12 Volt, CW, 5-Groove Pulley

Used On: Toro Ag Equipment w/ Peugeot Diesel
Citroen, Peugeot 1.5L Diesel (Europe)

Replaces: Peugeot-Citroen 5705L1, 5705N0, 5705N1;
Valeo A11VI45

Lester Nos: 12422

Features: 100% New

VALEO - STARTERS



2-2294-VA

Starter - Valeo PMGR

2.5kW/12 Volt, CW, 10-Tooth Pinion

Used On: John Deere 5200, 5300, 5400 Tractors w/ 320 2.9L
Engine

Replaces: John Deere RE60641, RE502156, RE501693;
Valeo 438012, 455735, D7R14

Lester Nos: 17086

Features: 100% New

DC MOTORS

Compressor Starting Motor



82-6872-1

**Motor - Compressor Starting Motor
12 Volt, CCW, .75" Dia. Shaft**

Used On: Oil Well Compressor Starting Motor

Replaces: Prestolite 46-419, 46-3627, 46-4036; MBJ-6002, MBJ-6002A, MBJ-6002S; Ref# W-9116

Dim: 4.5" Dia. Field Case
.75" Dia. Shaft w/ Key Slot
3" Dia. Mtg. Ring

1-3/4" Shaft to Mtg. Flange

4) 3/8-24 Mounting Holes

1) 5/16-24 Terminal Post

Note: Thru bolts at 3:00 & 9:00 positions.

Features: 100% New, double ball bearings

Pump Motors 12V



82-6854

Motor - Pump

12 Volt, CCW, Slotted Shaft

Used On: Anthony Equipment, Boss Snow Plows, Haldex-Barnes, Monarch Hydraulics, MTE Hydraulics, Waltco, Wapsa

Replaces: Haldex-Barnes 2200478, 2200727, 2200776, 2200820, 2200849; MTE Hydraulics 39200292, 39200388; Prestolite 46-2624, 46-2662, 46-4057, MUE-6106, MUE-6201, MUE-6201S, MUE-7004, MUE-7005, MUE-7005S, MUE-7006; Wapsa 9-130-450-061, 9-130-450-064, 9-130-450-081; Ref# W-8999

Lester Nos: 10751

Dim: 4.5" Dia. Field Case

1) 5/16-24 Terminal Post

Note: Thru bolts at 5:00 & 11:00 positions.

Additional 1/4-20 switch mtg. holes in field case for broader coverage.

For double ball bearing version use 82-6854-1.

For 4-field coil version use 82-6873.

Features: 100% New, high RPM motor, 2-field coils, single ball bearing



82-6854-1

Motor - Pump

Replaces: Ref# W-8999-DBB

Lester Nos: 10752

Note: Same as 82-6854 except w/ double ball bearings



82-6855

Motor - Pump

12 Volt, CW, Slotted Shaft

Used On: Applied Energy, Borg Warner, Cessna, Delta Power, Fenner Stone, Haldex-Barnes, MTE Hydraulics, Parker Hannifan, Stone Industries

Replaces: Prestolite 46-72, 46-888, 46-917, 46-958, 46-969, 46-974, 46-975, 46-990, 46-2014, 46-2015, 46-2037, 46-2478, 46-2550, 46-3563, 46-4050, 46-4068, MDY-6116, MDY-6116S, MDY-6124, MDY-6124S, MDY-6126, MDY-6126S, MDY-6128, MDY-6128S, MDY-6135, MDY-6135S, MDY-6157, MDY-6157S, MDY-7022, MDY-7031, MDY-7032, MDY-7032A, MDY-7032B, MDY-7037, MDY-7037S, MDY-7039, MDY-7039A, MDY-7039S, MDY-7042, MDY-7042A, MDY-7061, MDY-7063, MDY-7063S, MDY-7072, MDY-7072S, MUE-6113S; Ref# W-8990

Lester Nos: 6044

Dim: 4.5" Dia. Field Case

1) 5/16-24 Terminal Post

Note: Thru bolts at 5:00 & 11:00 positions.

For double ball bearing version use 82-6871-1

Features: 100% New, 4-field coils, single ball bearing

DC MOTORS

Pump Motors 12V (cont'd.)



82-6859

Motor - Pump

12 Volt, CCW, Slotted Shaft

Used On: Cessna, Monarch Hydraulics, MTE Hydraulics, Tommy Lifts

Replaces: Monarch 8111D; Prestolite 46-4058, MUE-6202, MUE-6202S; Ref# W-8911

Dim: 4.5" Dia. Field Case
1) 5/16-24 Terminal Post

Note: Thru bolts at 3:00 & 9:00 positions.
Additional 1/4-20 switch mtg. holes in field case for broader coverage. For 4-field coil version use 82-6860.

Features: 100% New, 2-field coils, single ball bearing



82-6860

Motor - Pump

12 Volt, CCW, Slotted Shaft

Used On: Cessna, Monarch Hydraulics, MTE Hydraulics, Tommy Lifts

Replaces: Prestolite 46-948, 46-2220, 46-2777, 46-2782, 46-4166, MHN-4001, MHN-4001A, MHN-4001B, MHN-4001S, MHN-4003, MHN-4005, MHN-4005A, MUE-6001, MUE-6107, MUE-6107S, MUP-6201, MUP-6201S; Ref# W-8993

Lester Nos: 6127

Dim: 4.5" Dia. Field Case
1) 5/16-24 Terminal Post

Note: Thru bolts at 3:00 & 9:00 positions.
Additional 1/4-20 switch mtg. holes in field case for broader coverage.

For double ball bearing version used 82-6860-1 or 82-6860-3

Features: 100% New, 3-field coils w/ shunt coil, single ball bearing



82-6860-1

Motor - Pump

Replaces: Ref# W-8993-DBB

Note: Same as 82-6860 except w/ double ball bearings.



82-6860-2

Motor - Pump

Replaces: Ref# W-9993

Note: Same as 82-6860 except later style w/ 4-field coils, single ball bearing



82-6860-3

Motor - Pump

Replaces: Ref# W-9993-DBB

Note: Same as 82-6860 except later style w/ 4-field coils, double ball bearings



82-6861

Motor - Pump

12 Volt, CCW, Slotted Shaft

Used On: Anthony Equipment, Eagle, Haldex-Barnes, Leyman, Maxon, Monarch Hydraulics, MTE Hydraulics, Thieman, Tommy Lifts, Walco
(cont'd.)

(cont'd.)

Replaces: Prestolite 46-0349, 46-2093, 46-2107, 46-2369, 46-2414, 46-2585, 46-2595, 46-349, 46-3520, 46-3553, 46-717, MDY-6101, MDY-6102, MDY-6119, MDY-6119S, MDY-6132, MDY-6132S, MDY-6134S, MDY-6143, MDY-6143S, MDY-7027, MDY-7043, MDY-7050, MDY-7057, MDY-7057A, MDY-7057S, MDY-7059, MDY-7068, MDY-7075, MUE-6104, MUE-6104S; Ref# W-8992

Lester Nos: 6033, 6034, 6119, 6121

Dim: 4.5" Dia. Field Case

1) 5/16-24 Terminal Post

Note: Thru bolts at 5:00 & 11:00 positions.

Additional 1/4-20 switch mtg. holes in field case for broader coverage.

Features: 100% New, 4-field coils, single ball bearing



82-6862

Motor - Pump

12 Volt, CCW, Slotted Shaft, Insulated Grd.

Used On: Haldex-Barnes, Hyster, Monarch Hydraulics, MTE Hydraulics, Raymond Corporation

Replaces: Prestolite 46-175, 46-584, 46-783, 46-2086, 46-2126, 46-2194, 46-2451, 46-2552, 46-2559, 46-2570, MDY-6103, MDY-6109, MDY-6115, MDY-6118, MDY-6121, MDY-6121S, MDY-6122, MDY-6134, MDY-6202, MDY-6202S, MDY-6203, MDY-6203S, MDY-6205, MDY-6206, MDY-6206S, MDY-7064, MDY-7065, MDY-7067S, MHA-6001, MHA-6001S, MUE-6121; Ref# W-8935

Lester Nos: 6035, 6037

Dim: 4.5" Dia. Field Case

2) 5/16-24 Terminal Posts

Note: Thru bolts at 6:00 & 12:00 positions.

Features: 100% New, 4-field coils, double ball bearings

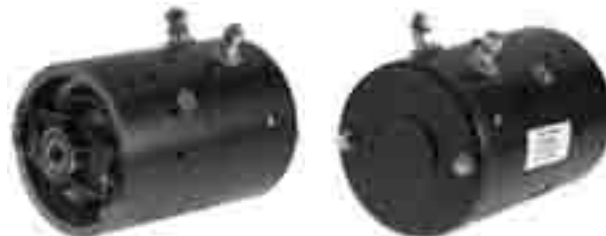

82-6863

Motor - Pump

12 Volt, CCW, Slotted Shaft, Insulated Grd.

Used On: Clark, Haldex-Barnes, Monarch Hydraulics

Replaces: Haldex-Barnes 2200975; Iskra 11-212-721, AMJ4680; Ref# 7004248, W-8735

Dim: 4.5" Dia. Field Case

2) 5/16-24 Terminal Posts

Note: Thru bolts at 3:00 & 9:00 positions.

Features: 100% New, 4-field coils, double ball bearings



82-6864

Motor - Pump

12 Volt, CW/CCW, Slotted Shaft

Used On: Fenner Stone Haldex-Barnes, Hahn Hydraulic, MTE Hydraulics, Venco

Replaces: MTE 39200397, 39200482; Prestolite 46-4220, MMQ-4002, MMQ-4003, MMQ-4003A, MMQ-4003AS, MMQ-4003S; Ref# W-8901-P

Lester Nos: 10721

Dim: 4.5" Dia. Field Case

2) 5/16-24 Terminal Posts

Note: Thru bolts at 3:00 & 9:00 positions.

Additional 1/4-20 switch mtg. holes in field case for broader coverage.

Features: 100% New, 4-field coils, double ball bearings
Bi-directional, forward & reverse



82-6869

Motor - Pump

12 Volt, CCW, Slotted Shaft

Used On: Haldex-Barnes, Leyman, Maxon, Monarch Hydraulics, MTE Hydraulics, Waltco, Wapsa

Replaces: Haldex-Barnes 2200072, 39200398; Monarch 8100; Prestolite 46-2054, 46-2495, 46-2516, 46-2534, 46-4038, 46-4154, MFX-4003, MFX-4003S, MMW-4001, MMW-4002, MMW-4002S, MMY-4001, MMY-4001A, MMY-4001S, MMY-4004, MMY-4004S, MMY-6101A, MMY-6101AS; Ref# W-8943

Dim: 4.5" Dia. x 6.875" Field Case

1) 5/16-24 Terminal Post

Note: Thru bolts at 3:00 & 9:00 positions.

Additional 1/4-20 switch mtg. holes in field case for broader coverage.

For double ball bearings use 82-6869-1

Features: 100% New, 4-field coils, single ball bearing



82-6869-1

Motor - Pump

Replaces: Ref# W-8943-DBB

Note: Same as 82-6869 except w/ double ball bearings.

DC MOTORS

Pump Motors 12V (cont'd.)

POWER EQUIPMENT



82-6870

Motor - Pump

12 Volt, CW, Slotted Shaft

Used On: Boss Snow Plows, Haldex-Barnes, Skidmore Equipment, Webster Electric

Replaces: Prestolite 46-812, 46-2432, 46-3564, MDY-6125, MDY-6125S, MDY-7030, MDY-7030S, MDY-7058, MDY-7058S; Ref# W-8958

Lester Nos: 6046

Dim: 4.5" Dia. Field Case

1) 5/16-24 Terminal Post

Note: Thru bolts at 5:00 & 11:00 positions. Additional 1/4-20 switch mtg. holes in field case for broader coverage.

Features: 100% New, bushing type



82-6871-1

Motor - Pump

12 Volt, CW, Slotted Shaft

Used On: Applied Energy, Borg Warner, Cessna, Delta Power, Fenner Stone, Haldex-Barnes, MTE Hydraulics, Parker Hannifan, Stone Industries

Replaces: Prestolite 46-72, 46-888, 46-917, 46-958, 46-969, 46-974, 46-975, 46-990, 46-2014, 46-2015, 46-2037, 46-2478, 46-2550, 46-3563, 46-4050, 46-4068, MDY-6116, MDY-6116S, MDY-6124, MDY-6124S, MDY-6126, MDY-6126S, MDY-6128, MDY-6128S, MDY-6135, MDY-6135S, MDY-6157, MDY-6157S, MDY-7022, MDY-7031, MDY-7032, MDY-7032A, MDY-7032B, MDY-7037, MDY-7037S, MDY-7039, MDY-7039A, MDY-7039S, MDY-7042, MDY-7042A, MDY-7061, MDY-7063, MDY-7063S, MDY-7072, MDY-7072S, MUE-6113S; Ref# W-8990-DBB

Lester Nos: 6044-DBB

Dim: 4.5" Dia. Field Case

1) 5/16-24 Terminal Post

Note: Thru bolts at 5:00 & 11:00 positions.

For single ball bearing version use 82-6855

Features: 100% New, 4-field coils, double ball bearings



82-6873

Motor - Pump

12 Volt, CCW, Slotted Shaft

Used On: Anthony Equipment, Haldex-Barnes, Monarch Hydraulics, MTE Hydraulics, Waltco, Wapsa

Replaces: Haldex-Barnes 2200654, MTE Hydraulics 39200380; Prestolite 46-2624, 46-2662, MUE-6108, MUE-6108S, MUE-7004, MUE-7005, MUE-7005S, MUE-7006, MUE-7006S; Ref# W-8799

Lester Nos: 10753

Dim: 4.5" Dia. Field Case

1) 5/16-24 Terminal Post

Note: Thru bolts at 5:00 & 11:00 positions. Additional 1/4-20 switch mtg. holes in field case for broader coverage.

For 2-field coil version use 82-6854.

Features: 100% New, 4-field coils, single ball bearing



82-6874

Motor - Pump

12 Volt, CCW, Slotted Shaft

Used On: Haldex-Barnes, Leyman, Maxon, Monarch Hydraulics, MTE Hydraulics, Waltco, Wapsa

Replaces: Haldex-Barnes 2200072, 39200398; Monarch 8100; Prestolite 46-2054, 46-2495, 46-2516, 46-2534, 46-4038, 46-4154, MFX-4003, MFX-4003S, MMW-4001, MMW-4002, MMW-4002S, MMY-4001, MMY-4001A, MMY-4001S, MMY-4004, MMY-4004S, MMY-6101A, MMY-6101AS; Ref# W-8945

Dim: 4.5" Dia. x 6.875" Field Case

1) 5/16-24 Terminal Post

Note: Thru bolts at 3:00 & 9:00 positions.

Additional 1/4-20 switch mtg. holes in field case for broader coverage.

Features: 100% New, 4-field coils, single ball bearing



82-6879
Motor - Pump
12 Volt, CW, Slotted Shaft

Used On: Haldex-Barnes, Hann Hydraulic, Leyman Manufacturing, Raymond Corp., Skidmore, Webster Electric
Replaces: Clark 878173, 907381; Haldex-Barnes 220-0006, 220-0218, GC-123D-C4; Prestolite 46-0416, 46-2543, 46-2611, ML-4355, ML-4357, ML-4364, ML-4368, ML-4375, ML-4502, ML-4502A, ML-4509, ML-4510, ML-4512, ML-5006, ML-5007, ML-5007S; Raymond 570-444; Yale 1294164-83, 1294164-91, 592303; Webster Electric 151-21044, 171-21044; Ref# W-5207
Lester Nos: 5381, 6093
Dim: 5" Dia. Field Case
 2) 3/8-16 Terminal Posts
Features: 100% New, heavy duty 5" dia. pump motor
 Double ball bearings



82-6880
Motor - Pump
12 Volt, CW, Slotted Shaft

Used On: Borg Warner, Fenner Stone, Haldex-Barnes, Maxon, MTE Hydraulics, Parker Hannifin, Venco, Waltco
Replaces: Prestolite 46-933, 46-992, 46-2018, 46-2520, 46-3550, MFX-4001, MFX-4001S, MFX-4002, MFX-4002S, MMW-4004, MMY-4002, MMY-4002S, MMY-4402, MMY-4402S; Ref# 1009633, 1917110100, 1917110300, 2200794, 2200949, 39200399, 422888, 50021054, 85456, 9130450039, 960373, DCM0006, M1039900, M1049992, M3200HD, W-8934
Lester Nos: 10715
Dim: 4.5" Dia. x 6.875" Field Case
 1) 5/16-24 Terminal Post
Note: Thru bolts at 3:00 & 9:00 positions.
 Additional 1/4-20 switch mtg. holes in field case for broader coverage.
Features: 100% New, 4-field coils, single ball bearing



82-6885
Motor - Pump
12 Volt, CW, 9-Spline Shaft

Used On: Dell Liftgates, Fenner Stone, Maxon, Snowaway Plows, Waltco
Replaces: Fenner Stone 1185AC, 1785AC, 1787AC, 1789AC, 1931AC, 1997AC; Prestolite 46-4048, 46-4072, MMY-6101, MUE-6114S; Ref# W-9789
Lester Nos: 10735
Dim: 4.5" Dia. Field Case
 1) 5/16-24 Terminal Post
Features: 100% New, double ball bearings



82-6887
Motor - Primer Pump
12 Volt, CW, Recessed Slot Shaft

Used On: Hale Fire Truck Primer Pumps
Replaces: Hale 2000041000; Prestolite 46-3663, MCL-6509, MCL-6509S; Ref# W-6542
Dim: 3.25" Dia. Mtg. Ring
Features: 100% New, double ball bearings, complete w/ switch



82-6888
Motor - Primer Pump
12 Volt, CW, Pin Hole Thru Shaft w/ Woodruff Key

Used On: Hale, Power Wheels Equipment, Purex Corp., Waterous Fire Truck Primer Pumps
Replaces: Hale 200004000; Prestolite 46-555, 46-557, 46-2155, 46-2244, 46-2604, 46-4200, MAY-4146, MAY-4301, MAY-4301S, MAY-4601, MCL-6225, MCL-6225A, MCL-6228, MCL-6508, MCL-6508S, MUE-6207, MUE-6207S; Ref# W-6559, W-6599
Lester Nos: 5196, 6005, 10718
Dim: 3.25" Dia. Mtg. Ring
Features: 100% New, double ball bearings, complete w/ switch & connector strap

DC MOTORS

Pump Motors 12V (cont'd.)



82-7851

Motor - Pump

12 Volt, CW, 9-Spline Shaft

Used On: Dell Liftgates, Fenner Stone, Maxon, Snowaway Plows, Waltco

Replaces: Fenner Stone 1185AC, 1785AC, 1787AC, 1789AC, 1931AC, 1997AC; Prestolite 46-4048, MUE-6114S

Lester Nos: 10736

Dim: 4.5" Dia. Field Case

1) 5/16-24 Terminal Post

Note: For heavy duty version use 82-6885

Features: 100% New, double ball bearings



82-7860

Motor - Pump

12 Volt, CCW, Slotted Shaft, Insulated Grd.

Used On: Haldex-Barnes, Hyster, Monarch Hydraulics, MTE Hydraulics, Raymond Corporation

Replaces: Bosch 0-136-350-011, 0-136-350-013; Iskra 11-212-108, AMJ5667; Ref# W-9007

Dim: 4.5" Dia. Field Case

2) 5/16-24 Terminal Posts

Note: Thru bolts at 6:00 & 12:00 positions.

Features: 100% New, gold Fenner style motor
Double ball bearings



82-7861

Motor - Pump

12 Volt, CW, 9-Spline Shaft, Insulated Grd.

Used On: Big Joe, Fenner Stone, Prime Mover

Replaces: Fenner Stone 1788AC, Iskra 11-212-385; Ref# W-9795

Lester Nos: 10739

Dim: 4.5" Dia. Field Case

2) 5/16-24 Terminal Posts

Features: 100% New, double ball bearings

Pump Motors, 24V



82-6875

Motor - Pump

24 Volt, CCW, Slotted Shaft, Insulated Grd.

Used On: Haldex-Barnes, Monarch Hydraulics, MTE Hydraulics

Replaces: Monarch 8119, MTE 39200295; Prestolite 46-2637, 46-2811, 46-3593, 46-3623, 46-3639, MFD-7009, MUF-6102, MUF-6102S, MUF-6104, MUF-6104S, MUF-7001, MUF-7002, MUF-7002S; Ref# W-8950

Lester Nos: 10750

Dim: 4.5" Dia. Field Case

2) 5/16-24 Terminal Posts

Note: Thru bolts at 6:00 & 12:00 positions.

Additional 1/4-20 switch mtg. holes in field case for broader coverage

Features: 100% New, 4-field coils, double ball bearings



82-6876

Motor - Pump

24 Volt, CCW, Slotted Shaft, Insulated Grd.

Used On: Baker, Clark, Fenner Stone, Monarch Hydraulics, Raymond Corp.

Replaces: Monarch 8120; Prestolite 46-0620, 46-2073, MHJ-2097, MHP-4005, MHP-4005S, MHP-4009, MHP-4009S; Raymond 570-429; Ref# W-9405

Lester Nos: 6129

Dim: 4.5" Dia. Field Case

2) 5/16-24 Terminal Posts

Note: Thru bolts at 3:00 & 9:00 positions

Features: 100% New, 4-field coils, single ball bearing



82-6877

Motor - Pump

24V, CW, Slotted Shaft, Permanent Magnet (PM)

Used On: Aerial Lifts, Haldex-Barnes, MTE Pumps, Scissor Lifts (cont'd.)

(cont'd.)

Replaces: 0920-0321, 2994BD00355, 39200321, 39200421, 4BD-00355, 562202X8912, D562202X8912, D562275X8375, W4BD-0355; Ref# W-0355

Dim: 4.5" Dia. Case, 13.5" OAL

Features: 100% New, permanent magnet design
4hp, 3600rpm, 150A full load, double ball bearings



82-6878

Motor - Pump

24V, CW, Amplex (Male) Shaft, Permanent Magnet (PM)

Used On: Aerial Lifts, Haldex-Barnes, Scissor Lifts

Replaces: 2200856, 2200945, 4BD-02273, W4BD-2273; Ref# W-2273

Dim: 4.5" Dia. Case, 14.2" OAL

Note: Armature shaft is the amplex or chrysler coupler type with 1/4-20 threaded hole.

Features: 100% New, permanent magnet design
4hp, 3600rpm, 150A full load, double ball bearings



82-6886

Motor - Pump

24 Volt, CCW, Slotted Shaft, Insulated Grd.

Used On: Haldex-Barnes

Replaces: Haldex-Barnes 2200972, 39200455; Ref# 638622095, W-8963

Dim: 4.5" Dia. Field Case

2) 5/16-24 Terminal Post

Note: Thru bolts at 3:00 & 9:00 positions.

Features: 100% New. double ball bearings

Snow Plow & Salt Spreader Motors



82-6852

Motor - Snow Plows

12 Volt, CW

Used On: Fisher, Western Snow Plows

Replaces: Prestolite 46-2473, 46-2584, 46-3618, 46-3938, MDL-2256, MKW-4009, MUE-6103, MUE-6103S, MUE-6111, MUE-6111S, MUE-6111S, MUE-6206, MUE-7001; Western 56058, 56062, 56133; Ref# W-8994

Lester Nos: 10725

Dim: 4.5" Dia. Field Case

1) 5/16-24 Terminal Post

Note: For sealed, double ball bearing version use 82-6889.

For version w/ insulated grd. Use 82-6852-1.

Features: 100% New, painted red
4-field coils, single ball bearing, oil seal at D.E.



82-6852-1

Motor - Snow Plows

12 Volt, CW, Insulated Grd.

Used On: Fisher, Western Snow Plows

Replaces: Prestolite 46-2473, 46-2584, 46-3938, MUE-6103, MUE-6111, MUE-6111S, MUE-7001; Ref# 46-4175

Dim: 4.5" Dia. Field Case

2) 5/16-24 Terminal Posts

Note: Without drive end frame for the new horizontally mounted plow motor, pump & reservoir assembly. Since the new style has the reservoir sideways, the drive end should not be removed.

For a 1-post motor w/ drive end frame use 82-6852.

Features: 100% New, 2-field coils, single ball bearing

DC MOTORS

Snow Plow & Salt Spreader Motors (cont'd.)

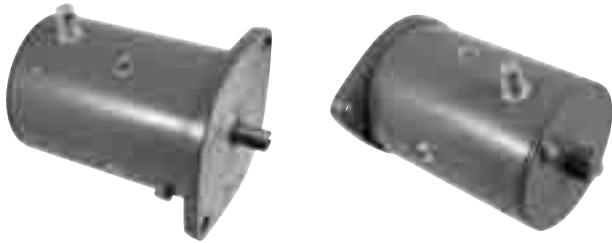

82-6853
Motor - Snow Plows
12 Volt, CW

Used On: Western Snow Plows (Early)
Replaces: Prestolite 46-806, MEZ-7002, Western 25556; Ref# W-8940
Lester Nos: 6067
Dim: 4.5" Dia. Field Case
 1) 5/16-24 Terminal Post
Features: 100% New, 4-field coils



82-6882
Motor - Snow Plows
12 Volt, CW, Slotted Shaft, Insulated Grd.

Used On: Meyer Quick Lift Snow Plows
Replaces: Iskra AMJ4739; Meyer 15829, 15841; Ref# W-5692
Dim: 4.5" Dia. Field Case
 2) 5/16-24 Terminal Posts
Features: 100% New, double ball bearings



82-6889
Motor - Snow Plows
12 Volt, CW

Used On: Fisher, Western Snow Plows
Replaces: Prestolite 46-2473, 46-2584, 46-3618, 46-3938, MDL-2256, MKW-4009, MUE-6103, MUE-6103S, MUE-6111, MUE-61118, MUE-6111S, MUE-6206, MUE-7001; Western 56058, 56062, 56133; Ref# W-6994
Dim: 4.5" Dia. Field Case
 1) 5/16-24 Terminal Post
Note: For single ball bearing version use 82-6852. For version w/ insulated grd. use 82-6852-1
Features: 100% New, painted red
 4-field coils, double ball bearings
 Oil seal at D.E., O-ring sealed end frames



82-7850
(Ref# 1961N)
Motor - Snow Plows
12 Volt, CCW

Used On: Meyer Snow Plow
Replaces: Meyer 15054; Prestolite 46-2415, MKW-4007; United Technologies MM48826
Lester Nos: 5200
Dim: 3" Dia. Field Case
Features: 100% New



82-7852
Motor - Snow Plows
12 Volt, CW, Slotted Shaft

Used On: Diamond Snow Plows, Meyer Quick Lift Snow Plows
Replaces: Iskra 11-212-981; Meyer 15689, 15727, 2529AB, 2529AC, 2869AB; Prestolite 46-4196, MUE-6209, MUE-6209S; Ref# W-8991
Lester Nos: 10710
Dim: 4.5" Dia. Field Case
 1) 5/16-24 Terminal Post
Features: 100% New, double ball bearings



82-7859
Motor - Salt Spreader
12 Volt, CCW

Used On: Meyers Salt Spreaders
Replaces: Johnson Electric 4854440; United Technologies 4854420M048HM, HM02223; Ref# W-8805
Lester Nos: 10711
Dim: 12.7mm (.5") Shaft Dia.
 2) 1/4-20 Terminal Posts
Features: 100% New, single ball bearing
 Seals & rings to keep out water

Winch Motors



82-6858

Motor - Winch

12 Volt, CW/CCW, .75" Dia. Shaft

Used On: Venco, Venturo-Santa Anita

Replaces: Prestolite 46-4071, MMQ-4004, MMQ-4004S; Ref# W-8938-P

Dim: 4.5" Dia. Field Case
.75" Dia. Shaft w/ Woodruff Key
3" Dia. Mtg. Ring
1.75" Shaft to Mtg. Flange
2) 5/16-24 Terminal Posts

Features: 100% New, double ball bearings
Bi-directional, forward & reverse



82-6865

Motor - Winch

12 Volt, CW/CCW, 20-Spline Shaft

Used On: Warn Industries Superwinch X Series

Replaces: Prestolite MRV-B7; Ref# 25314, 25981, 25982, M1901, W-7923

Lester Nos: 10747

Dim: 4.5" Dia. Field Case
3) 5/16-24 Terminal Posts

Features: 100% New, 4-field coils, single ball bearing
Bi-directional, forward & reverse



photo not available

82-6866

Motor - Winch

12 Volt, CW/CCW, .669" Dia. Shaft, 2.5hp

Used On: Braden, Warn Industries

Replaces: Prestolite 46-2262, MBJ-4401, MBJ-4401S, MBJ-4404; Ref# 8274, 8796, M3600, W-8941

Lester Nos: 10724

Dim: 4.5" Dia. Field Case
.669" Dia. Shaft w/ full length key slot
3) 5/16-24 Terminal Posts

Features: 100% New, single ball bearing
Bi-directional, forward & reverse



82-6867

Motor - Winch

12 Volt, CW/CCW, 20-Spline Shaft

Used On: Superwinch Husky Series, Warn Industries

Replaces: Prestolite MRV-B4, MRV-B5; Ref# 226626, 26629, 458058, 7536, 7682, AMJ4635, D2000, M1900, W-8923

Lester Nos: 10746

Dim: 4.5" Dia. Field Case
3) 5/16-24 Terminal Posts

Note: 82-6867 wo/ overload device (OLP)
For double ball bearing version use 82-6867-1.

Features: 100% New, 4-field coils, single ball bearing
Bi-directional, forward & reverse



82-6867-1

Motor - Winch

Replaces: Ref# W-8923-DBB

Note: Same as 82-6867 except w/ double ball bearings.



82-6868-1

Motor - Winch

12 Volt, CW/CCW, .75" Dia. Shaft, 2.5hp

Used On: Braden, Pierce Sales, Ramsey, Tulsa

Replaces: Prestolite 46-103, 46-2099, 46-2285, 46-2287, 46-2401, 46-2426, 46-2636, 46-4157, 46-4214, MBJ-4003, MBJ-4007, MBJ-4008, MBJ-4201, MBJ-4202, MBJ-4209, MBJ-4402, MBJ-4405, MBJ-4407, MBJ-4411, MBJ-4412, MBJ-4415, MBJ-4416, MBJ-6201, MRV-B8, MUR-6202, MUR-6202S; Ref# W-9143

Lester Nos: 5687-DB

Dim: 4.5" Dia. Field Case
.75" Dia. Shaft w/ Key Slot
3" Dia. Mtg. Ring
1.75" Shaft to Mtg. Flange
4) 3/8-24 Mounting Holes
3) 5/16-24 Terminal Posts

Note: For bushing version use 82-6868-3.
For 4.8HP heavy duty motor use 82-6868-2

Features: 100% New, double ball bearings
Bi-directional, forward & reverse

DC MOTORS

Winch Motors (cont'd.)



82-6868-2

Motor - Winch

Replaces: Ref# W-9144

Note: Same as 82-6868-1 except heavy duty 4.8hp motor



82-6868-3

Motor - Winch

Replaces: Ref# W-8933

Lester Nos: 5686

Note: Same as 82-6868-1 except bushing version.



photo not available

82-6881

Motor - Winch-Hoist

12 Volt, CW/CCW, .625" Dia. Shaft, 2.3hp

Used On: MY-TE, Santa Anita, Venco, Ventura Cranes, Winch-Hoists

Replaces: Ref# W-8842

Dim: 4.5" Dia. Field Case
 .625" Dia. Shaft w/ .125 Wide Bar Key Slot
 3" Dia. Mtg. Ring
 2.5" Shaft to Mtg. Flange
 3) 5/16-24 Terminal Post
 5/16 x 18 Thru Bolts

Features: 100% New, double ball bearings
 Bi-directional, forward & reverse



82-6884

Motor - Winch

12 Volt, CW/CCW, .75" Dia. Shaft, 2.5hp

Used On: Braden, Pierce Sales, Ramsey, Tulsa

Replaces: Prestolite 46-103, 46-2099, 46-2285, 46-2287, 46-2401, 46-2426, 46-2636, 46-4157, 46-4214, MBJ-4003, MBJ-4007, MBJ-4008, MBJ-4201, MBJ-4202, MBJ-4209, MBJ-4402, MBJ-4405, MBJ-4407, MBJ-4411, MBJ-4412, MBJ-4415, MBJ-4416, MBJ-6201, MRV-B8, MUR-6202, MUR-6202S; Ref# W-9133

Dim: 4.5" Dia. Field Case
 .75" Dia. Shaft w/ Key Slot
 3" Dia. Mtg. Ring
 1.75" Shaft to Mtg. Flange
 4) 3/8-24 Mounting Holes
 3) 5/16-24 Terminal Posts

Note: For bushing version use 82-6868-3.

Features: 100% New, double ball bearings
 Bi-directional, forward & reverse
 Easy change brushes



photo not available

82-6890

Motor - Winch

12 Volt, CCW, 14-Tooth Gear

Used On: Bellview, Warn Industries

Replaces: Prestolite 46-3650, MHT-6101, MHT-6101S, MHT-7001, MHT-7101, MHT-7101S; Ref# W-8703

Lester Nos: 10732

Note: Thru bolts at 5:00 & 11:00 positions.
 C.E. shaft has hole for roll pin.

Motor has steel C.E. plate w/ center hole for the shaft. Must be used w/ original C.E. brake assy. if needed.

Features: 100% New, 4-field coils



82-7862

Motor - Marine Winch-Hoist

12 Volt, CW/CCW, .625" Dia. Shaft, Insulated Grd.

Used On: Applied Motors, Electrodyne, Pacific Scientific Anchor Lifts & Lobster Pot Haulers

Replaces: Ref# 12641560, A361412641560, M2400, W-8930B

Dim: .625" Dia. Shaft w/ Bar Key Slot

3) 5/16-24 Terminal Post

Note: Offset post is the insulated ground terminal. Includes grounding cable.

Features: 100% New, double ball bearings
Bi-directional, forward & reverse



photo not available

82-7871

Motor - Winch

12 Volt, CW/CCW, Tang Shaft Motor

Used On: Truck Tarp Cover Motors

Replaces: Ref# 1110, 1102, 1307, 1646, B01-006A, W-8023

Dim: .520" Shaft Dia.

.170 W x .205 D Armature Flats

2) 1/4-28 Terminals

Note: Motor mounts on 1/4-20 thru bolts extensions

Features: 100% New

Bi-directional, forward & reverse

POWER EQUIPMENT

POWER EQUIPMENT

CROSS REFERENCE - REF# to CATALOG#

| Mfr. Part# | Catalog# | Mfr. Name | Pg. # | Mfr. Part# | Catalog# | Mfr. Name | Pg. # |
|---------------|-------------|-----------|-------|---------------|-------------|-----------|-------|
| 0-001-107-078 | 2-2690-BO | Bosch | 9 | 0-001-367-075 | 2-1803-BO-2 | Bosch | 4 |
| 0-001-109-029 | 2-2362-BO | Bosch | 8 | 0-001-367-078 | 2-1803-BO-2 | Bosch | 4 |
| 0-001-109-035 | 2-2553-BO | Bosch | 8 | 0-001-367-300 | 50-9100-1 | Bosch | 5 |
| 0-001-109-250 | 2-2355-BO | Bosch | 8 | 0-001-367-301 | 50-9100-1 | Bosch | 5 |
| 0-001-109-250 | 2-2355-BO-1 | Bosch | 8 | 0-001-367-303 | 50-9100-1 | Bosch | 5 |
| 0-001-218-172 | 2-1946-BO | Bosch | 7 | 0-001-368-001 | 50-9110-1 | Bosch | 7 |
| 0-001-218-174 | 2-2463-BO | Bosch | 8 | 0-001-368-007 | 50-9110-1 | Bosch | 7 |
| 0-001-223-002 | 2-1946-BO | Bosch | 7 | 0-001-368-019 | 2-2283-BO | Bosch | 4 |
| 0-001-223-005 | 2-2355-BO | Bosch | 8 | 0-001-368-020 | 50-9122-1 | Bosch | 7 |
| 0-001-223-005 | 2-2355-BO-1 | Bosch | 8 | 0-001-368-021 | 2-2284-BO | Bosch | 4 |
| 0-001-230-006 | 2-2736-BO-2 | Bosch | 8 | 0-001-368-024 | 2-2297-BO | Bosch | 4 |
| 0-001-231-002 | 2-2770-NK | Bosch | 94 | 0-001-368-026 | 2-2299-BO | Bosch | 5 |
| 0-001-231-033 | 2-2770-NK | Bosch | 94 | 0-001-368-040 | 2-2299-BO | Bosch | 5 |
| 0-001-358-046 | 50-9124-1 | Bosch | 7 | 0-001-368-048 | 2-2297-BO | Bosch | 4 |
| 0-001-358-047 | 50-9107 | Bosch | 6 | 0-001-368-051 | 2-2299-BO | Bosch | 5 |
| 0-001-358-048 | 50-9100-1 | Bosch | 5 | 0-001-368-055 | 2-2297-BO | Bosch | 4 |
| 0-001-358-049 | 50-9124-1 | Bosch | 7 | 0-001-368-062 | 2-2297-BO | Bosch | 4 |
| 0-001-359-021 | 50-9101-1 | Bosch | 6 | 0-001-368-085 | 2-2285-BO | Bosch | 4 |
| 0-001-359-022 | 50-9102 | Bosch | 6 | 0-001-368-300 | 2-2297-BO | Bosch | 4 |
| 0-001-359-027 | 50-9109-1 | Bosch | 6 | 0-001-368-306 | 2-2680-BO | Bosch | 5 |
| 0-001-359-032 | 50-9102 | Bosch | 6 | 0-001-368-307 | 2-2297-BO | Bosch | 4 |
| 0-001-359-043 | 50-9100-1 | Bosch | 5 | 0-001-368-309 | 2-2297-BO | Bosch | 4 |
| 0-001-359-073 | 50-9109-1 | Bosch | 6 | 0-001-369-001 | 2-1803-BO-2 | Bosch | 4 |
| 0-001-359-084 | 50-9100-1 | Bosch | 5 | 0-001-369-005 | 2-1803-BO-2 | Bosch | 4 |
| 0-001-359-091 | 50-9900 | Bosch | 49 | 0-001-369-022 | 2-1803-BO-2 | Bosch | 4 |
| 0-001-359-101 | 50-9102 | Bosch | 6 | 0-001-410-024 | 50-9117 | Bosch | 7 |
| 0-001-359-102 | 50-9101-1 | Bosch | 6 | 0-001-410-053 | 50-9115 | Bosch | 7 |
| 0-001-359-122 | 50-9105-1 | Bosch | 6 | 0-001-410-062 | 50-9115 | Bosch | 7 |
| 0-001-360-007 | 2-2284-BO | Bosch | 4 | 0-001-410-063 | 50-9115 | Bosch | 7 |
| 0-001-360-011 | 2-2297-BO | Bosch | 4 | 0-001-410-081 | 50-9115 | Bosch | 7 |
| 0-001-360-012 | 50-9110-1 | Bosch | 7 | 0-001-410-088 | 50-9117 | Bosch | 7 |
| 0-001-360-014 | 50-9110-1 | Bosch | 7 | 0-001-410-099 | 50-9115 | Bosch | 7 |
| 0-001-360-015 | 2-2283-BO | Bosch | 4 | 0-001-410-109 | 50-9115 | Bosch | 7 |
| 0-001-360-022 | 2-2297-BO | Bosch | 4 | 0-001-411-009 | 50-9117 | Bosch | 7 |
| 0-001-360-027 | 2-2284-BO | Bosch | 4 | 0-001-411-022 | 50-9117 | Bosch | 7 |
| 0-001-360-030 | 50-9110-1 | Bosch | 7 | 0-001-415-001 | 50-9117 | Bosch | 7 |
| 0-001-360-034 | 2-2297-BO | Bosch | 4 | 0-001-415-011 | 50-9115 | Bosch | 7 |
| 0-001-360-035 | 50-9110-1 | Bosch | 7 | 0-001-415-027 | 50-9117 | Bosch | 7 |
| 0-001-360-037 | 2-2297-BO | Bosch | 4 | 0-001-416-002 | 50-9117 | Bosch | 7 |
| 0-001-360-043 | 2-2283-BO | Bosch | 4 | 0-001-416-003 | 50-9115 | Bosch | 7 |
| 0-001-360-063 | 50-9122-1 | Bosch | 7 | 0-001-416-005 | 50-9115 | Bosch | 7 |
| 0-001-362-016 | 50-9124-1 | Bosch | 7 | 0-001-416-010 | 50-9117 | Bosch | 7 |
| 0-001-362-032 | 2-2325-BO | Bosch | 5 | 0-001-416-023 | 50-9117 | Bosch | 7 |
| 0-001-362-034 | 50-9124-1 | Bosch | 7 | 0-001-416-029 | 50-9115 | Bosch | 7 |
| 0-001-362-039 | 2-2325-BO | Bosch | 5 | 0-001-416-030 | 50-9115 | Bosch | 7 |
| 0-001-362-046 | 50-9107 | Bosch | 6 | 0-001-416-078 | 50-9117 | Bosch | 7 |
| 0-001-362-084 | 2-2292-LU | Bosch | 80 | 0-001-417-001 | 50-9117 | Bosch | 7 |
| 0-001-362-084 | 2-2292-LU-1 | Bosch | 80 | 0-001-417-037 | 50-9117 | Bosch | 7 |
| 0-001-362-091 | 50-9124-1 | Bosch | 7 | 0-001-421-004 | 50-100-1 | Bosch | 40 |
| 0-001-362-093 | 2-2301-LU | Bosch | 78 | 0-001-421-004 | 50-100-2 | Bosch | 40 |
| 0-001-362-105 | 2-2325-BO | Bosch | 5 | 001-151-94-01 | 50-9100-1 | Mercedes | 5 |
| 0-001-362-305 | 50-9124-1 | Bosch | 7 | 001-151-96-01 | 2-2297-BO | Mercedes | 4 |
| 0-001-362-310 | 2-2707-BO-2 | Bosch | 5 | 001-151-97-01 | 50-9117 | Mercedes | 7 |
| 0-001-362-311 | 50-9124-1 | Bosch | 7 | 002-151-02-01 | 50-9117 | Mercedes | 7 |
| 0-001-362-312 | 2-1803-BO-2 | Bosch | 4 | 002-151-28-01 | 50-9117 | Mercedes | 7 |
| 0-001-362-313 | 50-9124-1 | Bosch | 7 | 002-151-53-01 | 50-9117 | Mercedes | 7 |
| 0-001-362-316 | 2-1803-BO-2 | Bosch | 4 | 0025841044 | 2-2680-BO | Renault | 5 |
| 0-001-362-322 | 2-2325-BO | Bosch | 5 | 003-151-04-01 | 2-2297-BO | Mercedes | 4 |
| 0-001-362-332 | 2-2325-BO | Bosch | 5 | 003-151-05-01 | 50-9100-1 | Mercedes | 5 |
| 0-001-362-527 | 2-2707-BO-2 | Bosch | 5 | 003-151-41-01 | 50-9117 | Mercedes | 7 |
| 0-001-363-101 | 50-9108 | Bosch | 6 | 003-151-45-01 | 50-9117 | Mercedes | 7 |
| 0-001-363-111 | 50-9108 | Bosch | 6 | 003-151-46-01 | 50-9117 | Mercedes | 7 |
| 0-001-363-307 | 2-2297-BO | Bosch | 4 | 003-151-62-01 | 50-9117 | Mercedes | 7 |
| 0-001-367-004 | 50-9109-1 | Bosch | 6 | 003-151-64-01 | 50-9117 | Mercedes | 7 |
| 0-001-367-014 | 50-9900 | Bosch | 49 | 003-151-73-01 | 50-9100-1 | Mercedes | 5 |
| 0-001-367-028 | 50-9101-1 | Bosch | 6 | 003-151-74-01 | 2-2297-BO | Mercedes | 4 |
| 0-001-367-029 | 50-9105-1 | Bosch | 6 | 003-151-86-01 | 2-2297-BO | Mercedes | 4 |
| 0-001-367-033 | 50-9102 | Bosch | 6 | 004-151-22-01 | 50-9100-1 | Mercedes | 5 |
| 0-001-367-034 | 50-9100-1 | Bosch | 5 | 004-151-50-01 | 2-2822-DR | Mercedes | 40 |
| 0-001-367-042 | 2-2707-BO-2 | Bosch | 5 | 004-151-58-01 | 50-9100-1 | Mercedes | 5 |
| 0-001-367-059 | 50-9100-1 | Bosch | 5 | 004-151-59-01 | 2-2297-BO | Mercedes | 4 |
| 0-001-367-069 | 2-2298-BO | Bosch | 4 | 004-151-60-01 | 50-9117 | Mercedes | 7 |

CROSS REFERENCE

CROSS REFERENCE - REF# to CATALOG#

| Mfr. Part No. | Catalog No. | Mfr. Name | Pg. # | Mfr. Part No. | Catalog No. | Mfr. Name | Pg. # |
|---------------|---------------|-----------|-------|----------------|-------------|--------------|-------|
| 004-151-61-01 | 50-9117 | Mercedes | 7 | 013-154-17-02 | 1-2768-01BO | Mercedes | 3 |
| 004-151-84-01 | 2-2770-NK | Mercedes | 94 | 013-154-32-02 | 1-2589-01BO | Mercedes | 3 |
| 005-151-10-01 | 2-2823-DR | Mercedes | 40 | 0-136-350-011 | 82-7860 | Bosch | 118 |
| 005-151-13-01 | 2-2355-BO | Mercedes | 8 | 0-136-350-013 | 82-7860 | Bosch | 118 |
| 005-151-13-01 | 2-2355-BO-1 | Mercedes | 8 | 0-21000-4190 | 2-2828-NK | Nikko | 94 |
| 005-151-20-01 | 2-2770-NK | Mercedes | 94 | 0-21000-4191 | 2-2828-NK | Nikko | 94 |
| 005-151-29-01 | 2-2355-BO | Mercedes | 8 | 0-21000-4192 | 2-2828-NK | Nikko | 94 |
| 005-151-29-01 | 2-2355-BO-1 | Mercedes | 8 | 021000-465 | 20-209-9 | Nippondenso | 50 |
| 005-151-50-01 | 2-2822-DR | Mercedes | 40 | 021000-728 | 1-2461-01ND | Nippondenso | 94 |
| 005-151-64-01 | 2-2822-DR | Mercedes | 40 | 021000-741 | 1-2236-10ND | Nippondenso | 97 |
| 005-151-66-01 | 2-2355-BO | Mercedes | 8 | 021000-742 | 1-2236-10ND | Nippondenso | 97 |
| 005-151-66-01 | 2-2355-BO-1 | Mercedes | 8 | 021000-874 | 1-2236-10ND | Nippondenso | 97 |
| 005-151-70-01 | 2-2823-DR | Mercedes | 40 | 021000-875 | 1-2236-10ND | Nippondenso | 97 |
| 006-151-22-01 | 2-2770-NK | Mercedes | 94 | 0-23000-1020 | 2-1951-NK-1 | Nikko | 93 |
| 006-151-22-03 | 2-2770-NK | Mercedes | 94 | 0-23000-1030 | 2-1951-NK-1 | Nikko | 93 |
| 007-154-92-02 | 1-2711-00BO | Mercedes | 2 | 0-23000-1031 | 2-1951-NK-1 | Nikko | 93 |
| 007-154-92-02 | 1-2711-01BO | Mercedes | 2 | 0-23000-1032 | 2-1951-NK-1 | Nikko | 93 |
| 007-154-99-02 | 1-2711-00BO | Mercedes | 2 | 0-23000-1033 | 2-1951-NK-1 | Nikko | 93 |
| 007-154-99-02 | 1-2711-01BO | Mercedes | 2 | 0-23000-1070 | 2-1951-NK-1 | Nikko | 93 |
| 011-154-70-02 | 1-2589-01BO | Mercedes | 3 | 0-23000-1071 | 2-1951-NK-1 | Nikko | 93 |
| 0-120-468-028 | 1-2045-01BO-2 | Bosch | 2 | 0-23000-1670 | 2-1951-NK-1 | Nikko | 93 |
| 0-120-468-053 | 1-2711-00BO | Bosch | 2 | 0-23000-2350 | 2-2770-NK | Nikko | 94 |
| 0-120-468-053 | 1-2711-01BO | Bosch | 2 | 0-23000-2358 | 2-2770-NK | Nikko | 94 |
| 0-120-468-065 | 1-2614-01VA | Bosch | 112 | 0-23000-2590 | 2-2770-NK | Nikko | 94 |
| 0-120-468-107 | 1-2711-00BO | Bosch | 2 | 0-23000-3150 | 2-2729-NK-2 | Nikko | 94 |
| 0-120-468-107 | 1-2711-01BO | Bosch | 2 | 0-23000-3151 | 2-2729-NK-2 | Nikko | 94 |
| 0-120-468-113 | 1-2711-00BO | Bosch | 2 | 0-23000-3152 | 2-2729-NK-2 | Nikko | 94 |
| 0-120-468-113 | 1-2711-01BO | Bosch | 2 | 0-23000-3153 | 2-2729-NK-2 | Nikko | 94 |
| 0-120-484-002 | 1-2435-01BO | Bosch | 73 | 0-23000-6250 | 2-2730-NK-2 | Nikko | 94 |
| 0-120-484-003 | 1-2435-01BO | Bosch | 73 | 0-23000-6251 | 2-2730-NK-2 | Nikko | 94 |
| 0-120-484-011 | 1-2344-00BO | Bosch | 2 | 0-23000-6530 | 2-2731-NK-2 | Nikko | 94 |
| 0-120-484-016 | 1-2435-01BO | Bosch | 73 | 0-23000-6531 | 2-2731-NK-2 | Nikko | 94 |
| 0-120-484-018 | 1-2344-00BO | Bosch | 2 | 0-23000-6532 | 2-2731-NK-2 | Nikko | 94 |
| 0-120-484-020 | 1-2435-01BO | Bosch | 73 | 0-23000-6533 | 2-2731-NK-2 | Nikko | 94 |
| 0-120-484-026 | 1-2344-00BO | Bosch | 2 | 02-7014930 | 20-501-1 | Western Star | 73 |
| 0-120-488-205 | 1-2237-00BO | Bosch | 2 | 02-7014931 | 20-501-1 | Western Star | 73 |
| 0-120-488-293 | 1-2237-00BO | Bosch | 2 | 02-7023152 | 20-501-1 | White | 73 |
| 0-120-489-251 | 1-2754-02LU | Bosch | 77 | 028000-101 | 2-1682-ND | Nippondenso | 100 |
| 0-120-489-252 | 1-2754-02LU | Bosch | 77 | 028000-197 | 2-1682-ND | Nippondenso | 100 |
| 012-154-15-02 | 1-2589-01BO | Mercedes | 3 | 028000-329 | 2-2276-ND | Nippondenso | 101 |
| 012-154-20-02 | 1-2768-01BO | Mercedes | 3 | 028000-329 | 50-159-1 | Nippondenso | 36 |
| 012-154-22-02 | 1-2768-01BO | Mercedes | 3 | 028000-381 | 2-2277-ND | Nippondenso | 101 |
| 0-121-544-602 | 1-2589-01BO | Bosch | 3 | 028000-397 | 2-2044-ND | Nippondenso | 100 |
| 012-154-46-02 | 1-2589-01BO | Mercedes | 3 | 028000-506 | 2-1193-ND | Nippondenso | 101 |
| 0-123-520-023 | 1-2589-01BO | Bosch | 3 | 028000-525 | 2-1962-ND | Nippondenso | 100 |
| 0-124-325-039 | 1-2768-01BO | Bosch | 3 | 028000-553 | 2-2104-ND | Nippondenso | 105 |
| 0-124-325-046 | 1-2768-01BO | Bosch | 3 | 028000-569 | 2-2104-ND | Nippondenso | 105 |
| 0-124-325-093 | 1-2768-01BO | Bosch | 3 | 028000-573 | 2-2705-ND-2 | Nippondenso | 109 |
| 0-124-425-035 | 1-2878-01BO | Bosch | 3 | 028000-586 | 2-1754-ND | Nippondenso | 103 |
| 0-124-525-002 | 1-2526-01BO-2 | Bosch | 1 | 028000-588 | 2-1726-ND-2 | Nippondenso | 102 |
| 0-124-525-004 | 1-2227-02BO | Bosch | 1 | 028000-620 | 2-2105-ND | Nippondenso | 105 |
| 0-124-525-006 | 1-2553-01BO | Bosch | 1 | 028000-644 | 2-1193-ND | Nippondenso | 101 |
| 0-124-525-007 | 1-2541-01BO | Bosch | 1 | 028000-656 | 2-1753-ND | Nippondenso | 103 |
| 0-124-525-041 | 1-2877-01BO | Bosch | 1 | 028000-700 | 2-1193-ND | Nippondenso | 101 |
| 0-124-525-051 | 1-2553-01BO | Bosch | 1 | 028000-724 | 2-2106-ND | Nippondenso | 105 |
| 0-124-525-085 | 1-2547-00BO | Bosch | 2 | 028000-737 | 2-2238-ND | Nippondenso | 107 |
| 0-124-525-109 | 1-2685-00BO | Bosch | 3 | 028000-743 | 2-2710-ND-2 | Nippondenso | 101 |
| 0-124-615-019 | 1-2589-01BO | Bosch | 3 | 028000-779 | 2-1193-ND | Nippondenso | 101 |
| 0-124-615-033 | 1-2589-01BO | Bosch | 3 | 028000-781 | 2-2106-ND | Nippondenso | 105 |
| 0-124-615-035 | 1-2589-01BO | Bosch | 3 | 028000-783 | 2-1960-ND | Nippondenso | 104 |
| 0-124-625-020 | 1-2852-01BO | Bosch | 3 | 028000-783 | 2-1960-ND-2 | Nippondenso | 104 |
| 0-130-450-032 | 82-6854 | Bosch | 113 | 028000-823 | 2-1737-ND | Nippondenso | 103 |
| 0-130-450-032 | 82-6854-1 | Bosch | 113 | 028000-840 | 2-1750-ND | Nippondenso | 103 |
| 0-130-450-036 | 82-6852 | Bosch | 119 | 028000-904 | 2-2265-ND | Nippondenso | 108 |
| 0-130-450-036 | 82-6852-1 | Bosch | 119 | 028000-976 | 2-2108-ND | Nippondenso | 106 |
| 0-130-450-036 | 82-6889 | Bosch | 120 | 028000-977 | 2-2709-ND-2 | Nippondenso | 110 |
| 0-130-450-047 | 82-6867 | Bosch | 121 | 0350-402-0113 | 2-2108-ND | Sawafuji | 106 |
| 0-130-450-047 | 82-6867-1 | Bosch | 121 | 0350-402-0210 | 2-2108-ND | Sawafuji | 106 |
| 0-130-450-081 | 82-6854 | Bosch | 113 | 0350-402-0211 | 2-2108-ND | Sawafuji | 106 |
| 0-130-450-081 | 82-6854-1 | Bosch | 113 | 0350-552-0338 | 2-2222-ND | Sawafuji | 106 |
| 013-154-11-02 | 1-2852-01BO | Mercedes | 3 | 0350-602-0118 | 2-2223-ND | Sawafuji | 106 |
| 013-154-13-02 | 1-2589-01BO | Mercedes | 3 | 0350-602-0261M | 2-2226-ND | Sawafuji | 107 |

CROSS REFERENCE

CROSS REFERENCE - REF# to CATALOG#

| Mfr. Part# | Catalog# | Mfr. Name | Pg. # | Mfr. Part# | Catalog# | Mfr. Name | Pg. # |
|---------------|-------------|---------------|-------|---------------|---------------|-------------|-------|
| 0350-702-0180 | 2-2224-ND | Sawafuji | 106 | 0-986-018-070 | 2-2362-BO | Bosch | 8 |
| 063324145010 | 1-2754-02LU | Marelli | 77 | 0-986-018-150 | 2-2298-BO | Bosch | 4 |
| 069-911-023F | 2-1946-BO | VW-Audi | 7 | 0-986-018-150 | 2-2458-LU | Bosch | 81 |
| 091295 | 1-2711-00BO | DAF | 2 | 0-986-018-150 | 2-2458-LU-1 | Bosch | 81 |
| 091295 | 1-2711-01BO | DAF | 2 | 0-986-018-160 | 2-2292-LU | Bosch | 80 |
| 09200321 | 82-6877 | Haldex-Barnes | 118 | 0-986-018-270 | 2-2355-BO | Bosch | 8 |
| 0-986-010-970 | 2-2680-BO | Bosch | 5 | 0-986-018-270 | 2-2355-BO-1 | Bosch | 8 |
| 0-986-010-990 | 50-9124-1 | Bosch | 7 | 0-986-018-290 | 2-1946-BO | Bosch | 7 |
| 0-986-011-040 | 50-9107 | Bosch | 6 | 0-986-018-370 | 2-2822-DR | Bosch | 40 |
| 0-986-011-140 | 50-9109-1 | Bosch | 6 | 0-986-030-072 | 3-1005-01LU | Bosch | 77 |
| 0-986-011-140 | 50-9124-1 | Bosch | 7 | 0-986-030-760 | 1-2762-01LU | Bosch | 77 |
| 0-986-011-160 | 2-2283-BO | Bosch | 4 | 0-986-030-761 | 1-2762-01LU | Bosch | 77 |
| 0-986-011-160 | 50-9108 | Bosch | 6 | 0-986-032-651 | 1-1112-01 | Bosch | 65 |
| 0-986-011-161 | 2-2283-BO | Bosch | 4 | 0-986-032-860 | 1-2754-02LU | Bosch | 77 |
| 0-986-011-161 | 50-9108 | Bosch | 6 | 0-986-033-830 | 1-2754-02LU | Bosch | 77 |
| 0-986-011-200 | 50-9109-1 | Bosch | 6 | 0-986-033-850 | 1-2754-02LU | Bosch | 77 |
| 0-986-011-200 | 50-9124-1 | Bosch | 7 | 0-986-034-400 | 1-2711-00BO | Bosch | 2 |
| 0-986-011-220 | 50-9101-1 | Bosch | 6 | 0-986-035-421 | 1-1111-02HI | Bosch | 64 |
| 0-986-011-220 | 50-9900 | Bosch | 49 | 0-986-035-451 | 1-2315-01 | Bosch | 68 |
| 0-986-011-221 | 50-9101-1 | Bosch | 6 | 0-986-036-240 | 1-2614-01VA | Bosch | 112 |
| 0-986-011-240 | 50-9100-1 | Bosch | 5 | 0-986-036-241 | 1-2614-01VA | Bosch | 112 |
| 0-986-011-270 | 50-9110-1 | Bosch | 7 | 0-986-036-641 | 1-2119-11ND | Bosch | 98 |
| 0-986-011-310 | 2-2283-BO | Bosch | 4 | 0-986-036-641 | 1-2119-11ND-9 | Bosch | 98 |
| 0-986-011-310 | 50-9108 | Bosch | 6 | 0-986-036-800 | 1-2435-01BO | Bosch | 73 |
| 0-986-011-311 | 2-2283-BO | Bosch | 4 | 0-986-036-800 | 1-2851-01ND | Bosch | 100 |
| 0-986-011-330 | 50-9122-1 | Bosch | 7 | 0-986-037-271 | 1-2436-01ND | Bosch | 98 |
| 0-986-011-331 | 50-9122-1 | Bosch | 7 | 0-986-037-410 | 1-2711-00BO | Bosch | 2 |
| 0-986-011-340 | 2-2284-BO | Bosch | 4 | 0-986-037-770 | 1-2711-00BO | Bosch | 2 |
| 0-986-011-360 | 2-2297-BO | Bosch | 4 | 0-986-037-770 | 1-2711-01BO | Bosch | 2 |
| 0-986-011-460 | 50-9115 | Bosch | 7 | 0-986-039-340 | 1-2614-01VA | Bosch | 112 |
| 0-986-011-490 | 50-9117 | Bosch | 7 | 0-986-039-790 | 1-2711-00BO | Bosch | 2 |
| 0-986-011-510 | 50-9117 | Bosch | 7 | 0-986-040-201 | 1-2741-01VA | Bosch | 112 |
| 0-986-011-570 | 50-9117 | Bosch | 7 | 0-986-040-260 | 1-2711-00BO | Bosch | 2 |
| 0-986-011-580 | 50-9115 | Bosch | 7 | 0-986-040-280 | 1-2344-00BO | Bosch | 2 |
| 0-986-012-061 | 2-1682-ND | Bosch | 100 | 0-986-040-290 | 1-2237-00BO | Bosch | 2 |
| 0-986-012-420 | 2-1803-BO-2 | Bosch | 4 | 0-986-040-511 | 1-2479-01MI | Bosch | 84 |
| 0-986-012-470 | 2-2687-LU | Bosch | 81 | 0-986-041-090 | 1-2711-00BO | Bosch | 2 |
| 0-986-012-670 | 2-2325-BO | Bosch | 5 | 0-986-041-530 | 1-2768-01BO | Bosch | 3 |
| 0-986-012-670 | 50-9101-1 | Bosch | 6 | 0-986-041-580 | 1-2711-00BO | Bosch | 2 |
| 0-986-012-671 | 2-2325-BO | Bosch | 5 | 0-986-043-910 | 1-2589-01BO | Bosch | 3 |
| 0-986-012-671 | 50-9101-1 | Bosch | 6 | 0-986-043-913 | 1-2589-01BO | Bosch | 3 |
| 0-986-012-700 | 2-2325-BO | Bosch | 5 | 0-986-044-571 | 1-2754-02LU | Bosch | 77 |
| 0-986-012-720 | 50-9105-1 | Bosch | 6 | 0-986-044-591 | 1-2762-01LU | Bosch | 77 |
| 0-986-012-831 | 2-1728-MI | Bosch | 85 | 0-986-044-601 | 1-2619-01LU | Bosch | 76 |
| 0-986-012-831 | 2-2706-MI | Bosch | 86 | 0-986-052-090 | 2-2300-LU | Bosch | 78 |
| 0-986-012-931 | 2-1740-MI | Bosch | 86 | 0-986-052-090 | 2-2300-LU-1 | Bosch | 78 |
| 0-986-012-931 | 2-1741-1 | Bosch | 86 | 0R1699 | 20-131-1 | Caterpillar | 18 |
| 0-986-013-150 | 2-1193-ND | Bosch | 101 | 0R2415 | 20-178-1 | Caterpillar | 17 |
| 0-986-013-480 | 50-9100-1 | Bosch | 5 | 0R2793 | 20-125-1 | Caterpillar | 17 |
| 0-986-013-490 | 2-2297-BO | Bosch | 4 | 100211-007 | 1-2236-10ND | Nippondenso | 97 |
| 0-986-013-730 | 50-9117 | Bosch | 7 | 100211-008 | 1-2236-10ND | Nippondenso | 97 |
| 0-986-013-770 | 2-2299-BO | Bosch | 5 | 100211-028 | 1-2236-10ND | Nippondenso | 97 |
| 0-986-014-151 | 2-1727-MI | Bosch | 85 | 100211-029 | 1-2236-10ND | Nippondenso | 97 |
| 0-986-014-251 | 2-1193-ND | Bosch | 101 | 100211-161 | 1-2436-01ND | Nippondenso | 98 |
| 0-986-014-730 | 2-1803-BO-2 | Bosch | 4 | 100211-163 | 1-2436-01ND | Nippondenso | 98 |
| 0-986-014-740 | 2-1803-BO-2 | Bosch | 4 | 100211-164 | 1-2436-01ND | Nippondenso | 98 |
| 0-986-014-910 | 50-9115 | Bosch | 7 | 100211-166 | 1-2119-11ND | Nippondenso | 98 |
| 0-986-015-040 | 2-2303-LU | Bosch | 80 | 100211-166 | 1-2119-11ND-9 | Nippondenso | 98 |
| 0-986-015-040 | 2-2707-BO-2 | Bosch | 5 | 100211-167 | 1-2476-01ND | Nippondenso | 99 |
| 0-986-015-331 | 2-2238-ND | Bosch | 107 | 100211-400 | 1-1946-01ND | Nippondenso | 97 |
| 0-986-015-420 | 2-1946-BO | Bosch | 7 | 100211-410 | 1-2822-01ND-2 | Nippondenso | 99 |
| 0-986-015-680 | 50-104-1 | Bosch | 41 | 100211-452 | 1-2336-01ND | Nippondenso | 98 |
| 0-986-015-680 | 50-104-2 | Bosch | 41 | 100211-452 | 1-2336-01ND-9 | Nippondenso | 98 |
| 0-986-015-680 | 50-111 | Bosch | 43 | 100211-454 | 1-2132-01ND | Nippondenso | 98 |
| 0-986-015-680 | 50-111-1 | Bosch | 43 | 100211-454 | 1-2132-01ND-2 | Nippondenso | 98 |
| 0-986-016-141 | 2-2638 | Bosch | 93 | 100211-462 | 1-2119-11ND | Nippondenso | 98 |
| 0-986-016-520 | 50-9117 | Bosch | 7 | 100211-463 | 1-2119-11ND | Nippondenso | 98 |
| 0-986-017-240 | 2-2770-NK | Bosch | 94 | 100211-464 | 1-2477-01ND | Nippondenso | 99 |
| 0-986-017-260 | 2-2355-BO | Bosch | 8 | 100211-465 | 1-2478-01ND | Nippondenso | 99 |
| 0-986-017-260 | 2-2355-BO-1 | Bosch | 8 | 100211-469 | 1-2436-01ND | Nippondenso | 98 |
| 0-986-017-430 | 2-1946-BO | Bosch | 8 | 100211-603 | 1-2851-01ND | Nippondenso | 100 |
| 0-986-017-490 | 2-2463-BO | Bosch | 8 | 100211-605 | 1-2851-01ND | Nippondenso | 100 |

CROSS REFERENCE

CROSS REFERENCE - REF# to CATALOG#

| Mfr. Part No. | Catalog No. | Mfr. Name | Pg. # | Mfr. Part No. | Catalog No. | Mfr. Name | Pg. # |
|---------------|---------------|----------------|-------|---------------|-------------|-------------|-------|
| 100211-693 | 1-2439-01ND | Nippondenso | .98 | 103-239C | 2-1554-MI | PIC | .85 |
| 100211-697 | 1-2821-01ND-2 | Nippondenso | .99 | 103-239C | 2-1554-MI-1 | PIC | .85 |
| 100213-126 | 1-2456-01ND | Nippondenso | .99 | 103-242 | 2-1612-MI | PIC | .88 |
| 1005045 | 1-2571-00DR | Caterpillar | .16 | 103-242 | 2-1612-MI-2 | PIC | .88 |
| 1005045 | 20-121-1 | Caterpillar | .16 | 103-305 | 2-1963-MI | PIC | .89 |
| 1005047 | 20-121-1 | Caterpillar | .16 | 103-306 | 2-2103-MI | PIC | .90 |
| 1009633 | 82-6880 | Allis-Chalmers | .117 | 103-306A | 2-2103-MI | PIC | .90 |
| 101211-248 | 1-2436-01ND | Nippondenso | .98 | 103-307 | 2-2220-MI | PIC | .90 |
| 101211-8380 | 1-2304-00DR-1 | Nippondenso | .20 | 103-309 | 2-2024-MI | PIC | .89 |
| 101211-858 | 1-2823-01ND-2 | Nippondenso | .100 | 103-313 | 50-103-1 | PIC | .41 |
| 101-220B | 2-2355-BO | PIC | .8 | 103-313 | 50-103-2 | PIC | .40 |
| 101-220B | 2-2355-BO-1 | PIC | .8 | 103-330 | 2-2569-MI | PIC | .93 |
| 101-220E | 2-2355-BO | PIC | .8 | 103-331 | 2-1780-MI | PIC | .88 |
| 101-220E | 2-2355-BO-1 | PIC | .8 | 103-338 | 2-1747-MI | PIC | .91 |
| 10-159 | 20-412 | Motorola | .75 | 103-339 | 2-1748-MI-1 | PIC | .92 |
| 1017191 | 2-1727-MI | Towmotor | .85 | 103-340 | 2-1254-MI-2 | PIC | .87 |
| 10-225 | 20-412 | Motorola | .75 | 103-345 | 2-1963-MI | PIC | .89 |
| 102-308 | 50-9105-1 | PIC | .6 | 103-352 | 2-1780-MI | PIC | .88 |
| 102-308A | 50-9105-1 | PIC | .6 | 103-352A | 2-1780-MI | PIC | .88 |
| 102-309 | 50-9122-1 | PIC | .7 | 103-352B | 2-2227-MI | PIC | .91 |
| 102-310 | 2-2283-BO | PIC | .4 | 103-352B | 2-2227-MI-2 | PIC | .91 |
| 102-310A | 2-2283-BO | PIC | .4 | 103-354 | 2-1913-MI-1 | PIC | .89 |
| 102-311 | 50-9101-1 | PIC | .6 | 103-354B | 2-1913-MI-1 | PIC | .89 |
| 102-311A | 50-9101-1 | PIC | .6 | 103-355 | 2-2092-MI | PIC | .89 |
| 102-312 | 50-9101-1 | PIC | .6 | 103-355A | 2-2092-MI | PIC | .89 |
| 102-313 | 2-2325-BO | PIC | .5 | 103-363 | 2-2094-MI | PIC | .90 |
| 102-324 | 2-2283-BO | PIC | .4 | 103-366 | 2-2094-MI | PIC | .90 |
| 102-325 | 2-2284-BO | PIC | .4 | 103-366A | 2-2094-MI | PIC | .90 |
| 102-330 | 2-2325-BO | PIC | .5 | 103-367 | 2-2228-MI | PIC | .91 |
| 102-335 | 50-9101-1 | PIC | .6 | 103-370 | 2-2229-MI | PIC | .91 |
| 102-336 | 50-9108 | PIC | .6 | 103-373 | 2-2229-MI | PIC | .91 |
| 103-073 | 2-2093-MI | PIC | .90 | 103-374 | 2-2102-MI | PIC | .90 |
| 103-085 | 2-1996-MI | PIC | .92 | 103-375 | 2-2087-MI | PIC | .89 |
| 103-140 | 2-1741-1 | PIC | .86 | 103-375 | 2-2087-MI-1 | PIC | .89 |
| 103-140A | 2-1741-1 | PIC | .86 | 103-375A | 2-2087-MI | PIC | .89 |
| 103-141 | 2-1740-MI | PIC | .86 | 103-375A | 2-2087-MI-1 | PIC | .89 |
| 103-142 | 2-1740-MI | PIC | .86 | 103-384 | 2-2086-MI | PIC | .92 |
| 103-142A | 2-1740-MI | PIC | .86 | 103-404 | 2-2091-MI | PIC | .89 |
| 103-142B | 2-1740-MI | PIC | .86 | 103-450 | 2-2103-MI | PIC | .90 |
| 103-143 | 2-1729-MI | PIC | .85 | 103-5047 | 2-2725-MI | PIC | .93 |
| 103-144 | 2-1728-MI | PIC | .85 | 103-5048 | 2-2697-MI | PIC | .93 |
| 103-144 | 2-2706-MI | PIC | .86 | 103-5070 | 2-2824-MI | PIC | .92 |
| 103-145 | 2-1727-MI | PIC | .85 | 103-508 | 2-2638 | PIC | .93 |
| 103-148 | 2-2089-MI | PIC | .86 | 103-508A | 2-2638 | PIC | .93 |
| 103-157 | 2-2088-MI | PIC | .86 | 1038008 | 1-2392-01MI | Caterpillar | .84 |
| 103-180 | 2-1444-MI | PIC | .92 | 1039827 | 2-2102-MI | Caterpillar | .90 |
| 103-180 | 2-1444-MI-9 | PIC | .92 | 104-121 | 2-1741-1 | PIC | .86 |
| 103-180A | 2-1444-MI | PIC | .92 | 104-124 | 2-1724-HI-1 | PIC | .68 |
| 103-180A | 2-1444-MI-9 | PIC | .92 | 104-124A | 2-1724-HI-1 | PIC | .68 |
| 103-180B | 2-2698-MI | PIC | .93 | 104-142 | 2-2007-HI | PIC | .69 |
| 103-186 | 2-1728-MI | PIC | .85 | 104-147 | 2-1855-HI | PIC | .69 |
| 103-186 | 2-1728-MI-3 | PIC | .92 | 104-160 | 2-1736-HI-1 | PIC | .68 |
| 103-192 | 2-1727-MI | PIC | .85 | 104-209 | 2-2014-HI | PIC | .70 |
| 103-198 | 2-2308-MD | PIC | .83 | 104219A2 | 2-2286-DR | IHC | .43 |
| 103-206 | 2-2652-MI | PIC | .91 | 104221A2 | 2-2287-DR | IHC | .44 |
| 103-207 | 2-2101-MI | PIC | .90 | 104-228 | 2-1734-HI | PIC | .70 |
| 103-208 | 2-1728-MI-3 | PIC | .92 | 104-228A | 2-1734-HI | PIC | .70 |
| 103-209 | 2-1996-MI | PIC | .92 | 104-229 | 2-2037-HI | PIC | .70 |
| 103-230 | 2-1738-MI-1 | PIC | .86 | 104-229A | 2-2037-HI | PIC | .70 |
| 103-230A | 2-1738-MI-1 | PIC | .86 | 104-230 | 2-1734-HI | PIC | .70 |
| 103-232 | 2-1732-MI-1 | PIC | .88 | 104-231 | 2-2026-HI | PIC | .69 |
| 103-232A | 2-1732-MI-1 | PIC | .88 | 104-232 | 2-2301-LU | PIC | .78 |
| 103-233 | 2-1781-MI | PIC | .88 | 104-236 | 2-2014-HI | PIC | .70 |
| 103-234 | 2-1733-MI | PIC | .88 | 104-238 | 2-2317-HI | PIC | .69 |
| 103-235 | 2-1612-MI | PIC | .88 | 104-253A | 2-2006-HI | PIC | .70 |
| 103-235 | 2-1612-MI-2 | PIC | .88 | 104-253B | 2-2006-HI | PIC | .70 |
| 103-239 | 2-1554-MI | PIC | .85 | 104-254 | 2-2231-HI | PIC | .71 |
| 103-239 | 2-1554-MI-1 | PIC | .85 | 104-256 | 2-2264-HI | PIC | .72 |
| 103-239A | 2-1554-MI | PIC | .85 | 104-263B | 2-2235-HI | PIC | .71 |
| 103-239A | 2-1554-MI-1 | PIC | .85 | 104-267 | 2-2311-HI | PIC | .72 |
| 103-239B | 2-1554-MI | PIC | .85 | 104-267A | 2-2311-HI | PIC | .72 |
| 103-239B | 2-1554-MI-1 | PIC | .85 | 104-270 | 2-1493-DR | PIC | .47 |

CROSS REFERENCE

CROSS REFERENCE - REF# to CATALOG#

| Mfr. Part# | Catalog# | Mfr. Name | Pg. # | Mfr. Part# | Catalog# | Mfr. Name | Pg. # |
|------------|---------------|------------|-------|------------|---------------|------------|-------|
| 104-272 | 2-1193-HI | PIC | 69 | 10459050 | 1-2299-00DR | Delco-Remy | 13 |
| 104-273 | 2-2012-HI | PIC | 70 | 10459051 | 1-1918-00DR | Delco-Remy | 12 |
| 104-274 | 2-1776-HI | PIC | 70 | 10459051 | 1-2299-00DR | Delco-Remy | 13 |
| 104-274A | 2-1776-HI | PIC | 70 | 10459053 | 1-2334-00DR | Delco-Remy | 14 |
| 104-274C | 2-1776-HI | PIC | 70 | 10459053 | 1-2334-00DR-3 | Delco-Remy | 14 |
| 104-274D | 2-1776-HI | PIC | 70 | 10459057 | 20-132-1 | Delco-Remy | 18 |
| 104-277 | 2-2737-HI-2 | PIC | 69 | 10459058 | 20-1163-1 | Delco-Remy | 19 |
| 104-292 | 2-2321-HI | PIC | 72 | 10459063 | 1-2301-00DR | Delco-Remy | 17 |
| 104-294 | 2-2037-HI | PIC | 70 | 10459064 | 20-121-1 | Delco-Remy | 16 |
| 104-342 | 2-2319-HI | PIC | 72 | 10459065 | 1-2301-00DR | Delco-Remy | 17 |
| 104-345 | 2-2320-HI-1 | PIC | 72 | 10459067 | 1-2301-00DR | Delco-Remy | 17 |
| 104-345A | 2-2320-HI-1 | PIC | 72 | 10459068 | 1-2301-00DR | Delco-Remy | 17 |
| 104-350 | 2-2101-HI-2 | PIC | 71 | 10459073 | 1-2301-00DR | Delco-Remy | 17 |
| 104-350A | 2-2101-HI-2 | PIC | 71 | 10459074 | 1-2301-00DR | Delco-Remy | 17 |
| 104-350B | 2-2101-HI-2 | PIC | 71 | 10459075 | 20-119-1 | Delco-Remy | 16 |
| 104-351 | 2-2230-HI | PIC | 71 | 10459076 | 20-178-1 | Delco-Remy | 17 |
| 104-352 | 2-2100-HI | PIC | 71 | 10459077 | 20-119-1 | Delco-Remy | 16 |
| 104-356 | 2-2233-HI | PIC | 71 | 10459097 | 20-1163-1 | Delco-Remy | 19 |
| 104-390 | 2-2318-HI | PIC | 72 | 10459101 | 1-2301-00DR | Delco-Remy | 17 |
| 104-391 | 2-2758-HI-2 | PIC | 73 | 10459132 | 1-2301-00DR | Delco-Remy | 17 |
| 10455013 | 2-1470-DR | Delco-Remy | 47 | 10459141 | 1-2057-00DR-1 | Delco-Remy | 19 |
| 10455016 | 2-1413-DR | Delco-Remy | 47 | 10459142 | 1-2057-00DR-1 | Delco-Remy | 19 |
| 10455018 | 2-1493-DR | Delco-Remy | 47 | 10459143 | 1-2077-00DR-1 | Delco-Remy | 19 |
| 10455042 | 2-1470-DR | Delco-Remy | 47 | 10459144 | 1-2057-00DR-1 | Delco-Remy | 19 |
| 10455050 | 2-1470-DR | Delco-Remy | 47 | 10459144 | 1-2077-00DR-1 | Delco-Remy | 19 |
| 10455065 | 2-1796-DR | Delco-Remy | 47 | 10459145 | 1-2060-00DR-1 | Delco-Remy | 20 |
| 10455070 | 2-1470-DR | Delco-Remy | 47 | 10459152 | 20-124-1 | Delco-Remy | 17 |
| 10455300 | 2-1592-DR | Delco-Remy | 47 | 10459158 | 1-2297-00DR | Delco-Remy | 13 |
| 10455301 | 2-1604-DR | Delco-Remy | 48 | 10459159 | 1-2300-00DR | Delco-Remy | 14 |
| 10455305 | 2-1604-DR | Delco-Remy | 48 | 10459160 | 1-2334-00DR | Delco-Remy | 14 |
| 10455306 | 2-1607-DR | Delco-Remy | 48 | 10459160 | 1-2334-00DR-3 | Delco-Remy | 14 |
| 10455308 | 2-1604-DR | Delco-Remy | 48 | 10459180 | 1-2057-00DR-1 | Delco-Remy | 19 |
| 10455343 | 2-1604-DR | Delco-Remy | 48 | 10459181 | 1-2057-00DR-1 | Delco-Remy | 19 |
| 10456317 | 2-1474-DR-2 | Delco-Remy | 46 | 10459182 | 1-2077-00DR-1 | Delco-Remy | 19 |
| 10457194 | 50-194-1 | Delco-Remy | 37 | 10459183 | 1-2077-00DR-1 | Delco-Remy | 19 |
| 10459000 | 20-131-1 | Delco-Remy | 18 | 10459188 | 1-2044-00DR | Delco-Remy | 14 |
| 10459001 | 20-1163-1 | Delco-Remy | 19 | 10459189 | 1-2065-00DR | Delco-Remy | 15 |
| 10459002 | 20-132-1 | Delco-Remy | 18 | 10459189 | 1-2065-00DR-3 | Delco-Remy | 15 |
| 10459003 | 20-119-1 | Delco-Remy | 16 | 10459190 | 1-2065-00DR | Delco-Remy | 15 |
| 10459006 | 20-121-1 | Delco-Remy | 16 | 10459190 | 1-2065-00DR-3 | Delco-Remy | 15 |
| 10459007 | 20-178-1 | Delco-Remy | 17 | 10459191 | 1-2044-00DR | Delco-Remy | 14 |
| 10459008 | 20-1163-1 | Delco-Remy | 19 | 10459192 | 1-2065-00DR | Delco-Remy | 15 |
| 10459008 | 20-131-1 | Delco-Remy | 18 | 10459192 | 1-2065-00DR-3 | Delco-Remy | 15 |
| 10459009 | 20-133-1 | Delco-Remy | 18 | 10459193 | 1-2065-00DR | Delco-Remy | 15 |
| 10459011 | 20-178-1 | Delco-Remy | 17 | 10459193 | 1-2065-00DR-3 | Delco-Remy | 15 |
| 10459013 | 1-1915-00DR | Delco-Remy | 11 | 10459194 | 1-2077-00DR-1 | Delco-Remy | 19 |
| 10459013 | 1-2297-00DR | Delco-Remy | 13 | 10459195 | 1-2057-00DR-1 | Delco-Remy | 19 |
| 10459013 | 1-2300-00DR | Delco-Remy | 14 | 10459196 | 1-2558-00DR-1 | Delco-Remy | 19 |
| 10459017 | 1-1915-00DR | Delco-Remy | 11 | 10459197 | 1-2060-00DR-1 | Delco-Remy | 20 |
| 10459017 | 1-2333-00DR | Delco-Remy | 14 | 10459198 | 1-2078-00DR-1 | Delco-Remy | 20 |
| 10459018 | 20-119-1 | Delco-Remy | 16 | 10459199 | 1-2680-00DR | Delco-Remy | 20 |
| 10459020 | 20-117-1 | Delco-Remy | 11 | 10459204 | 1-2154-00DR | Delco-Remy | 15 |
| 10459026 | 1-2291-00DR | Delco-Remy | 12 | 10459205 | 1-2280-00DR | Delco-Remy | 15 |
| 10459027 | 1-1916-00DR | Delco-Remy | 12 | 10459206 | 1-2078-00DR-1 | Delco-Remy | 20 |
| 10459028 | 1-1917-00DR | Delco-Remy | 12 | 10459215 | 1-2154-00DR | Delco-Remy | 15 |
| 10459036 | 1-1915-00DR | Delco-Remy | 11 | 10459216 | 1-2431-00DR-3 | Delco-Remy | 15 |
| 10459037 | 1-1915-00DR | Delco-Remy | 11 | 10459217 | 1-2280-00DR | Delco-Remy | 15 |
| 10459037 | 1-1918-00DR | Delco-Remy | 12 | 10459237 | 20-132-1 | Delco-Remy | 18 |
| 10459037 | 1-2300-00DR | Delco-Remy | 14 | 10459238 | 20-125-1 | Delco-Remy | 17 |
| 10459037 | 1-2333-00DR | Delco-Remy | 14 | 10459244 | 20-127-1 | Delco-Remy | 18 |
| 10459037 | 1-2334-00DR | Delco-Remy | 14 | 10459251 | 1-2558-00DR-1 | Delco-Remy | 19 |
| 10459037 | 1-2334-00DR-3 | Delco-Remy | 14 | 10459254 | 1-2280-00DR | Delco-Remy | 15 |
| 10459039 | 1-2300-00DR | Delco-Remy | 14 | 10459255 | 1-2154-00DR | Delco-Remy | 15 |
| 10459039 | 1-2333-00DR | Delco-Remy | 14 | 10459257 | 20-1163-1 | Delco-Remy | 19 |
| 10459040 | 1-2300-00DR | Delco-Remy | 14 | 10459258 | 20-1163-1 | Delco-Remy | 19 |
| 10459040 | 1-2333-00DR | Delco-Remy | 14 | 10459274 | 1-2571-00DR | Delco-Remy | 16 |
| 10459042 | 1-2333-00DR | Delco-Remy | 14 | 10459278 | 1-2304-00DR-1 | Delco-Remy | 20 |
| 10459043 | 1-2333-00DR | Delco-Remy | 14 | 10459285 | 1-2304-00DR-1 | Delco-Remy | 20 |
| 10459046 | 1-1916-00DR | Delco-Remy | 12 | 10459319 | 20-118-1 | Delco-Remy | 11 |
| 10459047 | 1-1915-00DR | Delco-Remy | 11 | 10459320 | 1-2428-00DR-3 | Delco-Remy | 15 |
| 10459047 | 1-1918-00DR | Delco-Remy | 12 | 10459321 | 1-2428-00DR-3 | Delco-Remy | 15 |
| 10459049 | 1-1917-00DR | Delco-Remy | 12 | 10459336 | 1-2334-00DR | Delco-Remy | 14 |

CROSS REFERENCE

CROSS REFERENCE - REF# to CATALOG#

| Mfr. Part No. | Catalog No. | Mfr. Name | Pg. # | Mfr. Part No. | Catalog No. | Mfr. Name | Pg. # |
|---------------|---------------|------------|-------|---------------|---------------|------------|-------|
| 10459336 | 1-2334-00DR-3 | Delco-Remy | 14 | 10461078 | 2-2471-DR | Delco-Remy | 41 |
| 10459360 | 1-2154-00DR | Delco-Remy | 15 | 10461080 | 50-151-3 | Delco-Remy | 42 |
| 10459372 | 1-2571-00DR | Delco-Remy | 16 | 10461081 | 50-194-1 | Delco-Remy | 37 |
| 10459447 | 1-2358-01HI | Delco-Remy | 66 | 10461082 | 2-1582-DR-1 | Delco-Remy | 34 |
| 10459461 | 1-2291-00DR | Delco-Remy | 12 | 10461089 | 50-162-1 | Delco-Remy | 36 |
| 10459469 | 1-2427-30DR | Delco-Remy | 11 | 10461090 | 2-2471-DR | Delco-Remy | 41 |
| 10459481 | 1-2662-00DR | Delco-Remy | 16 | 10461096 | 50-192-1 | Delco-Remy | 43 |
| 10459483 | 1-2663-00DR | Delco-Remy | 16 | 10461096 | 50-192-2 | Delco-Remy | 43 |
| 10459612 | 1-2563-00DR | Delco-Remy | 21 | 10461098 | 2-1584-DR-2 | Delco-Remy | 34 |
| 10461001 | 50-159-1 | Delco-Remy | 36 | 10461098 | 50-194-1 | Delco-Remy | 37 |
| 10461002 | 50-159-1 | Delco-Remy | 36 | 10461107 | 50-103-1 | Delco-Remy | 41 |
| 10461003 | 50-161-1 | Delco-Remy | 36 | 10461107 | 50-103-2 | Delco-Remy | 40 |
| 10461005 | 50-113-1 | Delco-Remy | 35 | 10461108 | 50-158-1 | Delco-Remy | 36 |
| 10461006 | 50-193-1 | Delco-Remy | 36 | 10461110 | 2-1582-DR-1 | Delco-Remy | 34 |
| 10461008 | 50-162-1 | Delco-Remy | 36 | 10461141 | 50-151-3 | Delco-Remy | 42 |
| 10461011 | 50-193-1 | Delco-Remy | 36 | 10461170 | 2-2206-DR-1 | Delco-Remy | 35 |
| 10461016 | 50-160-1 | Delco-Remy | 36 | 10461172 | 2-2471-DR | Delco-Remy | 41 |
| 10461017 | 50-160-1 | Delco-Remy | 36 | 10461209 | 2-1582-DR-1 | Delco-Remy | 34 |
| 10461018 | 50-160-1 | Delco-Remy | 36 | 10461211 | 2-2471-DR | Delco-Remy | 41 |
| 10461021 | 50-150-1 | Delco-Remy | 42 | 10461225 | 50-161-1 | Delco-Remy | 36 |
| 10461021 | 50-150-2 | Delco-Remy | 42 | 10461226 | 1-2304-00DR-1 | Delco-Remy | 20 |
| 10461024 | 50-151-1 | Delco-Remy | 42 | 10461228 | 2-2471-DR | Delco-Remy | 41 |
| 10461024 | 50-151-2 | Delco-Remy | 42 | 10461232 | 50-192-1 | Delco-Remy | 43 |
| 10461024 | 50-151-3 | Delco-Remy | 42 | 10461232 | 50-192-2 | Delco-Remy | 43 |
| 10461024 | 50-152-1 | Delco-Remy | 42 | 10461234 | 1-2060-00DR-1 | Delco-Remy | 20 |
| 10461024 | 50-152-2 | Delco-Remy | 42 | 10461234 | 1-2078-00DR-1 | Delco-Remy | 20 |
| 10461025 | 50-103-1 | Delco-Remy | 41 | 10461235 | 1-2291-00DR | Delco-Remy | 12 |
| 10461025 | 50-103-2 | Delco-Remy | 40 | 10461240 | 2-2472-DR | Delco-Remy | 41 |
| 10461025 | 50-152-1 | Delco-Remy | 42 | 10461270 | 2-2471-DR | Delco-Remy | 41 |
| 10461025 | 50-152-2 | Delco-Remy | 42 | 10461285 | 50-8420 | Delco-Remy | 31 |
| 10461028 | 50-192-1 | Delco-Remy | 43 | 10461303 | 50-159-1 | Delco-Remy | 36 |
| 10461028 | 50-192-2 | Delco-Remy | 43 | 10461328 | 50-150-1 | Delco-Remy | 42 |
| 10461030 | 50-151-1 | Delco-Remy | 42 | 10461328 | 50-150-2 | Delco-Remy | 42 |
| 10461030 | 50-151-2 | Delco-Remy | 42 | 10461334 | 2-2001-DR | Delco-Remy | 37 |
| 10461030 | 50-151-3 | Delco-Remy | 42 | 10461334 | 2-2350-DR | Delco-Remy | 39 |
| 10461031 | 50-152-1 | Delco-Remy | 42 | 10461334 | 2-2350-DR-2 | Delco-Remy | 38 |
| 10461031 | 50-152-2 | Delco-Remy | 42 | 10461341 | 50-152-1 | Delco-Remy | 42 |
| 10461032 | 50-150-1 | Delco-Remy | 42 | 10461341 | 50-152-2 | Delco-Remy | 42 |
| 10461032 | 50-150-2 | Delco-Remy | 42 | 10461345 | 50-152-1 | Delco-Remy | 42 |
| 10461033 | 50-153-1 | Delco-Remy | 43 | 10461345 | 50-152-2 | Delco-Remy | 42 |
| 10461033 | 50-153-2 | Delco-Remy | 43 | 10461357 | 50-152-1 | Delco-Remy | 42 |
| 10461038 | 50-153-1 | Delco-Remy | 43 | 10461357 | 50-152-2 | Delco-Remy | 42 |
| 10461038 | 50-153-2 | Delco-Remy | 43 | 10461382 | 50-111 | Delco-Remy | 43 |
| 10461039 | 50-159-1 | Delco-Remy | 36 | 10461382 | 50-111-1 | Delco-Remy | 43 |
| 10461042 | 2-2703-DR | Delco-Remy | 42 | 104613892 | 50-111 | Delco-Remy | 43 |
| 10461044 | 50-113-1 | Delco-Remy | 35 | 104613892 | 50-111-1 | Delco-Remy | 43 |
| 10461045 | 2-2899-DR | Delco-Remy | 40 | 10461398 | 50-150-1 | Delco-Remy | 42 |
| 10461045 | 50-104-1 | Delco-Remy | 41 | 10461398 | 50-150-2 | Delco-Remy | 42 |
| 10461045 | 50-104-2 | Delco-Remy | 41 | 10461414 | 50-150-1 | Delco-Remy | 42 |
| 10461045 | 50-108-1 | Delco-Remy | 41 | 10461414 | 50-150-2 | Delco-Remy | 42 |
| 10461045 | 50-108-2 | Delco-Remy | 41 | 10461415 | 50-153-1 | Delco-Remy | 43 |
| 10461046 | 50-100-1 | Delco-Remy | 40 | 10461415 | 50-153-2 | Delco-Remy | 43 |
| 10461046 | 50-100-2 | Delco-Remy | 40 | 10461443 | 50-8422 | Delco-Remy | 31 |
| 10461047 | 50-104-1 | Delco-Remy | 41 | 10461445 | 50-8403 | Delco-Remy | 29 |
| 10461047 | 50-104-2 | Delco-Remy | 41 | 10461446 | 50-8406-2 | Delco-Remy | 30 |
| 10461050 | 50-150-1 | Delco-Remy | 42 | 10461447 | 50-8406-2 | Delco-Remy | 30 |
| 10461050 | 50-150-2 | Delco-Remy | 42 | 10461448 | 50-8410 | Delco-Remy | 30 |
| 10461052 | 50-153-1 | Delco-Remy | 43 | 10461449 | 50-8410 | Delco-Remy | 30 |
| 10461052 | 50-153-2 | Delco-Remy | 43 | 10461450 | 50-8404 | Delco-Remy | 29 |
| 10461053 | 2-2703-DR | Delco-Remy | 42 | 10461451 | 50-8404 | Delco-Remy | 29 |
| 10461055 | 50-192-1 | Delco-Remy | 43 | 10461453 | 50-8433 | Delco-Remy | 33 |
| 10461055 | 50-192-2 | Delco-Remy | 43 | 10461459 | 50-8424 | Delco-Remy | 31 |
| 10461056 | 2-2473-DR | Delco-Remy | 43 | 10461460 | 50-8419 | Delco-Remy | 31 |
| 10461057 | 50-111 | Delco-Remy | 43 | 10461461 | 50-8418 | Delco-Remy | 30 |
| 10461057 | 50-111-1 | Delco-Remy | 43 | 10461463 | 50-8431 | Delco-Remy | 32 |
| 10461058 | 50-193-1 | Delco-Remy | 36 | 10461464 | 50-8432 | Delco-Remy | 32 |
| 10461066 | 2-1584-DR-2 | Delco-Remy | 34 | 10461465 | 50-8434 | Delco-Remy | 33 |
| 10461068 | 50-151-1 | Delco-Remy | 42 | 10461466 | 50-8437 | Delco-Remy | 33 |
| 10461068 | 50-151-2 | Delco-Remy | 42 | 10461469 | 50-8421 | Delco-Remy | 31 |
| 10461068 | 50-151-3 | Delco-Remy | 42 | 10461470 | 2-2770-NK | Delco-Remy | 94 |
| 10461069 | 50-158-1 | Delco-Remy | 36 | 10461471 | 50-8438 | Delco-Remy | 33 |
| 10461076 | 2-2471-DR | Delco-Remy | 41 | 10461474 | 2-2051-DR | Delco-Remy | 29 |

CROSS REFERENCE

CROSS REFERENCE - REF# to CATALOG#

| Mfr. Part# | Catalog# | Mfr. Name | Pg. # | Mfr. Part# | Catalog# | Mfr. Name | Pg. # |
|------------|-------------|------------|-------|------------|---------------|------------|-------|
| 10461483 | 50-8436 | Delco-Remy | 33 | 10463367 | 20-142-11-1 | Delco-Remy | 22 |
| 10461484 | 50-8423 | Delco-Remy | 31 | 10463389 | 20-1132-12-1 | Delco-Remy | 24 |
| 10461485 | 50-8417 | Delco-Remy | 30 | 10463393 | 20-1132-33-1 | Delco-Remy | 25 |
| 10461486 | 50-8421 | Delco-Remy | 31 | 10463397 | 20-110-2 | Delco-Remy | 10 |
| 10461487 | 50-8415 | Delco-Remy | 30 | 10463406 | 1-1802-21DR-1 | Delco-Remy | 25 |
| 10461525 | 2-2207-DR-1 | Delco-Remy | 35 | 10463407 | 1-1802-31DR-1 | Delco-Remy | 26 |
| 10461686 | 2-2569-MI | Delco-Remy | 93 | 10463408 | 1-1802-42DR-1 | Delco-Remy | 26 |
| 10461753 | 2-2347-DR-1 | Delco-Remy | 38 | 10463413 | 20-1132-12-1 | Delco-Remy | 24 |
| 10461753 | 2-2352-DR-1 | Delco-Remy | 39 | 10463414 | 20-152-11-1 | Delco-Remy | 23 |
| 10461754 | 2-2345-DR-1 | Delco-Remy | 38 | 10463415 | 20-1132-22-1 | Delco-Remy | 25 |
| 10461756 | 2-2348-DR | Delco-Remy | 38 | 10463417 | 20-1132-33-1 | Delco-Remy | 25 |
| 10461758 | 2-2349-DR | Delco-Remy | 38 | 10463418 | 20-1132-12-1 | Delco-Remy | 24 |
| 10461758 | 2-2349-DR-1 | Delco-Remy | 38 | 10463419 | 20-184-32 | Delco-Remy | 24 |
| 10461759 | 2-2364-DR | Delco-Remy | 39 | 10463421 | 20-1142-31-1 | Delco-Remy | 25 |
| 10461765 | 2-2391-DR | Delco-Remy | 34 | 10463422 | 20-1142-31-1 | Delco-Remy | 25 |
| 10461768 | 2-2377-DR | Delco-Remy | 37 | 10463423 | 20-1142-31-1 | Delco-Remy | 25 |
| 10461768 | 2-2377-DR-1 | Delco-Remy | 37 | 10463424 | 20-1132-22-1 | Delco-Remy | 25 |
| 10461769 | 2-2372-DR | Delco-Remy | 37 | 10463425 | 20-1132-33-1 | Delco-Remy | 25 |
| 10461770 | 2-2357-DR-1 | Delco-Remy | 34 | 10463443 | 1-1802-42DR-1 | Delco-Remy | 26 |
| 10461771 | 2-2704-DR-2 | Delco-Remy | 34 | 10463445 | 20-145-11-1 | Delco-Remy | 23 |
| 10461772 | 2-2389-DR | Delco-Remy | 34 | 10463529 | 20-189-11-1 | Delco-Remy | 24 |
| 10461773 | 2-2353-DR-1 | Delco-Remy | 39 | 10463622 | 20-142-11-1 | Delco-Remy | 22 |
| 10461777 | 2-2347-DR-1 | Delco-Remy | 38 | 10463631 | 1-1802-31DR-1 | Delco-Remy | 26 |
| 10463005 | 20-152-22-1 | Delco-Remy | 23 | 10463632 | 1-1802-21DR-1 | Delco-Remy | 25 |
| 10463006 | 20-152-22-1 | Delco-Remy | 23 | 10463636 | 20-1156-21 | Delco-Remy | 28 |
| 10463020 | 20-142-11-1 | Delco-Remy | 22 | 10463651 | 1-1995-21DR-1 | Delco-Remy | 26 |
| 10463021 | 20-142-11-1 | Delco-Remy | 22 | 10463652 | 1-1995-21DR-1 | Delco-Remy | 26 |
| 10463028 | 20-152-22-1 | Delco-Remy | 23 | 10463686 | 20-1156-21 | Delco-Remy | 28 |
| 10463034 | 20-142-11-1 | Delco-Remy | 22 | 10463687 | 1-2037-21DR | Delco-Remy | 27 |
| 10463038 | 20-152-32-1 | Delco-Remy | 24 | 10463688 | 1-2042-21DR-1 | Delco-Remy | 26 |
| 10463039 | 20-152-11-1 | Delco-Remy | 23 | 10463690 | 1-1995-21DR-1 | Delco-Remy | 26 |
| 10463044 | 20-145-31-1 | Delco-Remy | 23 | 10463692 | 20-1156-21 | Delco-Remy | 28 |
| 10463046 | 20-152-11-1 | Delco-Remy | 23 | 10463940 | 1-1995-22DR | Delco-Remy | 26 |
| 10463047 | 20-152-31-1 | Delco-Remy | 24 | 10464081 | 20-1156-21 | Delco-Remy | 28 |
| 10463048 | 20-152-31-1 | Delco-Remy | 24 | 10464082 | 1-2037-21DR | Delco-Remy | 27 |
| 10463049 | 20-142-32-1 | Delco-Remy | 22 | 10464084 | 1-2156-21DR-1 | Delco-Remy | 26 |
| 10463060 | 20-110-2 | Delco-Remy | 10 | 10464085 | 1-2175-31DR-1 | Delco-Remy | 27 |
| 10463072 | 20-124-1 | Delco-Remy | 17 | 10464090 | 1-2042-21DR-1 | Delco-Remy | 26 |
| 10463073 | 20-124-1 | Delco-Remy | 17 | 10464404 | 1-2197-21DR | Delco-Remy | 21 |
| 10463074 | 20-126-1 | Delco-Remy | 18 | 10464405 | 1-2419-21DR | Delco-Remy | 22 |
| 10463085 | 20-152-22-1 | Delco-Remy | 23 | 10464433 | 1-2156-21DR-1 | Delco-Remy | 26 |
| 10463089 | 20-152-22-1 | Delco-Remy | 23 | 10464438 | 1-2320-21DR | Delco-Remy | 21 |
| 10463098 | 20-145-21-1 | Delco-Remy | 23 | 10464443 | 1-2419-21DR | Delco-Remy | 22 |
| 10463105 | 20-152-11-1 | Delco-Remy | 23 | 10464451 | 1-2320-21DR | Delco-Remy | 21 |
| 10463110 | 20-145-21-1 | Delco-Remy | 23 | 10464453 | 1-2419-21DR | Delco-Remy | 22 |
| 10463111 | 20-145-21-1 | Delco-Remy | 23 | 10464455 | 1-2320-21DR | Delco-Remy | 21 |
| 10463123 | 20-145-31-1 | Delco-Remy | 23 | 10464456 | 1-2419-21DR | Delco-Remy | 22 |
| 10463140 | 20-152-32-1 | Delco-Remy | 24 | 10464457 | 1-1995-21DR-1 | Delco-Remy | 26 |
| 10463140 | 20-184-32 | Delco-Remy | 24 | 10464459 | 1-2415-41DR | Delco-Remy | 22 |
| 10463143 | 20-152-22-1 | Delco-Remy | 23 | 10464460 | 1-2418-41DR | Delco-Remy | 22 |
| 10463144 | 20-189-11-1 | Delco-Remy | 24 | 10464462 | 1-2398-11DR | Delco-Remy | 27 |
| 10463145 | 20-189-11-1 | Delco-Remy | 24 | 10464476 | 1-2419-21DR | Delco-Remy | 22 |
| 10463146 | 20-145-11-1 | Delco-Remy | 23 | 10-46-4476 | 1-2419-21DR | Saab | 22 |
| 10463147 | 20-145-11-1 | Delco-Remy | 23 | 10464481 | 1-2320-21DR | Delco-Remy | 21 |
| 10463152 | 20-175-11 | Delco-Remy | 27 | 10464483 | 1-2415-41DR | Delco-Remy | 22 |
| 10463153 | 20-175-11 | Delco-Remy | 27 | 10465001 | 2-1474-DR-2 | Delco-Remy | 46 |
| 10463163 | 20-142-11-1 | Delco-Remy | 22 | 10465009 | 2-1474-DR-2 | Delco-Remy | 46 |
| 10463164 | 20-145-21-1 | Delco-Remy | 23 | 10465013 | 2-1580-DR | Delco-Remy | 29 |
| 10463165 | 20-145-21-1 | Delco-Remy | 23 | 10465014 | 50-8402-2 | Delco-Remy | 29 |
| 10463179 | 20-152-31-1 | Delco-Remy | 24 | 10465015 | 50-8433 | Delco-Remy | 33 |
| 10463183 | 20-184-32 | Delco-Remy | 24 | 10465020 | 2-1493-DR | Delco-Remy | 47 |
| 10463185 | 20-152-11-1 | Delco-Remy | 23 | 10465026 | 50-8407 | Delco-Remy | 30 |
| 10463186 | 20-152-32-1 | Delco-Remy | 24 | 10465026 | 50-8420 | Delco-Remy | 31 |
| 10463197 | 20-1105-41 | Delco-Remy | 28 | 10465032 | 2-1413-DR | Delco-Remy | 47 |
| 10463198 | 20-1105-41 | Delco-Remy | 28 | 10465043 | 50-8407 | Delco-Remy | 30 |
| 10463205 | 20-152-32-1 | Delco-Remy | 24 | 10465043 | 50-8437 | Delco-Remy | 33 |
| 10463242 | 20-175-11 | Delco-Remy | 27 | 10465044 | 50-8405 | Delco-Remy | 29 |
| 10463245 | 20-145-21-1 | Delco-Remy | 23 | 10465044 | 50-8431 | Delco-Remy | 32 |
| 10463266 | 20-175-11 | Delco-Remy | 27 | 10465045 | 50-8406-2 | Delco-Remy | 30 |
| 10463299 | 20-1105-41 | Delco-Remy | 28 | 10465046 | 50-8406-2 | Delco-Remy | 30 |
| 10463300 | 20-1105-41 | Delco-Remy | 28 | 10465047 | 50-8410 | Delco-Remy | 30 |
| 10463336 | 20-175-11 | Delco-Remy | 27 | 10465048 | 50-8410 | Delco-Remy | 30 |

CROSS REFERENCE

CROSS REFERENCE - REF# to CATALOG#

| Mfr. Part No. | Catalog No. | Mfr. Name | Pg. # | Mfr. Part No. | Catalog No. | Mfr. Name | Pg. # |
|---------------|-------------|------------|-------|---------------|-------------|------------|-------|
| 10465049 | 50-8404 | Delco-Remy | 29 | 10478964 | 50-192-1 | Delco-Remy | 43 |
| 10465050 | 50-8404 | Delco-Remy | 29 | 10478964 | 50-192-2 | Delco-Remy | 43 |
| 10465053 | 2-1580-DR | Delco-Remy | 29 | 10478980 | 50-151-1 | Delco-Remy | 42 |
| 10465054 | 50-8402-2 | Delco-Remy | 29 | 10478980 | 50-151-2 | Delco-Remy | 42 |
| 10465057 | 50-8415 | Delco-Remy | 30 | 10478980 | 50-151-3 | Delco-Remy | 42 |
| 10465058 | 50-8403 | Delco-Remy | 29 | 10478992 | 50-150-1 | Delco-Remy | 42 |
| 10465065 | 2-1470-DR | Delco-Remy | 47 | 10478992 | 50-150-2 | Delco-Remy | 42 |
| 10465149 | 50-157-9 | Delco-Remy | 28 | 10478994 | 50-150-1 | Delco-Remy | 42 |
| 10465150 | 50-8428 | Delco-Remy | 32 | 10478994 | 50-150-2 | Delco-Remy | 42 |
| 10465151 | 50-8425 | Delco-Remy | 32 | 10478998 | 50-151-1 | Delco-Remy | 42 |
| 10465167 | 2-1690-DR-2 | Delco-Remy | 46 | 10478998 | 50-151-2 | Delco-Remy | 42 |
| 10465168 | 50-8402-2 | Delco-Remy | 29 | 10478998 | 50-151-3 | Delco-Remy | 42 |
| 10465211 | 50-8420 | Delco-Remy | 31 | 10479004 | 50-150-1 | Delco-Remy | 42 |
| 10465296 | 2-1580-DR | Delco-Remy | 29 | 10479004 | 50-150-2 | Delco-Remy | 42 |
| 10465314 | 50-8425 | Delco-Remy | 32 | 10479037 | 50-153-1 | Delco-Remy | 43 |
| 10465346 | 50-8426 | Delco-Remy | 32 | 10479037 | 50-153-2 | Delco-Remy | 43 |
| 10465349 | 50-8429 | Delco-Remy | 32 | 10479038 | 50-192-1 | Delco-Remy | 43 |
| 10465351 | 50-8429 | Delco-Remy | 32 | 10479038 | 50-192-2 | Delco-Remy | 43 |
| 10465365 | 50-8420 | Delco-Remy | 31 | 10479041 | 2-2471-DR | Delco-Remy | 41 |
| 10465375 | 2-1912-DR-2 | Delco-Remy | 46 | 10479052 | 50-150-1 | Delco-Remy | 42 |
| 10465385 | 2-2095-DR-2 | Delco-Remy | 46 | 10479052 | 50-150-2 | Delco-Remy | 42 |
| 10465389 | 2-1796-DR | Delco-Remy | 47 | 10479062 | 50-192-1 | Delco-Remy | 43 |
| 10465396 | 2-1470-DR | Delco-Remy | 47 | 10479062 | 50-192-2 | Delco-Remy | 43 |
| 10465401 | 50-8429 | Delco-Remy | 32 | 10479063 | 2-2471-DR | Delco-Remy | 41 |
| 10465402 | 50-8428 | Delco-Remy | 32 | 10479064 | 2-2471-DR | Delco-Remy | 41 |
| 10465420 | 50-8426 | Delco-Remy | 32 | 10479065 | 50-153-1 | Delco-Remy | 43 |
| 10465462 | 2-1954-DR-2 | Delco-Remy | 44 | 10479065 | 50-153-2 | Delco-Remy | 43 |
| 10465463 | 2-2054-DR-2 | Delco-Remy | 44 | 10479072 | 50-153-1 | Delco-Remy | 43 |
| 10465520 | 2-2112-DR-2 | Delco-Remy | 45 | 10479072 | 50-153-2 | Delco-Remy | 43 |
| 10465529 | 2-2735-ND-2 | Delco-Remy | 111 | 10479081 | 50-153-1 | Delco-Remy | 43 |
| 10465540 | 2-1526-ND | Delco-Remy | 102 | 10479081 | 50-153-2 | Delco-Remy | 43 |
| 10465548 | 2-2211-DR-2 | Delco-Remy | 45 | 10479082 | 50-192-1 | Delco-Remy | 43 |
| 10465550 | 2-2200-DR-2 | Delco-Remy | 45 | 10479082 | 50-192-2 | Delco-Remy | 43 |
| 10465554 | 2-1690-DR-2 | Delco-Remy | 46 | 10479104 | 2-2703-DR | Delco-Remy | 42 |
| 10465560 | 2-2200-DR-2 | Delco-Remy | 45 | 10479106 | 50-162-1 | Delco-Remy | 36 |
| 10465561 | 2-2211-DR-2 | Delco-Remy | 45 | 10479109 | 2-2472-DR | Delco-Remy | 41 |
| 10465577 | 2-2112-DR-2 | Delco-Remy | 45 | 10479110 | 50-153-1 | Delco-Remy | 43 |
| 10465578 | 2-2143-DR-2 | Delco-Remy | 45 | 10479110 | 50-153-2 | Delco-Remy | 43 |
| 10465579 | 2-2054-DR-2 | Delco-Remy | 44 | 10479112 | 50-153-1 | Delco-Remy | 43 |
| 104668 | 2-1526-ND | Versatile | 102 | 10479112 | 50-153-2 | Delco-Remy | 43 |
| 10469605 | 50-8418 | Delco-Remy | 30 | 10479113 | 50-153-1 | Delco-Remy | 43 |
| 10477080 | 20-110-2 | Delco-Remy | 10 | 10479113 | 50-153-2 | Delco-Remy | 43 |
| 10478803 | 50-150-1 | Delco-Remy | 42 | 10479117 | 50-150-1 | Delco-Remy | 42 |
| 10478803 | 50-150-2 | Delco-Remy | 42 | 10479117 | 50-150-2 | Delco-Remy | 42 |
| 10478804 | 50-150-1 | Delco-Remy | 42 | 10479126 | 50-111 | Delco-Remy | 43 |
| 10478804 | 50-150-2 | Delco-Remy | 42 | 10479126 | 50-111-1 | Delco-Remy | 43 |
| 10478806 | 50-194-1 | Delco-Remy | 37 | 10479150 | 50-153-1 | Delco-Remy | 43 |
| 10478809 | 2-2675-DR | Delco-Remy | 42 | 10479150 | 50-153-2 | Delco-Remy | 43 |
| 10478810 | 50-153-1 | Delco-Remy | 43 | 10479159 | 2-2471-DR | Delco-Remy | 41 |
| 10478810 | 50-153-2 | Delco-Remy | 43 | 10479162 | 50-150-1 | Delco-Remy | 42 |
| 10478813 | 2-2473-DR | Delco-Remy | 43 | 10479162 | 50-150-2 | Delco-Remy | 42 |
| 10478818 | 2-2472-DR | Delco-Remy | 41 | 10479164 | 50-151-1 | Delco-Remy | 42 |
| 10478831 | 50-161-1 | Delco-Remy | 36 | 10479164 | 50-151-2 | Delco-Remy | 42 |
| 10478835 | 50-150-1 | Delco-Remy | 42 | 10479164 | 50-151-3 | Delco-Remy | 42 |
| 10478835 | 50-150-2 | Delco-Remy | 42 | 10479175 | 50-160-1 | Delco-Remy | 36 |
| 10478853 | 2-2474-DR | Delco-Remy | 43 | 10479185 | 50-153-1 | Delco-Remy | 43 |
| 10478877 | 2-2473-DR | Delco-Remy | 43 | 10479185 | 50-153-2 | Delco-Remy | 43 |
| 10478879 | 50-111 | Delco-Remy | 43 | 10479191 | 50-150-1 | Delco-Remy | 42 |
| 10478879 | 50-111-1 | Delco-Remy | 43 | 10479191 | 50-150-2 | Delco-Remy | 42 |
| 10478885 | 50-111 | Delco-Remy | 43 | 10479277 | 50-153-1 | Delco-Remy | 43 |
| 10478885 | 50-111-1 | Delco-Remy | 43 | 10479277 | 50-153-2 | Delco-Remy | 43 |
| 10478890 | 2-2206-DR-1 | Delco-Remy | 35 | 10479339 | 50-111 | Delco-Remy | 43 |
| 10478904 | 2-2473-DR | Delco-Remy | 43 | 10479339 | 50-111-1 | Delco-Remy | 43 |
| 10478931 | 50-150-1 | Delco-Remy | 42 | 10479600 | 50-8424 | Delco-Remy | 31 |
| 10478931 | 50-150-2 | Delco-Remy | 42 | 10479604 | 50-8419 | Delco-Remy | 31 |
| 10478934 | 50-150-1 | Delco-Remy | 42 | 10479605 | 50-8418 | Delco-Remy | 30 |
| 10478934 | 50-150-2 | Delco-Remy | 42 | 10479606 | 50-8441 | Delco-Remy | 33 |
| 10478936 | 50-150-1 | Delco-Remy | 42 | 10479607 | 50-8431 | Delco-Remy | 32 |
| 10478936 | 50-150-2 | Delco-Remy | 42 | 10479608 | 50-8432 | Delco-Remy | 32 |
| 10478953 | 2-2470-DR | Delco-Remy | 35 | 10479611 | 50-8433 | Delco-Remy | 33 |
| 10478963 | 50-153-1 | Delco-Remy | 43 | 10479613 | 50-8426 | Delco-Remy | 32 |
| 10478963 | 50-153-2 | Delco-Remy | 43 | 10479614 | 50-8428 | Delco-Remy | 32 |

CROSS REFERENCE

CROSS REFERENCE - REF# to CATALOG#

| Mfr. Part# | Catalog# | Mfr. Name | Pg. # | Mfr. Part# | Catalog# | Mfr. Name | Pg. # |
|------------|---------------|------------|-------|------------|---------------|-------------|-------|
| 10479615 | 50-8425 | Delco-Remy | 32 | 10480254 | 1-2156-21DR-1 | Delco-Remy | 26 |
| 10479616 | 50-8434 | Delco-Remy | 33 | 10480255 | 20-1156-21 | Delco-Remy | 28 |
| 10479617 | 50-8437 | Delco-Remy | 33 | 10480267 | 1-2037-21DR | Delco-Remy | 27 |
| 10479618 | 50-8425 | Delco-Remy | 32 | 10480288 | 1-2398-11DR | Delco-Remy | 27 |
| 10479621 | 50-8407 | Delco-Remy | 30 | 10480326 | 1-2320-21DR | Delco-Remy | 21 |
| 10479621 | 50-8437 | Delco-Remy | 33 | 10480388 | 1-2320-21DR | Delco-Remy | 21 |
| 10479623 | 50-8421 | Delco-Remy | 31 | 10480390 | 1-2419-21DR | Delco-Remy | 22 |
| 10479624 | 50-8420 | Delco-Remy | 31 | 10480476 | 1-2320-21DR | Delco-Remy | 21 |
| 10479625 | 50-8425 | Delco-Remy | 32 | 10495382 | 20-102-1 | Delco-Remy | 10 |
| 10479626 | 2-2770-NK | Delco-Remy | 94 | 10495396 | 2-1493-DR | Delco-Remy | 47 |
| 10479628 | 50-8438 | Delco-Remy | 33 | 10496871 | 2-1592-DR | Delco-Remy | 47 |
| 10479634 | 2-2051-DR | Delco-Remy | 29 | 10496873 | 2-1604-DR | Delco-Remy | 48 |
| 10479638 | 50-8425 | Delco-Remy | 32 | 10496873 | 2-1607-DR | Delco-Remy | 48 |
| 10479641 | 50-8425 | Delco-Remy | 32 | 10496874 | 2-1604-DR | Delco-Remy | 48 |
| 10479650 | 2-2770-NK | Delco-Remy | 94 | 10496877 | 2-1601-DR-2 | Delco-Remy | 48 |
| 10479801 | 20-145-21-1 | Delco-Remy | 23 | 10496879 | 2-1598-DR-2 | Delco-Remy | 48 |
| 10479802 | 20-145-21-1 | Delco-Remy | 23 | 10496882 | 50-157-9 | Delco-Remy | 28 |
| 10479806 | 20-142-11-1 | Delco-Remy | 22 | 10496883 | 50-157-9 | Delco-Remy | 28 |
| 10479807 | 20-145-21-1 | Delco-Remy | 23 | 10497079 | 20-110-2 | Delco-Remy | 10 |
| 10479808 | 20-145-21-1 | Delco-Remy | 23 | 10497080 | 20-110-2 | Delco-Remy | 10 |
| 10479874 | 20-152-32-1 | Delco-Remy | 24 | 10497081 | 20-110-2 | Delco-Remy | 10 |
| 10479881 | 1-1802-21DR-1 | Delco-Remy | 25 | 10497083 | 20-113-1 | Delco-Remy | 10 |
| 10479883 | 20-152-32-1 | Delco-Remy | 24 | 10497120 | 20-152-22-1 | Delco-Remy | 23 |
| 10479915 | 20-116-1 | Delco-Remy | 10 | 10497121 | 20-152-22-1 | Delco-Remy | 23 |
| 10479920 | 20-142-11-1 | Delco-Remy | 22 | 10497177 | 20-124-1 | Delco-Remy | 17 |
| 10479921 | 20-145-21-1 | Delco-Remy | 23 | 10497396 | 2-1493-DR | Delco-Remy | 47 |
| 10479922 | 20-145-21-1 | Delco-Remy | 23 | 105-200 | 50-9900 | PIC | 49 |
| 10479924 | 20-113-1 | Delco-Remy | 10 | 1052813 | 1-2344-00BO | Caterpillar | 2 |
| 10479925 | 20-113-1 | Delco-Remy | 10 | 106-027 | 82-7850 | PIC | 120 |
| 10479926 | 20-113-1 | Delco-Remy | 10 | 106-317 | 82-7871 | PIC | 123 |
| 10479927 | 20-113-1 | Delco-Remy | 10 | 106-650 | 82-7859 | PIC | 120 |
| 10479929 | 20-113-1 | Delco-Remy | 10 | 10710 | 82-7852 | Lester | 120 |
| 10479930 | 20-113-1 | Delco-Remy | 10 | 10711 | 82-7859 | Lester | 120 |
| 10479974 | 20-142-11-1 | Delco-Remy | 22 | 10715 | 82-6880 | Lester | 117 |
| 10479976 | 20-1138-11-1 | Delco-Remy | 25 | 10716 | 82-6869 | Lester | 115 |
| 10479981 | 1-1802-21DR-1 | Delco-Remy | 25 | 10716 | 82-6869-1 | Lester | 115 |
| 10479984 | 1-1802-31DR-1 | Delco-Remy | 26 | 10716 | 82-6874 | Lester | 116 |
| 10479993 | 20-145-31-1 | Delco-Remy | 23 | 10718 | 82-6888 | Lester | 117 |
| 10480017 | 1-1802-42DR-1 | Delco-Remy | 26 | 10721 | 82-6864 | Lester | 115 |
| 10480022 | 20-1105-41 | Delco-Remy | 28 | 10724 | 82-6866 | Lester | 121 |
| 10480023 | 20-1105-41 | Delco-Remy | 28 | 10725 | 82-6852 | Lester | 119 |
| 10480058 | 20-104-1 | Delco-Remy | 10 | 10725 | 82-6852-1 | Lester | 119 |
| 10480069 | 20-1132-12-1 | Delco-Remy | 24 | 10725 | 82-6889 | Lester | 120 |
| 10480072 | 1-1802-42DR-1 | Delco-Remy | 26 | 10727 | 82-6875 | Lester | 118 |
| 10480082 | 20-1132-12-1 | Delco-Remy | 24 | 10728 | 82-6860 | Lester | 114 |
| 10480084 | 20-1132-22-1 | Delco-Remy | 25 | 10728 | 82-6860-1 | Lester | 114 |
| 10480086 | 20-1132-33-1 | Delco-Remy | 25 | 10728 | 82-6860-2 | Lester | 114 |
| 10480087 | 20-1132-12-1 | Delco-Remy | 24 | 10728 | 82-6860-3 | Lester | 114 |
| 10480088 | 20-184-32 | Delco-Remy | 24 | 10732 | 82-6890 | Lester | 122 |
| 10480090 | 20-1142-31-1 | Delco-Remy | 25 | 10735 | 82-6885 | Lester | 117 |
| 10480091 | 20-1142-31-1 | Delco-Remy | 25 | 10735 | 82-7851 | Lester | 118 |
| 10480092 | 20-1142-31-1 | Delco-Remy | 25 | 10736 | 82-6885 | Lester | 117 |
| 10480093 | 20-189-11-1 | Delco-Remy | 24 | 10736 | 82-7851 | Lester | 118 |
| 10480094 | 20-1132-22-1 | Delco-Remy | 25 | 10739 | 82-7861 | Lester | 118 |
| 10480097 | 20-1132-33-1 | Delco-Remy | 25 | 10746 | 82-6867 | Lester | 121 |
| 10480099 | 20-1132-33-1 | Delco-Remy | 25 | 10746 | 82-6867-1 | Lester | 121 |
| 10480130 | 20-1156-21 | Delco-Remy | 28 | 10747 | 82-6865 | Lester | 121 |
| 10480133 | 20-1156-21 | Delco-Remy | 28 | 10748 | 82-6867 | Lester | 121 |
| 10480156 | 1-2037-21DR | Delco-Remy | 27 | 10748 | 82-6867-1 | Lester | 121 |
| 10480167 | 1-1995-21DR-1 | Delco-Remy | 26 | 10750 | 82-6875 | Lester | 118 |
| 10480168 | 1-1995-21DR-1 | Delco-Remy | 26 | 10751 | 82-6854 | Lester | 113 |
| 10480170 | 1-2042-21DR-1 | Delco-Remy | 26 | 10751 | 82-6854-1 | Lester | 113 |
| 10480187 | 1-1802-31DR-1 | Delco-Remy | 26 | 10752 | 82-6854 | Lester | 113 |
| 10480188 | 1-1802-21DR-1 | Delco-Remy | 25 | 10752 | 82-6854-1 | Lester | 113 |
| 10480189 | 1-1802-42DR-1 | Delco-Remy | 26 | 10752 | 82-6873 | Lester | 116 |
| 10480190 | 1-1802-42DR-1 | Delco-Remy | 26 | 10753 | 82-6854 | Lester | 113 |
| 10480198 | 1-1995-21DR-1 | Delco-Remy | 26 | 10753 | 82-6854-1 | Lester | 113 |
| 10480206 | 20-1156-21 | Delco-Remy | 28 | 10753 | 82-6873 | Lester | 116 |
| 10480229 | 1-2197-21DR | Delco-Remy | 21 | 108-278 | 2-2294-VA | PIC | 112 |
| 10480234 | 1-2419-21DR | Delco-Remy | 22 | 108-302 | 2-2307-MD | PIC | 83 |
| 10480251 | 1-2156-21DR-1 | Delco-Remy | 26 | 108-303 | 2-2306-MD | PIC | 83 |
| 10480252 | 1-2175-31DR-1 | Delco-Remy | 27 | 1092361 | 2-2285-BO | Caterpillar | 4 |

CROSS REFERENCE

CROSS REFERENCE - REF# to CATALOG#

| Mfr. Part No. | Catalog No. | Mfr. Name | Pg. # | Mfr. Part No. | Catalog No. | Mfr. Name | Pg. # |
|---------------|---------------|------------|-------|---------------|---------------|------------|-------|
| 10965R93 | 2-2707-BO-2 | IHC | 5 | 1100181 | 20-102-1 | Delco-Remy | 10 |
| 1100072 | 20-124-1 | Delco-Remy | 17 | 1100182 | 20-102-1 | Delco-Remy | 10 |
| 1100073 | 20-124-1 | Delco-Remy | 17 | 1100185 | 20-124-1 | Delco-Remy | 17 |
| 1100075 | 20-126-1 | Delco-Remy | 18 | 1100188 | 20-124-1 | Delco-Remy | 17 |
| 1100076 | 20-126-1 | Delco-Remy | 18 | 1100189 | 20-124-1 | Delco-Remy | 17 |
| 1100077 | 20-127-1 | Delco-Remy | 18 | 1100196 | 20-102-1 | Delco-Remy | 10 |
| 1100080 | 20-124-1 | Delco-Remy | 17 | 1100198 | 20-102-1 | Delco-Remy | 10 |
| 1100081 | 20-124-1 | Delco-Remy | 17 | 1100199 | 20-102-1 | Delco-Remy | 10 |
| 1100082 | 20-126-1 | Delco-Remy | 18 | 1100201 | 20-102-1 | Delco-Remy | 10 |
| 1100083 | 20-126-1 | Delco-Remy | 18 | 1100202 | 20-102-1 | Delco-Remy | 10 |
| 1100084 | 20-124-1 | Delco-Remy | 17 | 1100203 | 20-102-1 | Delco-Remy | 10 |
| 1100086 | 20-124-1 | Delco-Remy | 17 | 1100204 | 20-102-1 | Delco-Remy | 10 |
| 1100087 | 20-124-1 | Delco-Remy | 17 | 1100211 | 20-127-1 | Delco-Remy | 18 |
| 1100088 | 20-126-1 | Delco-Remy | 18 | 1100212 | 20-124-1 | Delco-Remy | 17 |
| 1100089 | 20-124-1 | Delco-Remy | 17 | 1100213 | 20-124-1 | Delco-Remy | 17 |
| 1100090 | 20-124-1 | Delco-Remy | 17 | 1100214 | 20-126-1 | Delco-Remy | 18 |
| 1100091 | 20-125-1 | Delco-Remy | 17 | 1100215 | 20-125-1 | Delco-Remy | 17 |
| 1100092 | 1-2410-11DR | Delco-Remy | 9 | 1100218 | 20-102-1 | Delco-Remy | 10 |
| 1100092 | 1-2410-11DR-1 | Delco-Remy | 9 | 1100221 | 20-102-5 | Delco-Remy | 10 |
| 1100093 | 20-127-1 | Delco-Remy | 18 | 1100222 | 20-102-5 | Delco-Remy | 10 |
| 1100110 | 20-102-1 | Delco-Remy | 10 | 1100225 | 20-102-1 | Delco-Remy | 10 |
| 1100111 | 20-102-1 | Delco-Remy | 10 | 1100226 | 20-102-1 | Delco-Remy | 10 |
| 1100113 | 20-102-1 | Delco-Remy | 10 | 1100227 | 20-102-1 | Delco-Remy | 10 |
| 1100115 | 20-102-1 | Delco-Remy | 10 | 1100228 | 20-102-1 | Delco-Remy | 10 |
| 1100116 | 20-102-1 | Delco-Remy | 10 | 1100229 | 20-102-1 | Delco-Remy | 10 |
| 1100117 | 20-102-1 | Delco-Remy | 10 | 1100230 | 20-102-1 | Delco-Remy | 10 |
| 1100121 | 20-102-1 | Delco-Remy | 10 | 1100231 | 20-102-1 | Delco-Remy | 10 |
| 1100122 | 20-102-1 | Delco-Remy | 10 | 1100232 | 20-102-1 | Delco-Remy | 10 |
| 1100124 | 20-102-1 | Delco-Remy | 10 | 1100233 | 20-102-1 | Delco-Remy | 10 |
| 1100125 | 20-102-1 | Delco-Remy | 10 | 1100235 | 20-102-1 | Delco-Remy | 10 |
| 1100127 | 20-102-1 | Delco-Remy | 10 | 1100236 | 20-102-1 | Delco-Remy | 10 |
| 1100128 | 20-102-1 | Delco-Remy | 10 | 1100238 | 20-102-1 | Delco-Remy | 10 |
| 1100129 | 20-102-1 | Delco-Remy | 10 | 1100256 | 20-102-1 | Delco-Remy | 10 |
| 1100130 | 20-102-1 | Delco-Remy | 10 | 1100266 | 20-102-1 | Delco-Remy | 10 |
| 1100131 | 20-102-5 | Delco-Remy | 10 | 1100267 | 20-102-1 | Delco-Remy | 10 |
| 1100132 | 20-102-5 | Delco-Remy | 10 | 1100268 | 20-102-1 | Delco-Remy | 10 |
| 1100133 | 20-102-1 | Delco-Remy | 10 | 1100274 | 20-127-1 | Delco-Remy | 18 |
| 1100135 | 20-102-1 | Delco-Remy | 10 | 1100280 | 20-102-5 | Delco-Remy | 10 |
| 1100136 | 20-102-1 | Delco-Remy | 10 | 1100281 | 20-102-5 | Delco-Remy | 10 |
| 1100137 | 20-102-1 | Delco-Remy | 10 | 1100294 | 20-102-5 | Delco-Remy | 10 |
| 1100140 | 20-102-1 | Delco-Remy | 10 | 1100297 | 20-102-1 | Delco-Remy | 10 |
| 1100141 | 20-102-1 | Delco-Remy | 10 | 1100477 | 20-102-1 | Delco-Remy | 10 |
| 1100142 | 20-102-1 | Delco-Remy | 10 | 1100485 | 20-102-1 | Delco-Remy | 10 |
| 1100143 | 20-102-1 | Delco-Remy | 10 | 1100487 | 20-102-1 | Delco-Remy | 10 |
| 1100144 | 20-102-1 | Delco-Remy | 10 | 1100490 | 20-104-1 | Delco-Remy | 10 |
| 1100145 | 20-102-1 | Delco-Remy | 10 | 1100491 | 20-104-1 | Delco-Remy | 10 |
| 1100146 | 20-102-1 | Delco-Remy | 10 | 1100492 | 20-102-1 | Delco-Remy | 10 |
| 1100147 | 20-102-1 | Delco-Remy | 10 | 1100493 | 20-104-1 | Delco-Remy | 10 |
| 1100148 | 20-102-1 | Delco-Remy | 10 | 1100494 | 20-102-1 | Delco-Remy | 10 |
| 1100149 | 20-102-1 | Delco-Remy | 10 | 1100495 | 20-102-1 | Delco-Remy | 10 |
| 1100150 | 20-102-1 | Delco-Remy | 10 | 1100496 | 20-102-1 | Delco-Remy | 10 |
| 1100151 | 20-102-1 | Delco-Remy | 10 | 1100497 | 20-102-1 | Delco-Remy | 10 |
| 1100152 | 20-102-1 | Delco-Remy | 10 | 1100498 | 20-102-1 | Delco-Remy | 10 |
| 1100153 | 20-102-1 | Delco-Remy | 10 | 1100499 | 1-2410-11DR | Delco-Remy | 9 |
| 1100155 | 20-102-1 | Delco-Remy | 10 | 1100499 | 1-2410-11DR-1 | Delco-Remy | 9 |
| 1100156 | 20-102-1 | Delco-Remy | 10 | 1100542 | 20-102-1 | Delco-Remy | 10 |
| 1100157 | 20-102-1 | Delco-Remy | 10 | 1100543 | 20-102-1 | Delco-Remy | 10 |
| 1100158 | 20-102-1 | Delco-Remy | 10 | 1100544 | 20-102-1 | Delco-Remy | 10 |
| 1100159 | 20-102-1 | Delco-Remy | 10 | 1100545 | 20-102-1 | Delco-Remy | 10 |
| 1100162 | 20-102-1 | Delco-Remy | 10 | 1100546 | 20-102-1 | Delco-Remy | 10 |
| 1100163 | 20-102-1 | Delco-Remy | 10 | 1100547 | 20-102-1 | Delco-Remy | 10 |
| 1100164 | 20-102-1 | Delco-Remy | 10 | 1100548 | 20-102-1 | Delco-Remy | 10 |
| 1100165 | 20-102-1 | Delco-Remy | 10 | 1100549 | 20-102-1 | Delco-Remy | 10 |
| 1100166 | 20-102-1 | Delco-Remy | 10 | 1100550 | 20-102-1 | Delco-Remy | 10 |
| 1100167 | 20-102-1 | Delco-Remy | 10 | 1100551 | 20-102-1 | Delco-Remy | 10 |
| 1100168 | 20-102-1 | Delco-Remy | 10 | 1100552 | 20-102-1 | Delco-Remy | 10 |
| 1100170 | 20-104-1 | Delco-Remy | 10 | 1100553 | 20-101-1 | Delco-Remy | 9 |
| 1100171 | 20-104-1 | Delco-Remy | 10 | 1100554 | 20-102-1 | Delco-Remy | 10 |
| 1100174 | 20-102-1 | Delco-Remy | 10 | 1100556 | 20-102-1 | Delco-Remy | 10 |
| 1100175 | 20-102-1 | Delco-Remy | 10 | 1100557 | 20-101-1 | Delco-Remy | 9 |
| 1100176 | 20-102-1 | Delco-Remy | 10 | 1100558 | 20-101-1 | Delco-Remy | 9 |
| 1100179 | 20-102-1 | Delco-Remy | 10 | 1100559 | 20-102-1 | Delco-Remy | 10 |

CROSS REFERENCE

CROSS REFERENCE - REF# to CATALOG#

| Mfr. Part# | Catalog# | Mfr. Name | Pg. # | Mfr. Part# | Catalog# | Mfr. Name | Pg. # |
|------------|----------|------------|-------|------------|----------|------------|-------|
| 1100560 | 20-102-1 | Delco-Remy | 10 | 1100854 | 20-102-1 | Delco-Remy | 10 |
| 1100561 | 20-102-1 | Delco-Remy | 10 | 1100855 | 20-102-1 | Delco-Remy | 10 |
| 1100562 | 20-102-1 | Delco-Remy | 10 | 1100856 | 20-101-1 | Delco-Remy | 9 |
| 1100563 | 20-102-1 | Delco-Remy | 10 | 1100859 | 20-102-1 | Delco-Remy | 10 |
| 1100564 | 20-102-1 | Delco-Remy | 10 | 1100860 | 20-101-1 | Delco-Remy | 9 |
| 1100565 | 20-102-1 | Delco-Remy | 10 | 1100861 | 20-102-1 | Delco-Remy | 10 |
| 1100566 | 20-101-1 | Delco-Remy | 9 | 1100865 | 20-102-1 | Delco-Remy | 10 |
| 1100567 | 20-101-1 | Delco-Remy | 9 | 1100870 | 20-101-1 | Delco-Remy | 9 |
| 1100568 | 20-101-1 | Delco-Remy | 9 | 1100871 | 20-101-1 | Delco-Remy | 9 |
| 1100569 | 20-101-1 | Delco-Remy | 9 | 1100872 | 20-102-1 | Delco-Remy | 10 |
| 1100570 | 20-101-1 | Delco-Remy | 9 | 1100873 | 20-102-1 | Delco-Remy | 10 |
| 1100571 | 20-101-1 | Delco-Remy | 9 | 1100874 | 20-102-1 | Delco-Remy | 10 |
| 1100572 | 20-101-1 | Delco-Remy | 9 | 1100875 | 20-101-1 | Delco-Remy | 9 |
| 1100573 | 20-102-1 | Delco-Remy | 10 | 1100878 | 20-101-1 | Delco-Remy | 9 |
| 1100574 | 20-102-1 | Delco-Remy | 10 | 1100879 | 20-101-1 | Delco-Remy | 9 |
| 1100575 | 20-102-1 | Delco-Remy | 10 | 1100880 | 20-102-1 | Delco-Remy | 10 |
| 1100578 | 20-104-1 | Delco-Remy | 10 | 1100881 | 20-102-1 | Delco-Remy | 10 |
| 1100579 | 20-104-1 | Delco-Remy | 10 | 1100882 | 20-102-1 | Delco-Remy | 10 |
| 1100580 | 20-104-1 | Delco-Remy | 10 | 1100883 | 20-101-1 | Delco-Remy | 9 |
| 1100581 | 20-104-1 | Delco-Remy | 10 | 1100884 | 20-102-1 | Delco-Remy | 10 |
| 1100582 | 20-104-1 | Delco-Remy | 10 | 1100885 | 20-101-1 | Delco-Remy | 9 |
| 1100583 | 20-104-1 | Delco-Remy | 10 | 1100886 | 20-101-1 | Delco-Remy | 9 |
| 1100584 | 20-104-1 | Delco-Remy | 10 | 1100888 | 20-101-1 | Delco-Remy | 9 |
| 1100585 | 20-104-1 | Delco-Remy | 10 | 1100889 | 20-101-1 | Delco-Remy | 9 |
| 1100587 | 20-104-1 | Delco-Remy | 10 | 1100890 | 20-102-1 | Delco-Remy | 10 |
| 1100588 | 20-102-1 | Delco-Remy | 10 | 1100891 | 20-101-1 | Delco-Remy | 9 |
| 1100589 | 20-104-1 | Delco-Remy | 10 | 1100892 | 20-101-1 | Delco-Remy | 9 |
| 1100590 | 20-101-1 | Delco-Remy | 9 | 1100893 | 20-101-1 | Delco-Remy | 9 |
| 1100591 | 20-101-1 | Delco-Remy | 9 | 1100895 | 20-101-1 | Delco-Remy | 9 |
| 1100592 | 20-102-1 | Delco-Remy | 10 | 1100896 | 20-101-1 | Delco-Remy | 9 |
| 1100593 | 20-104-1 | Delco-Remy | 10 | 1100897 | 20-102-1 | Delco-Remy | 10 |
| 1100595 | 20-102-1 | Delco-Remy | 10 | 1100899 | 20-102-1 | Delco-Remy | 10 |
| 1100596 | 20-102-1 | Delco-Remy | 10 | 1100900 | 20-102-1 | Delco-Remy | 10 |
| 1100597 | 20-102-1 | Delco-Remy | 10 | 1100901 | 20-102-1 | Delco-Remy | 10 |
| 1100598 | 20-102-1 | Delco-Remy | 10 | 1100902 | 20-102-1 | Delco-Remy | 10 |
| 1100662 | 20-101-1 | Delco-Remy | 9 | 1100903 | 20-102-1 | Delco-Remy | 10 |
| 1100742 | 20-101-1 | Delco-Remy | 9 | 1100904 | 20-102-1 | Delco-Remy | 10 |
| 1100750 | 20-101-1 | Delco-Remy | 9 | 1100905 | 20-101-1 | Delco-Remy | 9 |
| 1100778 | 20-101-1 | Delco-Remy | 9 | 1100906 | 20-101-1 | Delco-Remy | 9 |
| 1100780 | 20-101-1 | Delco-Remy | 9 | 1100907 | 20-101-1 | Delco-Remy | 9 |
| 1100787 | 20-101-1 | Delco-Remy | 9 | 1100908 | 20-101-1 | Delco-Remy | 9 |
| 1100790 | 20-101-1 | Delco-Remy | 9 | 1100910 | 20-101-1 | Delco-Remy | 9 |
| 1100791 | 20-101-1 | Delco-Remy | 9 | 1100911 | 20-102-1 | Delco-Remy | 10 |
| 1100793 | 20-101-1 | Delco-Remy | 9 | 1100916 | 20-101-1 | Delco-Remy | 9 |
| 1100796 | 20-101-1 | Delco-Remy | 9 | 1100917 | 20-101-1 | Delco-Remy | 9 |
| 1100797 | 20-101-1 | Delco-Remy | 9 | 1100919 | 20-102-1 | Delco-Remy | 10 |
| 1100804 | 20-101-1 | Delco-Remy | 9 | 1100920 | 20-102-1 | Delco-Remy | 10 |
| 1100810 | 20-101-1 | Delco-Remy | 9 | 1100921 | 20-101-1 | Delco-Remy | 9 |
| 1100816 | 20-101-1 | Delco-Remy | 9 | 1100922 | 20-102-1 | Delco-Remy | 10 |
| 1100817 | 20-101-1 | Delco-Remy | 9 | 1100923 | 20-102-1 | Delco-Remy | 10 |
| 1100818 | 20-101-1 | Delco-Remy | 9 | 1100924 | 20-102-1 | Delco-Remy | 10 |
| 1100825 | 20-102-1 | Delco-Remy | 10 | 1100925 | 20-102-1 | Delco-Remy | 10 |
| 1100826 | 20-102-1 | Delco-Remy | 10 | 1100926 | 20-102-1 | Delco-Remy | 10 |
| 1100830 | 20-102-1 | Delco-Remy | 10 | 1100927 | 20-102-1 | Delco-Remy | 10 |
| 1100831 | 20-102-1 | Delco-Remy | 10 | 1100928 | 20-102-1 | Delco-Remy | 10 |
| 1100832 | 20-102-1 | Delco-Remy | 10 | 1100929 | 20-102-1 | Delco-Remy | 10 |
| 1100833 | 20-102-1 | Delco-Remy | 10 | 1100930 | 20-102-1 | Delco-Remy | 10 |
| 1100834 | 20-101-1 | Delco-Remy | 9 | 1100931 | 20-101-1 | Delco-Remy | 9 |
| 1100836 | 20-101-1 | Delco-Remy | 9 | 1100932 | 20-101-1 | Delco-Remy | 9 |
| 1100837 | 20-101-1 | Delco-Remy | 9 | 1100933 | 20-101-1 | Delco-Remy | 9 |
| 1100838 | 20-101-1 | Delco-Remy | 9 | 1100934 | 20-102-1 | Delco-Remy | 10 |
| 1100839 | 20-101-1 | Delco-Remy | 9 | 1100935 | 20-102-1 | Delco-Remy | 10 |
| 1100841 | 20-101-1 | Delco-Remy | 9 | 1100936 | 20-104-1 | Delco-Remy | 10 |
| 1100842 | 20-101-1 | Delco-Remy | 9 | 1100937 | 20-102-1 | Delco-Remy | 10 |
| 1100843 | 20-101-1 | Delco-Remy | 9 | 1100939 | 20-101-1 | Delco-Remy | 9 |
| 1100845 | 20-101-1 | Delco-Remy | 9 | 1100940 | 20-102-1 | Delco-Remy | 10 |
| 1100846 | 20-101-1 | Delco-Remy | 9 | 1100943 | 20-101-1 | Delco-Remy | 9 |
| 1100847 | 20-101-1 | Delco-Remy | 9 | 1100944 | 20-101-1 | Delco-Remy | 9 |
| 1100849 | 20-101-1 | Delco-Remy | 9 | 1100945 | 20-101-1 | Delco-Remy | 9 |
| 1100851 | 20-101-1 | Delco-Remy | 9 | 1100946 | 20-102-1 | Delco-Remy | 10 |
| 1100852 | 20-102-1 | Delco-Remy | 10 | 1100947 | 20-102-1 | Delco-Remy | 10 |
| 1100853 | 20-102-1 | Delco-Remy | 10 | 1100948 | 20-102-1 | Delco-Remy | 10 |

CROSS REFERENCE

CROSS REFERENCE - REF# to CATALOG#

| Mfr. Part No. | Catalog No. | Mfr. Name | Pg. # | Mfr. Part No. | Catalog No. | Mfr. Name | Pg. # |
|---------------|-------------|------------|-------|---------------|-------------|------------|-------|
| 1100949 | 20-102-1 | Delco-Remy | 10 | 1102355 | 20-102-1 | Delco-Remy | 10 |
| 1100950 | 20-102-1 | Delco-Remy | 10 | 1102356 | 20-102-1 | Delco-Remy | 10 |
| 1100951 | 20-101-1 | Delco-Remy | 9 | 1102358 | 20-102-1 | Delco-Remy | 10 |
| 1101104 | 20-124-1 | Delco-Remy | 17 | 1102359 | 20-104-1 | Delco-Remy | 10 |
| 1101105 | 20-124-1 | Delco-Remy | 17 | 1102361 | 20-104-1 | Delco-Remy | 10 |
| 1101125 | 20-152-22-1 | Delco-Remy | 23 | 1102362 | 20-104-1 | Delco-Remy | 10 |
| 1101126 | 20-152-22-1 | Delco-Remy | 23 | 1102363 | 20-104-1 | Delco-Remy | 10 |
| 1101148 | 20-142-11-1 | Delco-Remy | 22 | 1102367 | 20-102-1 | Delco-Remy | 10 |
| 1101149 | 20-142-11-1 | Delco-Remy | 22 | 1102368 | 20-102-1 | Delco-Remy | 10 |
| 1101150 | 20-152-22-1 | Delco-Remy | 23 | 1102369 | 20-102-1 | Delco-Remy | 10 |
| 1101151 | 20-152-22-1 | Delco-Remy | 23 | 1102375 | 20-104-1 | Delco-Remy | 10 |
| 1101155 | 20-102-1 | Delco-Remy | 10 | 1102376 | 20-102-1 | Delco-Remy | 10 |
| 1101159 | 20-102-1 | Delco-Remy | 10 | 1102380 | 20-102-1 | Delco-Remy | 10 |
| 1101166 | 20-102-1 | Delco-Remy | 10 | 1102381 | 20-102-1 | Delco-Remy | 10 |
| 1101184 | 20-152-22-1 | Delco-Remy | 23 | 1102382 | 20-102-1 | Delco-Remy | 10 |
| 1101194 | 20-113-1 | Delco-Remy | 10 | 1102383 | 20-102-1 | Delco-Remy | 10 |
| 1101196 | 20-102-1 | Delco-Remy | 10 | 1102384 | 20-102-1 | Delco-Remy | 10 |
| 1101205 | 20-113-1 | Delco-Remy | 10 | 1102385 | 20-102-1 | Delco-Remy | 10 |
| 1101215 | 20-116-1 | Delco-Remy | 10 | 1102386 | 20-102-1 | Delco-Remy | 10 |
| 1101240 | 20-110-2 | Delco-Remy | 10 | 1102387 | 20-102-1 | Delco-Remy | 10 |
| 1101241 | 20-110-2 | Delco-Remy | 10 | 1102388 | 20-102-1 | Delco-Remy | 10 |
| 1101245 | 20-110-2 | Delco-Remy | 10 | 1102389 | 20-102-1 | Delco-Remy | 10 |
| 1101259 | 20-142-11-1 | Delco-Remy | 22 | 1102390 | 20-102-1 | Delco-Remy | 10 |
| 1101287 | 20-125-1 | Delco-Remy | 17 | 1102391 | 20-102-1 | Delco-Remy | 10 |
| 1101288 | 20-124-1 | Delco-Remy | 17 | 1102392 | 20-102-1 | Delco-Remy | 10 |
| 1101289 | 20-124-1 | Delco-Remy | 17 | 1102394 | 20-102-1 | Delco-Remy | 10 |
| 1101293 | 20-145-21-1 | Delco-Remy | 23 | 1102395 | 20-102-1 | Delco-Remy | 10 |
| 1101299 | 20-110-2 | Delco-Remy | 10 | 1102397 | 20-102-1 | Delco-Remy | 10 |
| 1101301 | 20-110-2 | Delco-Remy | 10 | 1102399 | 20-102-1 | Delco-Remy | 10 |
| 1101317 | 20-145-21-1 | Delco-Remy | 23 | 1102400 | 20-102-1 | Delco-Remy | 10 |
| 1101318 | 20-145-21-1 | Delco-Remy | 23 | 1102457 | 20-102-1 | Delco-Remy | 10 |
| 1101346 | 20-142-32-1 | Delco-Remy | 22 | 1102460 | 20-102-1 | Delco-Remy | 10 |
| 1101439 | 20-113-1 | Delco-Remy | 10 | 1102461 | 20-102-1 | Delco-Remy | 10 |
| 1101440 | 20-113-1 | Delco-Remy | 10 | 1102465 | 20-102-1 | Delco-Remy | 10 |
| 1101464 | 20-152-22-1 | Delco-Remy | 23 | 1102466 | 20-102-1 | Delco-Remy | 10 |
| 1101465 | 20-152-31-1 | Delco-Remy | 24 | 1102467 | 20-102-1 | Delco-Remy | 10 |
| 1101478 | 20-189-11-1 | Delco-Remy | 24 | 1102468 | 20-102-1 | Delco-Remy | 10 |
| 1101480 | 20-189-11-1 | Delco-Remy | 24 | 1102469 | 20-102-1 | Delco-Remy | 10 |
| 1101484 | 20-110-2 | Delco-Remy | 10 | 1102471 | 20-102-1 | Delco-Remy | 10 |
| 1101491 | 20-175-11 | Delco-Remy | 27 | 1102472 | 20-102-1 | Delco-Remy | 10 |
| 1101493 | 20-175-11 | Delco-Remy | 27 | 1102473 | 20-102-1 | Delco-Remy | 10 |
| 1101500 | 20-145-11-1 | Delco-Remy | 23 | 1102474 | 20-102-1 | Delco-Remy | 10 |
| 1101521 | 20-145-11-1 | Delco-Remy | 23 | 1102475 | 20-102-1 | Delco-Remy | 10 |
| 1101571 | 20-184-32 | Delco-Remy | 24 | 1102476 | 20-102-1 | Delco-Remy | 10 |
| 1101582 | 20-145-31-1 | Delco-Remy | 23 | 1102477 | 20-102-1 | Delco-Remy | 10 |
| 110-159 | 20-412 | Prestolite | 75 | 1102478 | 20-102-1 | Delco-Remy | 10 |
| 1101616 | 20-145-11-1 | Delco-Remy | 23 | 1102479 | 20-102-1 | Delco-Remy | 10 |
| 1101617 | 20-145-11-1 | Delco-Remy | 23 | 1102480 | 20-102-1 | Delco-Remy | 10 |
| 1101618 | 20-142-32-1 | Delco-Remy | 22 | 1102481 | 20-102-1 | Delco-Remy | 10 |
| 1101619 | 20-152-11-1 | Delco-Remy | 23 | 1102482 | 20-102-1 | Delco-Remy | 10 |
| 1101620 | 20-145-21-1 | Delco-Remy | 23 | 1102483 | 20-102-1 | Delco-Remy | 10 |
| 1101621 | 20-152-11-1 | Delco-Remy | 23 | 1102484 | 20-102-1 | Delco-Remy | 10 |
| 1101628 | 20-145-21-1 | Delco-Remy | 23 | 1102485 | 20-102-1 | Delco-Remy | 10 |
| 1101629 | 20-145-21-1 | Delco-Remy | 23 | 1102486 | 20-102-1 | Delco-Remy | 10 |
| 1101630 | 20-152-11-1 | Delco-Remy | 23 | 1102487 | 20-102-1 | Delco-Remy | 10 |
| 1101634 | 20-152-31-1 | Delco-Remy | 24 | 1102488 | 20-102-1 | Delco-Remy | 10 |
| 1101637 | 20-145-11-1 | Delco-Remy | 23 | 1102489 | 20-102-1 | Delco-Remy | 10 |
| 1101806 | 20-184-32 | Delco-Remy | 24 | 1102490 | 20-102-1 | Delco-Remy | 10 |
| 1101807 | 20-152-31-1 | Delco-Remy | 24 | 1102491 | 20-102-1 | Delco-Remy | 10 |
| 1101812 | 20-152-11-1 | Delco-Remy | 23 | 1102492 | 20-102-1 | Delco-Remy | 10 |
| 1101814 | 20-152-32-1 | Delco-Remy | 24 | 1102493 | 20-102-1 | Delco-Remy | 10 |
| 1101815 | 20-152-31-1 | Delco-Remy | 24 | 1102494 | 20-102-1 | Delco-Remy | 10 |
| 110-225 | 20-412 | Prestolite | 75 | 1102495 | 20-102-1 | Delco-Remy | 10 |
| 1102311 | 20-102-1 | Delco-Remy | 10 | 1102497 | 20-102-1 | Delco-Remy | 10 |
| 1102346 | 20-102-1 | Delco-Remy | 10 | 1102499 | 20-102-1 | Delco-Remy | 10 |
| 1102347 | 20-102-1 | Delco-Remy | 10 | 1102500 | 20-102-1 | Delco-Remy | 10 |
| 1102349 | 20-102-1 | Delco-Remy | 10 | 1102548 | 20-102-1 | Delco-Remy | 10 |
| 1102350 | 20-102-1 | Delco-Remy | 10 | 1102549 | 20-102-1 | Delco-Remy | 10 |
| 1102351 | 20-102-1 | Delco-Remy | 10 | 1102550 | 20-102-1 | Delco-Remy | 10 |
| 1102352 | 20-102-1 | Delco-Remy | 10 | 1102551 | 20-113-1 | Delco-Remy | 10 |
| 1102353 | 20-102-1 | Delco-Remy | 10 | 1102593 | 20-102-1 | Delco-Remy | 10 |
| 1102354 | 20-102-1 | Delco-Remy | 10 | 1102605 | 20-1105-41 | Delco-Remy | 28 |

CROSS REFERENCE

CROSS REFERENCE - REF# to CATALOG#

| Mfr. Part No. | Catalog No. | Mfr. Name | Pg. # | Mfr. Part No. | Catalog No. | Mfr. Name | Pg. # |
|---------------|---------------|------------|-------|---------------|---------------|------------|-------|
| 1103092 | 20-102-1 | Delco-Remy | 10 | 1103175 | 20-104-1 | Delco-Remy | 10 |
| 1103093 | 20-102-1 | Delco-Remy | 10 | 1103182 | 20-102-1 | Delco-Remy | 10 |
| 1103094 | 20-102-1 | Delco-Remy | 10 | 1103183 | 20-104-1 | Delco-Remy | 10 |
| 1103095 | 20-102-1 | Delco-Remy | 10 | 1103184 | 20-104-1 | Delco-Remy | 10 |
| 1103096 | 20-102-1 | Delco-Remy | 10 | 1103186 | 20-102-1 | Delco-Remy | 10 |
| 1103097 | 20-102-1 | Delco-Remy | 10 | 1103187 | 20-102-1 | Delco-Remy | 10 |
| 1103098 | 20-102-1 | Delco-Remy | 10 | 1103190 | 1-2410-11DR | Delco-Remy | 9 |
| 1103099 | 20-102-1 | Delco-Remy | 10 | 1103190 | 1-2410-11DR-1 | Delco-Remy | 9 |
| 1103100 | 20-102-1 | Delco-Remy | 10 | 1103195 | 20-102-1 | Delco-Remy | 10 |
| 1103101 | 20-102-1 | Delco-Remy | 10 | 1103197 | 20-102-1 | Delco-Remy | 10 |
| 1103102 | 20-102-1 | Delco-Remy | 10 | 1103198 | 20-102-1 | Delco-Remy | 10 |
| 1103103 | 20-102-1 | Delco-Remy | 10 | 1103199 | 20-102-1 | Delco-Remy | 10 |
| 1103104 | 20-102-1 | Delco-Remy | 10 | 11047 | 1-2602-01VA | Lester | 112 |
| 1103105 | 20-102-1 | Delco-Remy | 10 | 1105033 | 20-102-1 | Delco-Remy | 10 |
| 1103106 | 20-102-1 | Delco-Remy | 10 | 1105043 | 20-102-1 | Delco-Remy | 10 |
| 1103108 | 20-102-1 | Delco-Remy | 10 | 1105050 | 20-102-1 | Delco-Remy | 10 |
| 1103109 | 20-102-1 | Delco-Remy | 10 | 1105063 | 1-2410-11DR | Delco-Remy | 9 |
| 1103110 | 20-102-1 | Delco-Remy | 10 | 1105063 | 1-2410-11DR-1 | Delco-Remy | 9 |
| 1103111 | 20-102-1 | Delco-Remy | 10 | 1105066 | 20-104-1 | Delco-Remy | 10 |
| 1103112 | 20-102-1 | Delco-Remy | 10 | 1105067 | 20-102-1 | Delco-Remy | 10 |
| 1103116 | 20-104-1 | Delco-Remy | 10 | 1105068 | 20-104-1 | Delco-Remy | 10 |
| 1103117 | 20-102-1 | Delco-Remy | 10 | 1105069 | 20-104-1 | Delco-Remy | 10 |
| 1103118 | 20-102-1 | Delco-Remy | 10 | 1105070 | 20-104-1 | Delco-Remy | 10 |
| 1103119 | 20-102-1 | Delco-Remy | 10 | 1105072 | 20-104-1 | Delco-Remy | 10 |
| 1103120 | 20-102-1 | Delco-Remy | 10 | 1105073 | 20-104-1 | Delco-Remy | 10 |
| 1103121 | 20-102-1 | Delco-Remy | 10 | 1105076 | 1-2410-11DR | Delco-Remy | 9 |
| 1103122 | 20-102-1 | Delco-Remy | 10 | 1105076 | 1-2410-11DR-1 | Delco-Remy | 9 |
| 1103124 | 20-104-1 | Delco-Remy | 10 | 1105079 | 20-102-1 | Delco-Remy | 10 |
| 1103125 | 20-104-1 | Delco-Remy | 10 | 1105080 | 20-102-1 | Delco-Remy | 10 |
| 1103126 | 20-104-1 | Delco-Remy | 10 | 1105160 | 20-104-1 | Delco-Remy | 10 |
| 1103127 | 20-104-1 | Delco-Remy | 10 | 1105162 | 20-104-1 | Delco-Remy | 10 |
| 1103128 | 20-104-1 | Delco-Remy | 10 | 1105164 | 20-104-1 | Delco-Remy | 10 |
| 1103130 | 20-104-1 | Delco-Remy | 10 | 1105165 | 20-104-1 | Delco-Remy | 10 |
| 1103131 | 20-104-1 | Delco-Remy | 10 | 1105166 | 20-104-1 | Delco-Remy | 10 |
| 1103133 | 20-104-1 | Delco-Remy | 10 | 1105167 | 20-104-1 | Delco-Remy | 10 |
| 1103134 | 1-2410-11DR | Delco-Remy | 9 | 1105168 | 20-104-1 | Delco-Remy | 10 |
| 1103134 | 1-2410-11DR-1 | Delco-Remy | 9 | 1105169 | 20-104-1 | Delco-Remy | 10 |
| 1103135 | 20-104-1 | Delco-Remy | 10 | 1105170 | 20-104-1 | Delco-Remy | 10 |
| 1103138 | 20-104-1 | Delco-Remy | 10 | 1105171 | 20-104-1 | Delco-Remy | 10 |
| 1103139 | 20-102-1 | Delco-Remy | 10 | 1105172 | 20-104-1 | Delco-Remy | 10 |
| 1103140 | 20-102-1 | Delco-Remy | 10 | 1105173 | 20-104-1 | Delco-Remy | 10 |
| 1103141 | 20-104-1 | Delco-Remy | 10 | 1105174 | 20-104-1 | Delco-Remy | 10 |
| 1103142 | 20-102-1 | Delco-Remy | 10 | 1105175 | 20-104-1 | Delco-Remy | 10 |
| 1103143 | 20-102-1 | Delco-Remy | 10 | 1105176 | 20-104-1 | Delco-Remy | 10 |
| 1103144 | 20-102-1 | Delco-Remy | 10 | 1105177 | 20-104-1 | Delco-Remy | 10 |
| 1103145 | 20-102-1 | Delco-Remy | 10 | 1105178 | 20-104-1 | Delco-Remy | 10 |
| 1103146 | 20-102-1 | Delco-Remy | 10 | 1105181 | 20-102-1 | Delco-Remy | 10 |
| 1103147 | 20-102-1 | Delco-Remy | 10 | 1105185 | 20-102-1 | Delco-Remy | 10 |
| 1103148 | 20-102-1 | Delco-Remy | 10 | 1105188 | 20-104-1 | Delco-Remy | 10 |
| 1103149 | 20-102-1 | Delco-Remy | 10 | 1105244 | 20-102-1 | Delco-Remy | 10 |
| 1103151 | 20-102-1 | Delco-Remy | 10 | 1105348 | 20-102-1 | Delco-Remy | 10 |
| 1103152 | 20-102-1 | Delco-Remy | 10 | 1105351 | 20-102-1 | Delco-Remy | 10 |
| 1103153 | 20-102-1 | Delco-Remy | 10 | 1105360 | 20-102-1 | Delco-Remy | 10 |
| 1103154 | 20-102-1 | Delco-Remy | 10 | 1105365 | 20-102-1 | Delco-Remy | 10 |
| 1103155 | 20-102-1 | Delco-Remy | 10 | 1105368 | 1-2614-01VA | Scania | 112 |
| 1103156 | 20-102-1 | Delco-Remy | 10 | 1105418 | 20-113-1 | Delco-Remy | 10 |
| 1103157 | 20-102-1 | Delco-Remy | 10 | 1105420 | 20-104-1 | Delco-Remy | 10 |
| 1103158 | 20-102-1 | Delco-Remy | 10 | 1105421 | 20-104-1 | Delco-Remy | 10 |
| 1103159 | 20-104-1 | Delco-Remy | 10 | 1105422 | 20-104-1 | Delco-Remy | 10 |
| 1103160 | 20-104-1 | Delco-Remy | 10 | 1105423 | 20-104-1 | Delco-Remy | 10 |
| 1103161 | 20-102-1 | Delco-Remy | 10 | 1105425 | 20-110-2 | Delco-Remy | 10 |
| 1103162 | 20-102-1 | Delco-Remy | 10 | 1105429 | 20-104-1 | Delco-Remy | 10 |
| 1103163 | 20-102-1 | Delco-Remy | 10 | 1105441 | 20-110-2 | Delco-Remy | 10 |
| 1103165 | 20-104-1 | Delco-Remy | 10 | 1105442 | 20-110-2 | Delco-Remy | 10 |
| 1103166 | 20-104-1 | Delco-Remy | 10 | 1105443 | 20-110-2 | Delco-Remy | 10 |
| 1103168 | 20-102-1 | Delco-Remy | 10 | 1105444 | 20-110-2 | Delco-Remy | 10 |
| 1103169 | 20-102-1 | Delco-Remy | 10 | 1105446 | 20-110-2 | Delco-Remy | 10 |
| 1103170 | 20-102-1 | Delco-Remy | 10 | 1105447 | 20-110-2 | Delco-Remy | 10 |
| 1103171 | 20-104-1 | Delco-Remy | 10 | 1105449 | 20-110-2 | Delco-Remy | 10 |
| 1103172 | 20-104-1 | Delco-Remy | 10 | 1105457 | 20-104-1 | Delco-Remy | 10 |
| 1103173 | 20-104-1 | Delco-Remy | 10 | 1105460 | 20-124-1 | Delco-Remy | 17 |
| 1103174 | 20-104-1 | Delco-Remy | 10 | 1105461 | 20-126-1 | Delco-Remy | 18 |

CROSS REFERENCE

CROSS REFERENCE - REF# to CATALOG#

| Mfr. Part# | Catalog# | Mfr. Name | Pg. # | Mfr. Part# | Catalog# | Mfr. Name | Pg. # |
|------------|-------------|------------|-------|------------|-------------|------------|-------|
| 1105462 | 20-124-1 | Delco-Remy | 17 | 1105688 | 20-152-11-1 | Delco-Remy | 23 |
| 1105463 | 20-124-1 | Delco-Remy | 17 | 1105690 | 20-116-1 | Delco-Remy | 10 |
| 1105464 | 20-124-1 | Delco-Remy | 17 | 1105691 | 20-102-1 | Delco-Remy | 10 |
| 1105465 | 20-124-1 | Delco-Remy | 17 | 1105703 | 20-102-1 | Delco-Remy | 10 |
| 1105466 | 20-126-1 | Delco-Remy | 18 | 1105704 | 20-102-1 | Delco-Remy | 10 |
| 1105467 | 20-124-1 | Delco-Remy | 17 | 1105705 | 20-102-1 | Delco-Remy | 10 |
| 1105468 | 20-126-1 | Delco-Remy | 18 | 1105710 | 20-145-31-1 | Delco-Remy | 23 |
| 1105469 | 20-124-1 | Delco-Remy | 17 | 1105712 | 20-152-11-1 | Delco-Remy | 23 |
| 1105470 | 20-124-1 | Delco-Remy | 17 | 1105716 | 20-152-11-1 | Delco-Remy | 23 |
| 1105471 | 20-126-1 | Delco-Remy | 18 | 1105718 | 20-152-31-1 | Delco-Remy | 24 |
| 1105472 | 20-125-1 | Delco-Remy | 17 | 1105720 | 20-152-31-1 | Delco-Remy | 24 |
| 1105473 | 20-125-1 | Delco-Remy | 17 | 1105722 | 20-142-32-1 | Delco-Remy | 22 |
| 1105474 | 20-127-1 | Delco-Remy | 18 | 1105725 | 20-142-11-1 | Delco-Remy | 22 |
| 1105475 | 20-127-1 | Delco-Remy | 18 | 1107067 | 2-2287-DR | Delco-Remy | 44 |
| 1105476 | 20-127-1 | Delco-Remy | 18 | 1107093 | 2-2287-DR | Delco-Remy | 44 |
| 1105478 | 20-102-1 | Delco-Remy | 10 | 1107233 | 2-1601-DR-2 | Delco-Remy | 48 |
| 1105492 | 20-110-2 | Delco-Remy | 10 | 1107273 | 2-1601-DR-2 | Delco-Remy | 48 |
| 1105495 | 20-110-2 | Delco-Remy | 10 | 1107274 | 2-1601-DR-2 | Delco-Remy | 48 |
| 1105496 | 20-110-2 | Delco-Remy | 10 | 1107315 | 2-1601-DR-2 | Delco-Remy | 48 |
| 1105499 | 20-116-1 | Delco-Remy | 10 | 1107365 | 2-1595-DR | Delco-Remy | 48 |
| 1105506 | 20-110-2 | Delco-Remy | 10 | 1107369 | 2-1601-DR-2 | Delco-Remy | 48 |
| 1105507 | 20-110-2 | Delco-Remy | 10 | 1107378 | 2-2596-DR-2 | Delco-Remy | 49 |
| 1105514 | 20-104-1 | Delco-Remy | 10 | 1107427 | 2-2286-DR | Delco-Remy | 43 |
| 1105520 | 20-102-1 | Delco-Remy | 10 | 1107448 | 2-2286-DR | Delco-Remy | 43 |
| 1105522 | 20-102-1 | Delco-Remy | 10 | 1107497 | 2-1601-DR-2 | Delco-Remy | 48 |
| 1105535 | 20-113-1 | Delco-Remy | 10 | 1107664 | 2-1601-DR-2 | Delco-Remy | 48 |
| 1105536 | 20-113-1 | Delco-Remy | 10 | 1107688 | 2-1601-DR-2 | Delco-Remy | 48 |
| 1105538 | 20-113-1 | Delco-Remy | 10 | 1107889 | 2-1601-DR-2 | Delco-Remy | 48 |
| 1105539 | 20-113-1 | Delco-Remy | 10 | 1107891 | 2-1601-DR-2 | Delco-Remy | 48 |
| 1105540 | 20-113-1 | Delco-Remy | 10 | 1108332 | 2-1601-DR-2 | Delco-Remy | 48 |
| 1105541 | 20-110-2 | Delco-Remy | 10 | 1108338 | 2-1595-DR | Delco-Remy | 48 |
| 1105542 | 20-110-2 | Delco-Remy | 10 | 1108350 | 2-1595-DR | Delco-Remy | 48 |
| 1105543 | 20-110-2 | Delco-Remy | 10 | 1108355 | 2-1601-DR-2 | Delco-Remy | 48 |
| 1105544 | 20-110-2 | Delco-Remy | 10 | 1108360 | 2-1601-DR-2 | Delco-Remy | 48 |
| 1105545 | 20-110-2 | Delco-Remy | 10 | 1108368 | 2-1601-DR-2 | Delco-Remy | 48 |
| 1105547 | 20-110-2 | Delco-Remy | 10 | 1108372 | 2-1601-DR-2 | Delco-Remy | 48 |
| 110-555 | 1-2429-00MO | Prestolite | 75 | 1108382 | 2-1595-DR | Delco-Remy | 48 |
| 1105556 | 20-102-1 | Delco-Remy | 10 | 1108400 | 2-1595-DR | Delco-Remy | 48 |
| 1105558 | 20-104-1 | Delco-Remy | 10 | 1108418 | 2-1595-DR | Delco-Remy | 48 |
| 1105559 | 20-104-1 | Delco-Remy | 10 | 1108429 | 2-1593-DR | Delco-Remy | 48 |
| 110-555HD | 1-2429-00MO | Prestolite | 75 | 1108430 | 2-1593-DR | Delco-Remy | 48 |
| 110-555JHO | 1-2564-00LN | Prestolite | 75 | 1108443 | 2-2753-DR-2 | Delco-Remy | 49 |
| 110-555P | 1-2532-00MO | Prestolite | 75 | 1108448 | 2-1604-DR | Delco-Remy | 48 |
| 110-555PHO | 1-2665-00LN | Prestolite | 76 | 1108486 | 2-1601-DR-2 | Delco-Remy | 48 |
| 1105560 | 20-113-1 | Delco-Remy | 10 | 1108489 | 2-1601-DR-2 | Delco-Remy | 48 |
| 1105573 | 20-104-1 | Delco-Remy | 10 | 1108493 | 2-2753-DR-2 | Delco-Remy | 49 |
| 1105574 | 20-104-1 | Delco-Remy | 10 | 1108502 | 2-1593-DR | Delco-Remy | 48 |
| 1105579 | 20-113-1 | Delco-Remy | 10 | 1108520 | 2-1595-DR | Delco-Remy | 48 |
| 1105581 | 20-110-2 | Delco-Remy | 10 | 1108748 | 2-1593-DR | Delco-Remy | 48 |
| 1105582 | 20-110-2 | Delco-Remy | 10 | 1108753 | 2-1598-DR-2 | Delco-Remy | 48 |
| 1105584 | 20-104-1 | Delco-Remy | 10 | 1108775 | 2-1595-DR | Delco-Remy | 48 |
| 1105592 | 20-110-2 | Delco-Remy | 10 | 1108776 | 2-1593-DR | Delco-Remy | 48 |
| 1105602 | 20-110-2 | Delco-Remy | 10 | 1108781 | 2-1593-DR | Delco-Remy | 48 |
| 1105604 | 20-110-2 | Delco-Remy | 10 | 1108782 | 2-1593-DR | Delco-Remy | 48 |
| 1105605 | 20-113-1 | Delco-Remy | 10 | 1108783 | 2-1595-DR | Delco-Remy | 48 |
| 1105606 | 20-110-2 | Delco-Remy | 10 | 1108784 | 2-1601-DR-2 | Delco-Remy | 48 |
| 1105607 | 20-102-1 | Delco-Remy | 10 | 1108787 | 2-1601-DR-2 | Delco-Remy | 48 |
| 1105608 | 20-102-1 | Delco-Remy | 10 | 1108788 | 2-1595-DR | Delco-Remy | 48 |
| 1105609 | 20-113-1 | Delco-Remy | 10 | 1108793 | 2-1601-DR-2 | Delco-Remy | 48 |
| 1105619 | 20-104-1 | Delco-Remy | 10 | 1108796 | 2-1593-DR | Delco-Remy | 48 |
| 1105629 | 20-110-2 | Delco-Remy | 10 | 1108830 | 50-108-1 | Delco-Remy | 41 |
| 1105630 | 20-110-2 | Delco-Remy | 10 | 1108830 | 50-108-2 | Delco-Remy | 41 |
| 1105648 | 20-110-2 | Delco-Remy | 10 | 1109025 | 2-1593-DR | Delco-Remy | 48 |
| 1105649 | 20-102-1 | Delco-Remy | 10 | 1109034 | 2-1598-DR-2 | Delco-Remy | 48 |
| 1105651 | 20-110-2 | Delco-Remy | 10 | 1109052 | 2-1593-DR | Delco-Remy | 48 |
| 1105654 | 20-110-2 | Delco-Remy | 10 | 1109057 | 2-1593-DR | Delco-Remy | 48 |
| 1105658 | 20-116-1 | Delco-Remy | 10 | 1109059 | 2-1595-DR | Delco-Remy | 48 |
| 1105661 | 20-152-32-1 | Delco-Remy | 24 | 1109065 | 2-1593-DR | Delco-Remy | 48 |
| 1105671 | 20-152-22-1 | Delco-Remy | 23 | 1109066 | 2-1593-DR | Delco-Remy | 48 |
| 1105672 | 20-152-22-1 | Delco-Remy | 23 | 1109068 | 2-1593-DR | Delco-Remy | 48 |
| 1105677 | 20-102-1 | Delco-Remy | 10 | 1109075 | 2-1598-DR-2 | Delco-Remy | 48 |
| 1105686 | 20-104-1 | Delco-Remy | 10 | 1109078 | 2-1601-DR-2 | Delco-Remy | 48 |

CROSS REFERENCE

CROSS REFERENCE - REF# to CATALOG#

| Mfr. Part No. | Catalog No. | Mfr. Name | Pg. # | Mfr. Part No. | Catalog No. | Mfr. Name | Pg. # |
|---------------|-------------|------------|-------|---------------|-------------|------------|-------|
| 1109091 | 2-2596-DR-2 | Delco-Remy | 49 | 1109775 | 50-111-1 | Delco-Remy | 43 |
| 1109099 | 2-1601-DR-2 | Delco-Remy | 48 | 1109776 | 50-111 | Delco-Remy | 43 |
| 1109192 | 50-8429 | Delco-Remy | 32 | 1109776 | 50-111-1 | Delco-Remy | 43 |
| 1109194 | 50-8429 | Delco-Remy | 32 | 1109777 | 50-111 | Delco-Remy | 43 |
| 1109222 | 50-111 | Delco-Remy | 43 | 1109777 | 50-111-1 | Delco-Remy | 43 |
| 1109222 | 50-111-1 | Delco-Remy | 43 | 1109778 | 50-111 | Delco-Remy | 43 |
| 1109285 | 50-111 | Delco-Remy | 43 | 1109778 | 50-111 | Delco-Remy | 43 |
| 1109285 | 50-111-1 | Delco-Remy | 43 | 1109778 | 50-111-1 | Delco-Remy | 43 |
| 1109286 | 50-111 | Delco-Remy | 43 | 1109780 | 50-111 | Delco-Remy | 43 |
| 1109286 | 50-111-1 | Delco-Remy | 43 | 1109780 | 50-111-1 | Delco-Remy | 43 |
| 1109286 | 50-111-1 | Delco-Remy | 43 | 1109782 | 50-111 | Delco-Remy | 43 |
| 1109287 | 50-111 | Delco-Remy | 43 | 1109782 | 50-111-1 | Delco-Remy | 43 |
| 1109287 | 50-111-1 | Delco-Remy | 43 | 1109787 | 50-111 | Delco-Remy | 43 |
| 1109288 | 50-111 | Delco-Remy | 43 | 1109787 | 50-111-1 | Delco-Remy | 43 |
| 1109288 | 50-111-1 | Delco-Remy | 43 | 1109787 | 50-111-1 | Delco-Remy | 43 |
| 1109289 | 50-111 | Delco-Remy | 43 | 1109790 | 2-2473-DR | Delco-Remy | 43 |
| 1109289 | 50-111-1 | Delco-Remy | 43 | 1109791 | 50-111 | Delco-Remy | 43 |
| 1109290 | 50-111 | Delco-Remy | 43 | 1109791 | 50-111-1 | Delco-Remy | 43 |
| 1109290 | 50-111-1 | Delco-Remy | 43 | 1109794 | 2-2474-DR | Delco-Remy | 43 |
| 1109291 | 50-111 | Delco-Remy | 43 | 1109798 | 50-111 | Delco-Remy | 43 |
| 1109291 | 50-111-1 | Delco-Remy | 43 | 1109798 | 50-111-1 | Delco-Remy | 43 |
| 1109292 | 50-111 | Delco-Remy | 43 | 1109800 | 50-108-1 | Delco-Remy | 41 |
| 1109292 | 50-111-1 | Delco-Remy | 43 | 1109800 | 50-108-2 | Delco-Remy | 41 |
| 1109293 | 50-111 | Delco-Remy | 43 | 1109807 | 50-108-1 | Delco-Remy | 41 |
| 1109293 | 50-111-1 | Delco-Remy | 43 | 1109807 | 50-108-2 | Delco-Remy | 41 |
| 1109293 | 50-111-1 | Delco-Remy | 43 | 1109832 | 2-2474-DR | Delco-Remy | 43 |
| 1109295 | 2-2473-DR | Delco-Remy | 43 | 1109832 | 2-2474-DR | Delco-Remy | 43 |
| 1109296 | 50-111 | Delco-Remy | 43 | 1109837 | 50-111 | Delco-Remy | 43 |
| 1109296 | 50-111-1 | Delco-Remy | 43 | 1109837 | 50-111-1 | Delco-Remy | 43 |
| 1109296 | 50-111-1 | Delco-Remy | 43 | 1109838 | 50-111 | Delco-Remy | 43 |
| 1109298 | 50-111 | Delco-Remy | 43 | 1109838 | 50-111 | Delco-Remy | 43 |
| 1109298 | 50-111-1 | Delco-Remy | 43 | 1109838 | 50-111-1 | Delco-Remy | 43 |
| 1109418 | 2-2753-DR-2 | Delco-Remy | 49 | 1109839 | 50-111 | Delco-Remy | 43 |
| 1109439 | 2-2753-DR-2 | Delco-Remy | 49 | 1109839 | 50-111-1 | Delco-Remy | 43 |
| 1109493 | 50-111 | Delco-Remy | 43 | 1109840 | 50-111 | Delco-Remy | 43 |
| 1109493 | 50-111-1 | Delco-Remy | 43 | 1109840 | 50-111-1 | Delco-Remy | 43 |
| 1109494 | 50-111 | Delco-Remy | 43 | 1109841 | 50-111 | Delco-Remy | 43 |
| 1109494 | 50-111-1 | Delco-Remy | 43 | 1109841 | 50-111-1 | Delco-Remy | 43 |
| 1109494 | 50-111-1 | Delco-Remy | 43 | 1109842 | 50-111 | Delco-Remy | 43 |
| 1109539 | 50-8429 | Delco-Remy | 32 | 1109842 | 50-111-1 | Delco-Remy | 43 |
| 1109545 | 2-2473-DR | Delco-Remy | 43 | 1109843 | 50-111 | Delco-Remy | 43 |
| 1109553 | 50-111 | Delco-Remy | 43 | 1109843 | 50-111-1 | Delco-Remy | 43 |
| 1109553 | 50-111-1 | Delco-Remy | 43 | 1109844 | 50-111 | Delco-Remy | 43 |
| 1109554 | 2-2473-DR | Delco-Remy | 43 | 1109844 | 50-111-1 | Delco-Remy | 43 |
| 1109630 | 50-111 | Delco-Remy | 43 | 1109845 | 50-111 | Delco-Remy | 43 |
| 1109630 | 50-111-1 | Delco-Remy | 43 | 1109845 | 50-111-1 | Delco-Remy | 43 |
| 1109631 | 50-111 | Delco-Remy | 43 | 1109846 | 50-111 | Delco-Remy | 43 |
| 1109631 | 50-111-1 | Delco-Remy | 43 | 1109846 | 50-111-1 | Delco-Remy | 43 |
| 1109635 | 2-2474-DR | Delco-Remy | 43 | 1109961 | 50-111 | Delco-Remy | 43 |
| 1109636 | 50-111 | Delco-Remy | 43 | 1109961 | 50-111-1 | Delco-Remy | 43 |
| 1109636 | 50-111-1 | Delco-Remy | 43 | 1109965 | 50-111 | Delco-Remy | 43 |
| 1109638 | 50-111 | Delco-Remy | 43 | 1109965 | 50-111-1 | Delco-Remy | 43 |
| 1109638 | 50-111-1 | Delco-Remy | 43 | 1109968 | 50-111 | Delco-Remy | 43 |
| 1109642 | 50-111 | Delco-Remy | 43 | 1109968 | 50-111-1 | Delco-Remy | 43 |
| 1109642 | 50-111-1 | Delco-Remy | 43 | 1109971 | 50-111 | Delco-Remy | 43 |
| 1109643 | 50-111 | Delco-Remy | 43 | 1109971 | 50-111-1 | Delco-Remy | 43 |
| 1109643 | 50-111-1 | Delco-Remy | 43 | 1109972 | 50-111 | Delco-Remy | 43 |
| 1109646 | 50-111 | Delco-Remy | 43 | 1109972 | 50-111-1 | Delco-Remy | 43 |
| 1109646 | 50-111-1 | Delco-Remy | 43 | 1109973 | 50-111 | Delco-Remy | 43 |
| 1109647 | 50-111 | Delco-Remy | 43 | 1109973 | 50-111-1 | Delco-Remy | 43 |
| 1109647 | 50-111-1 | Delco-Remy | 43 | 1109977 | 50-111 | Delco-Remy | 43 |
| 1109649 | 50-111 | Delco-Remy | 43 | 1109977 | 50-111-1 | Delco-Remy | 43 |
| 1109649 | 50-111-1 | Delco-Remy | 43 | 1109978 | 50-111 | Delco-Remy | 43 |
| 1109755 | 50-111 | Delco-Remy | 43 | 1109978 | 50-111-1 | Delco-Remy | 43 |
| 1109755 | 50-111-1 | Delco-Remy | 43 | 1109979 | 50-111 | Delco-Remy | 43 |
| 1109759 | 50-111 | Delco-Remy | 43 | 1109979 | 50-111-1 | Delco-Remy | 43 |
| 1109759 | 50-111-1 | Delco-Remy | 43 | 1109985 | 50-111 | Delco-Remy | 43 |
| 1109768 | 50-111 | Delco-Remy | 43 | 1109985 | 50-111-1 | Delco-Remy | 43 |
| 1109768 | 50-111-1 | Delco-Remy | 43 | 1109986 | 50-111 | Delco-Remy | 43 |
| 1109771 | 50-111 | Delco-Remy | 43 | 1109986 | 50-111-1 | Delco-Remy | 43 |
| 1109771 | 50-111-1 | Delco-Remy | 43 | 1109987 | 50-111 | Delco-Remy | 43 |
| 1109772 | 50-111 | Delco-Remy | 43 | 1109987 | 50-111-1 | Delco-Remy | 43 |
| 1109772 | 50-111-1 | Delco-Remy | 43 | 1109988 | 50-111-1 | Delco-Remy | 43 |
| 1109774 | 50-111 | Delco-Remy | 43 | 1109989 | 2-2474-DR | Delco-Remy | 43 |
| 1109774 | 50-111-1 | Delco-Remy | 43 | 11-130-010 | 2-2297-BO | Iskra | 4 |
| 1109775 | 50-111 | Delco-Remy | 43 | 11-130-127 | 50-9900 | Iskra | 49 |
| 1109775 | 50-111 | Delco-Remy | 43 | 11-130-141 | 50-9110-1 | Iskra | 7 |

CROSS REFERENCE

CROSS REFERENCE - REF# to CATALOG#

| Mfr. Part# | Catalog# | Mfr. Name | Pg. # | Mfr. Part# | Catalog# | Mfr. Name | Pg. # |
|------------|-----------|------------|-------|------------|----------|------------|-------|
| 11-130-198 | 50-9900 | Iskra | 49 | 1113827 | 50-103-1 | Delco-Remy | 41 |
| 11-130-199 | 50-9101-1 | Iskra | 6 | 1113827 | 50-103-2 | Delco-Remy | 40 |
| 11-130-203 | 2-2325-BO | Iskra | 5 | 1113831 | 50-104-1 | Delco-Remy | 41 |
| 11-130-229 | 50-9100-1 | Iskra | 5 | 1113831 | 50-104-2 | Delco-Remy | 41 |
| 11-130-322 | 50-9101-1 | Iskra | 6 | 1113840 | 50-103-1 | Delco-Remy | 41 |
| 11-130-366 | 50-9105-1 | Iskra | 6 | 1113840 | 50-103-2 | Delco-Remy | 40 |
| 11-130-409 | 50-9900 | Iskra | 49 | 1113842 | 50-104-1 | Delco-Remy | 41 |
| 11-130-490 | 50-9122-1 | Iskra | 7 | 1113842 | 50-104-2 | Delco-Remy | 41 |
| 11-130-491 | 50-9110-1 | Iskra | 7 | 1113845 | 50-104-1 | Delco-Remy | 41 |
| 11-130-492 | 2-2283-BO | Iskra | 4 | 1113845 | 50-104-2 | Delco-Remy | 41 |
| 11-130-618 | 50-9900 | Iskra | 49 | 1113846 | 50-104-1 | Delco-Remy | 41 |
| 11-131-117 | 2-2666 | Iskra | 109 | 1113846 | 50-104-2 | Delco-Remy | 41 |
| 1113266 | 2-1580-DR | Delco-Remy | 29 | 1113848 | 50-103-1 | Delco-Remy | 41 |
| 1113267 | 50-8402-2 | Delco-Remy | 29 | 1113848 | 50-103-2 | Delco-Remy | 40 |
| 1113269 | 2-1580-DR | Delco-Remy | 29 | 1113849 | 50-104-1 | Delco-Remy | 41 |
| 1113270 | 50-8402-2 | Delco-Remy | 29 | 1113849 | 50-104-2 | Delco-Remy | 41 |
| 1113271 | 50-8422 | Delco-Remy | 31 | 1113850 | 50-104-1 | Delco-Remy | 41 |
| 1113273 | 50-8403 | Delco-Remy | 29 | 1113850 | 50-104-2 | Delco-Remy | 41 |
| 1113274 | 50-8405 | Delco-Remy | 29 | 1113851 | 50-104-1 | Delco-Remy | 41 |
| 1113274 | 50-8431 | Delco-Remy | 32 | 1113851 | 50-104-2 | Delco-Remy | 41 |
| 1113275 | 50-8406-2 | Delco-Remy | 30 | 1113853 | 50-103-1 | Delco-Remy | 41 |
| 1113276 | 50-8407 | Delco-Remy | 30 | 1113853 | 50-103-2 | Delco-Remy | 40 |
| 1113276 | 50-8420 | Delco-Remy | 31 | 1113858 | 50-104-1 | Delco-Remy | 41 |
| 1113277 | 50-8421 | Delco-Remy | 31 | 1113858 | 50-104-2 | Delco-Remy | 41 |
| 1113278 | 50-8406-2 | Delco-Remy | 30 | 1113866 | 50-104-1 | Delco-Remy | 41 |
| 1113279 | 50-8410 | Delco-Remy | 30 | 1113866 | 50-104-2 | Delco-Remy | 41 |
| 1113280 | 50-8410 | Delco-Remy | 30 | 1113872 | 50-104-1 | Delco-Remy | 41 |
| 1113281 | 50-8404 | Delco-Remy | 29 | 1113872 | 50-104-2 | Delco-Remy | 41 |
| 1113282 | 50-8404 | Delco-Remy | 29 | 1113876 | 50-104-1 | Delco-Remy | 41 |
| 1113283 | 2-1750-ND | Delco-Remy | 103 | 1113876 | 50-104-2 | Delco-Remy | 41 |
| 1113284 | 50-8436 | Delco-Remy | 33 | 1113883 | 50-104-1 | Delco-Remy | 41 |
| 1113285 | 50-8429 | Delco-Remy | 32 | 1113883 | 50-104-2 | Delco-Remy | 41 |
| 1113288 | 50-8423 | Delco-Remy | 31 | 1113887 | 50-104-1 | Delco-Remy | 41 |
| 1113290 | 50-8417 | Delco-Remy | 30 | 1113887 | 50-104-2 | Delco-Remy | 41 |
| 1113291 | 50-8421 | Delco-Remy | 31 | 1113893 | 50-104-1 | Delco-Remy | 41 |
| 1113292 | 50-8420 | Delco-Remy | 31 | 1113893 | 50-104-2 | Delco-Remy | 41 |
| 1113295 | 2-1580-DR | Delco-Remy | 29 | 1113895 | 50-104-1 | Delco-Remy | 41 |
| 1113296 | 50-8402-2 | Delco-Remy | 29 | 1113895 | 50-104-2 | Delco-Remy | 41 |
| 1113297 | 50-8415 | Delco-Remy | 30 | 1113900 | 50-104-1 | Delco-Remy | 41 |
| 1113402 | 50-159-1 | Delco-Remy | 36 | 1113900 | 50-104-2 | Delco-Remy | 41 |
| 1113403 | 50-160-1 | Delco-Remy | 36 | 1113901 | 50-103-1 | Delco-Remy | 41 |
| 1113474 | 50-9102 | Delco-Remy | 6 | 1113901 | 50-103-2 | Delco-Remy | 40 |
| 1113479 | 50-160-1 | Delco-Remy | 36 | 1113904 | 50-103-1 | Delco-Remy | 41 |
| 1113481 | 50-160-1 | Delco-Remy | 36 | 1113904 | 50-103-2 | Delco-Remy | 40 |
| 1113486 | 50-160-1 | Delco-Remy | 36 | 1113905 | 50-104-1 | Delco-Remy | 41 |
| 1113534 | 50-160-1 | Delco-Remy | 36 | 1113905 | 50-104-2 | Delco-Remy | 41 |
| 1113535 | 50-160-1 | Delco-Remy | 36 | 1113910 | 50-104-1 | Delco-Remy | 41 |
| 1113536 | 50-160-1 | Delco-Remy | 36 | 1113910 | 50-104-2 | Delco-Remy | 41 |
| 1113584 | 50-160-1 | Delco-Remy | 36 | 1113914 | 50-104-1 | Delco-Remy | 41 |
| 1113585 | 50-160-1 | Delco-Remy | 36 | 1113914 | 50-104-2 | Delco-Remy | 41 |
| 1113593 | 50-157-9 | Delco-Remy | 28 | 1113919 | 50-103-1 | Delco-Remy | 41 |
| 1113640 | 50-159-1 | Delco-Remy | 36 | 1113919 | 50-103-2 | Delco-Remy | 40 |
| 1113641 | 50-159-1 | Delco-Remy | 36 | 1113920 | 50-104-1 | Delco-Remy | 41 |
| 1113644 | 50-159-1 | Delco-Remy | 36 | 1113920 | 50-104-2 | Delco-Remy | 41 |
| 1113648 | 50-159-1 | Delco-Remy | 36 | 1113922 | 50-103-1 | Delco-Remy | 41 |
| 1113650 | 50-159-1 | Delco-Remy | 36 | 1113922 | 50-103-2 | Delco-Remy | 40 |
| 1113651 | 50-159-1 | Delco-Remy | 36 | 1113923 | 50-103-1 | Delco-Remy | 41 |
| 1113653 | 50-159-1 | Delco-Remy | 36 | 1113923 | 50-103-2 | Delco-Remy | 40 |
| 1113656 | 50-159-1 | Delco-Remy | 36 | 1113924 | 50-104-1 | Delco-Remy | 41 |
| 1113668 | 50-159-1 | Delco-Remy | 36 | 1113924 | 50-104-2 | Delco-Remy | 41 |
| 1113672 | 50-159-1 | Delco-Remy | 36 | 1113925 | 50-103-1 | Delco-Remy | 41 |
| 1113676 | 50-159-1 | Delco-Remy | 36 | 1113925 | 50-103-2 | Delco-Remy | 40 |
| 1113683 | 50-159-1 | Delco-Remy | 36 | 1113928 | 50-103-1 | Delco-Remy | 41 |
| 1113690 | 50-159-1 | Delco-Remy | 36 | 1113928 | 50-103-2 | Delco-Remy | 40 |
| 1113809 | 50-108-1 | Delco-Remy | 41 | 1113930 | 50-103-1 | Delco-Remy | 41 |
| 1113809 | 50-108-2 | Delco-Remy | 41 | 1113930 | 50-103-2 | Delco-Remy | 40 |
| 1113818 | 50-104-1 | Delco-Remy | 41 | 1113931 | 50-104-1 | Delco-Remy | 41 |
| 1113818 | 50-104-2 | Delco-Remy | 41 | 1113931 | 50-104-2 | Delco-Remy | 41 |
| 1113824 | 50-104-1 | Delco-Remy | 41 | 1113933 | 50-103-1 | Delco-Remy | 41 |
| 1113824 | 50-104-2 | Delco-Remy | 41 | 1113933 | 50-103-2 | Delco-Remy | 40 |
| 1113825 | 50-104-1 | Delco-Remy | 41 | 1113934 | 50-103-1 | Delco-Remy | 41 |
| 1113825 | 50-104-2 | Delco-Remy | 41 | 1113934 | 50-103-2 | Delco-Remy | 40 |

CROSS REFERENCE

CROSS REFERENCE - REF# to CATALOG#

| Mfr. Part# | Catalog# | Mfr. Name | Pg. # | Mfr. Part# | Catalog# | Mfr. Name | Pg. # |
|------------|-----------|-------------|-------|------------|------------|-------------|-------|
| 1114107 | .50-108-2 | .Delco-Remy | .41 | 1114170 | .50-108-2 | .Delco-Remy | .41 |
| 1114109 | .50-100-1 | .Delco-Remy | .40 | 1114172 | .50-108-1 | .Delco-Remy | .41 |
| 1114109 | .50-100-2 | .Delco-Remy | .40 | 1114172 | .50-108-2 | .Delco-Remy | .41 |
| 1114110 | .50-100-1 | .Delco-Remy | .40 | 1114174 | .50-100-1 | .Delco-Remy | .40 |
| 1114110 | .50-100-2 | .Delco-Remy | .40 | 1114174 | .50-100-2 | .Delco-Remy | .40 |
| 1114113 | .50-108-1 | .Delco-Remy | .41 | 1114175 | .50-100-1 | .Delco-Remy | .40 |
| 1114113 | .50-108-2 | .Delco-Remy | .41 | 1114175 | .50-100-2 | .Delco-Remy | .40 |
| 1114114 | .50-100-1 | .Delco-Remy | .40 | 1114179 | .50-108-1 | .Delco-Remy | .41 |
| 1114114 | .50-100-2 | .Delco-Remy | .40 | 1114179 | .50-108-2 | .Delco-Remy | .41 |
| 1114115 | .50-108-1 | .Delco-Remy | .41 | 1114180 | .50-108-1 | .Delco-Remy | .41 |
| 1114115 | .50-108-2 | .Delco-Remy | .41 | 1114180 | .50-108-2 | .Delco-Remy | .41 |
| 1114117 | .50-100-1 | .Delco-Remy | .40 | 1114185 | .50-108-1 | .Delco-Remy | .41 |
| 1114117 | .50-100-2 | .Delco-Remy | .40 | 1114185 | .50-108-2 | .Delco-Remy | .41 |
| 1114118 | .50-108-1 | .Delco-Remy | .41 | 1114186 | .50-108-1 | .Delco-Remy | .41 |
| 1114118 | .50-108-2 | .Delco-Remy | .41 | 1114186 | .50-108-2 | .Delco-Remy | .41 |
| 1114119 | .50-108-1 | .Delco-Remy | .41 | 1114187 | .50-108-1 | .Delco-Remy | .41 |
| 1114119 | .50-108-2 | .Delco-Remy | .41 | 1114187 | .50-108-2 | .Delco-Remy | .41 |
| 1114122 | .50-108-1 | .Delco-Remy | .41 | 1114188 | .50-108-1 | .Delco-Remy | .41 |
| 1114122 | .50-108-2 | .Delco-Remy | .41 | 1114188 | .50-108-2 | .Delco-Remy | .41 |
| 1114124 | .50-108-1 | .Delco-Remy | .41 | 1114189 | .50-108-1 | .Delco-Remy | .41 |
| 1114124 | .50-108-2 | .Delco-Remy | .41 | 1114189 | .50-108-2 | .Delco-Remy | .41 |
| 1114126 | .50-108-1 | .Delco-Remy | .41 | 1114190 | .50-100-1 | .Delco-Remy | .40 |
| 1114126 | .50-108-2 | .Delco-Remy | .41 | 1114190 | .50-100-2 | .Delco-Remy | .40 |
| 1114127 | .50-100-1 | .Delco-Remy | .40 | 1114193 | .50-108-1 | .Delco-Remy | .41 |
| 1114127 | .50-100-2 | .Delco-Remy | .40 | 1114193 | .50-108-2 | .Delco-Remy | .41 |
| 1114128 | .50-108-1 | .Delco-Remy | .41 | 1114194 | .50-108-1 | .Delco-Remy | .41 |
| 1114128 | .50-108-2 | .Delco-Remy | .41 | 1114194 | .50-108-2 | .Delco-Remy | .41 |
| 1114129 | .50-100-1 | .Delco-Remy | .40 | 1114197 | .50-108-1 | .Delco-Remy | .41 |
| 1114129 | .50-100-2 | .Delco-Remy | .40 | 1114197 | .50-108-2 | .Delco-Remy | .41 |
| 1114130 | .50-108-1 | .Delco-Remy | .41 | 1114199 | .50-100-1 | .Delco-Remy | .40 |
| 1114130 | .50-108-2 | .Delco-Remy | .41 | 1114199 | .50-100-2 | .Delco-Remy | .40 |
| 1114133 | .50-108-1 | .Delco-Remy | .41 | 1114702 | .2-2899-DR | .Delco-Remy | .40 |
| 1114133 | .50-108-2 | .Delco-Remy | .41 | 1114703 | .50-100-1 | .Delco-Remy | .40 |
| 1114136 | .50-100-1 | .Delco-Remy | .40 | 1114703 | .50-100-2 | .Delco-Remy | .40 |
| 1114136 | .50-100-2 | .Delco-Remy | .40 | 1114705 | .50-100-1 | .Delco-Remy | .40 |
| 1114138 | .50-100-1 | .Delco-Remy | .40 | 1114705 | .50-100-2 | .Delco-Remy | .40 |
| 1114138 | .50-100-2 | .Delco-Remy | .40 | 1114706 | .50-103-1 | .Delco-Remy | .41 |
| 1114140 | .50-108-1 | .Delco-Remy | .41 | 1114706 | .50-103-2 | .Delco-Remy | .40 |
| 1114140 | .50-108-2 | .Delco-Remy | .41 | 1114708 | .50-100-1 | .Delco-Remy | .40 |
| 1114141 | .50-100-1 | .Delco-Remy | .40 | 1114708 | .50-100-2 | .Delco-Remy | .40 |
| 1114141 | .50-100-2 | .Delco-Remy | .40 | 1114710 | .50-104-1 | .Delco-Remy | .41 |
| 1114143 | .50-108-1 | .Delco-Remy | .41 | 1114710 | .50-104-2 | .Delco-Remy | .41 |
| 1114143 | .50-108-2 | .Delco-Remy | .41 | 1114711 | .50-103-1 | .Delco-Remy | .41 |
| 1114144 | .50-100-1 | .Delco-Remy | .40 | 1114711 | .50-103-2 | .Delco-Remy | .40 |
| 1114144 | .50-100-2 | .Delco-Remy | .40 | 1114712 | .50-103-1 | .Delco-Remy | .41 |
| 1114145 | .50-108-1 | .Delco-Remy | .41 | 1114712 | .50-103-2 | .Delco-Remy | .40 |
| 1114145 | .50-108-2 | .Delco-Remy | .41 | 1114714 | .50-100-1 | .Delco-Remy | .40 |
| 1114148 | .50-108-1 | .Delco-Remy | .41 | 1114714 | .50-100-2 | .Delco-Remy | .40 |
| 1114148 | .50-108-2 | .Delco-Remy | .41 | 1114715 | .50-104-1 | .Delco-Remy | .41 |
| 1114149 | .50-100-1 | .Delco-Remy | .40 | 1114715 | .50-104-2 | .Delco-Remy | .41 |
| 1114149 | .50-100-2 | .Delco-Remy | .40 | 1114720 | .50-108-1 | .Delco-Remy | .41 |
| 1114150 | .50-108-1 | .Delco-Remy | .41 | 1114720 | .50-108-2 | .Delco-Remy | .41 |
| 1114150 | .50-108-2 | .Delco-Remy | .41 | 1114722 | .50-108-1 | .Delco-Remy | .41 |
| 1114153 | .50-100-1 | .Delco-Remy | .40 | 1114722 | .50-108-2 | .Delco-Remy | .41 |
| 1114153 | .50-100-2 | .Delco-Remy | .40 | 1114723 | .50-108-1 | .Delco-Remy | .41 |
| 1114156 | .50-100-1 | .Delco-Remy | .40 | 1114723 | .50-108-2 | .Delco-Remy | .41 |
| 1114156 | .50-100-2 | .Delco-Remy | .40 | 1114724 | .50-100-1 | .Delco-Remy | .40 |
| 1114157 | .50-108-1 | .Delco-Remy | .41 | 1114724 | .50-100-2 | .Delco-Remy | .40 |
| 1114157 | .50-108-2 | .Delco-Remy | .41 | 1114725 | .50-108-1 | .Delco-Remy | .41 |
| 1114158 | .50-100-1 | .Delco-Remy | .40 | 1114725 | .50-108-2 | .Delco-Remy | .41 |
| 1114158 | .50-100-2 | .Delco-Remy | .40 | 1114726 | .50-108-1 | .Delco-Remy | .41 |
| 1114162 | .50-100-1 | .Delco-Remy | .40 | 1114726 | .50-108-2 | .Delco-Remy | .41 |
| 1114162 | .50-100-2 | .Delco-Remy | .40 | 1114728 | .50-104-1 | .Delco-Remy | .41 |
| 1114164 | .50-108-1 | .Delco-Remy | .41 | 1114728 | .50-104-2 | .Delco-Remy | .41 |
| 1114164 | .50-108-2 | .Delco-Remy | .41 | 1114729 | .50-103-1 | .Delco-Remy | .41 |
| 1114165 | .50-108-1 | .Delco-Remy | .41 | 1114729 | .50-103-2 | .Delco-Remy | .40 |
| 1114165 | .50-108-2 | .Delco-Remy | .41 | 1114730 | .50-104-1 | .Delco-Remy | .41 |
| 1114167 | .50-100-1 | .Delco-Remy | .40 | 1114730 | .50-104-2 | .Delco-Remy | .41 |
| 1114167 | .50-100-2 | .Delco-Remy | .40 | 1114732 | .50-108-1 | .Delco-Remy | .41 |
| 1114169 | .50-100-1 | .Delco-Remy | .40 | 1114732 | .50-108-2 | .Delco-Remy | .41 |
| 1114169 | .50-100-2 | .Delco-Remy | .40 | 1114734 | .50-100-2 | .Delco-Remy | .40 |
| 1114170 | .50-108-1 | .Delco-Remy | .41 | 1114735 | .50-103-1 | .Delco-Remy | .41 |

CROSS REFERENCE

CROSS REFERENCE - REF# to CATALOG#

| Mfr. Part No. | Catalog No. | Mfr. Name | Pg. # | Mfr. Part No. | Catalog No. | Mfr. Name | Pg. # |
|---------------|-------------|------------|-------|---------------|-------------|------------|-------|
| 1114735 | .50-103-2 | Delco-Remy | 40 | 1114801 | .50-108-2 | Delco-Remy | 41 |
| 1114737 | .50-104-1 | Delco-Remy | 41 | 1114803 | .50-108-1 | Delco-Remy | 41 |
| 1114737 | .50-104-2 | Delco-Remy | 41 | 1114803 | .50-108-2 | Delco-Remy | 41 |
| 1114738 | .50-104-1 | Delco-Remy | 41 | 1114804 | .50-108-1 | Delco-Remy | 41 |
| 1114738 | .50-104-2 | Delco-Remy | 41 | 1114804 | .50-108-2 | Delco-Remy | 41 |
| 1114740 | .50-103-1 | Delco-Remy | 41 | 1114805 | .50-103-1 | Delco-Remy | 41 |
| 1114740 | .50-103-2 | Delco-Remy | 40 | 1114805 | .50-103-2 | Delco-Remy | 40 |
| 1114741 | .50-108-1 | Delco-Remy | 41 | 1114806 | .50-108-1 | Delco-Remy | 41 |
| 1114741 | .50-108-2 | Delco-Remy | 41 | 1114806 | .50-108-2 | Delco-Remy | 41 |
| 1114742 | .50-103-1 | Delco-Remy | 41 | 1114808 | 2-2899-DR | Delco-Remy | 40 |
| 1114742 | .50-103-2 | Delco-Remy | 40 | 1114812 | .50-108-1 | Delco-Remy | 41 |
| 1114743 | .50-103-1 | Delco-Remy | 41 | 1114812 | .50-108-2 | Delco-Remy | 41 |
| 1114743 | .50-103-2 | Delco-Remy | 40 | 1114813 | .50-108-1 | Delco-Remy | 41 |
| 1114747 | .50-108-1 | Delco-Remy | 41 | 1114813 | .50-108-2 | Delco-Remy | 41 |
| 1114747 | .50-108-2 | Delco-Remy | 41 | 1114814 | .50-108-1 | Delco-Remy | 41 |
| 1114748 | .50-100-1 | Delco-Remy | 40 | 1114814 | .50-108-2 | Delco-Remy | 41 |
| 1114748 | .50-100-2 | Delco-Remy | 40 | 1114815 | .50-108-1 | Delco-Remy | 41 |
| 1114749 | .50-108-1 | Delco-Remy | 41 | 1114815 | .50-108-2 | Delco-Remy | 41 |
| 1114749 | .50-108-2 | Delco-Remy | 41 | 1114816 | .50-108-1 | Delco-Remy | 41 |
| 1114750 | .50-108-1 | Delco-Remy | 41 | 1114816 | .50-108-2 | Delco-Remy | 41 |
| 1114750 | .50-108-2 | Delco-Remy | 41 | 1114819 | .50-108-1 | Delco-Remy | 41 |
| 1114751 | .50-108-1 | Delco-Remy | 41 | 1114819 | .50-108-2 | Delco-Remy | 41 |
| 1114751 | .50-108-2 | Delco-Remy | 41 | 1114820 | .50-108-1 | Delco-Remy | 41 |
| 1114752 | .50-108-1 | Delco-Remy | 41 | 1114820 | .50-108-2 | Delco-Remy | 41 |
| 1114752 | .50-108-2 | Delco-Remy | 41 | 1114823 | .50-100-1 | Delco-Remy | 40 |
| 1114753 | .50-100-1 | Delco-Remy | 40 | 1114823 | .50-100-2 | Delco-Remy | 40 |
| 1114753 | .50-100-2 | Delco-Remy | 40 | 1114824 | .50-100-1 | Delco-Remy | 40 |
| 1114754 | .50-100-1 | Delco-Remy | 40 | 1114825 | .50-100-1 | Delco-Remy | 40 |
| 1114754 | .50-100-2 | Delco-Remy | 40 | 1114827 | .50-100-1 | Delco-Remy | 40 |
| 1114755 | .50-104-1 | Delco-Remy | 41 | 1114827 | .50-100-2 | Delco-Remy | 40 |
| 1114755 | .50-104-2 | Delco-Remy | 41 | 1114828 | .50-100-1 | Delco-Remy | 40 |
| 1114756 | .50-104-1 | Delco-Remy | 41 | 1114828 | .50-100-2 | Delco-Remy | 40 |
| 1114756 | .50-104-2 | Delco-Remy | 41 | 1114832 | .50-100-1 | Delco-Remy | 40 |
| 1114759 | .50-103-1 | Delco-Remy | 41 | 1114832 | .50-100-2 | Delco-Remy | 40 |
| 1114759 | .50-103-2 | Delco-Remy | 40 | 1114834 | .50-100-1 | Delco-Remy | 40 |
| 1114760 | .50-104-1 | Delco-Remy | 41 | 1114834 | .50-100-2 | Delco-Remy | 40 |
| 1114760 | .50-104-2 | Delco-Remy | 41 | 1114835 | .50-100-1 | Delco-Remy | 40 |
| 1114761 | .50-108-1 | Delco-Remy | 41 | 1114835 | .50-100-2 | Delco-Remy | 40 |
| 1114761 | .50-108-2 | Delco-Remy | 41 | 1114842 | .50-104-1 | Delco-Remy | 41 |
| 1114762 | .50-104-1 | Delco-Remy | 41 | 1114842 | .50-104-2 | Delco-Remy | 41 |
| 1114762 | .50-104-2 | Delco-Remy | 41 | 1114843 | .50-103-1 | Delco-Remy | 41 |
| 1114767 | .50-103-1 | Delco-Remy | 41 | 1114843 | .50-103-2 | Delco-Remy | 40 |
| 1114767 | .50-103-2 | Delco-Remy | 40 | 1114844 | .50-104-1 | Delco-Remy | 41 |
| 1114769 | .50-108-1 | Delco-Remy | 41 | 1114844 | .50-104-2 | Delco-Remy | 41 |
| 1114769 | .50-108-2 | Delco-Remy | 41 | 1114845 | .50-103-1 | Delco-Remy | 41 |
| 1114772 | .50-103-1 | Delco-Remy | 41 | 1114845 | .50-103-2 | Delco-Remy | 40 |
| 1114772 | .50-103-2 | Delco-Remy | 40 | 1114846 | .50-104-1 | Delco-Remy | 41 |
| 1114774 | .50-103-1 | Delco-Remy | 41 | 1114846 | .50-104-2 | Delco-Remy | 41 |
| 1114774 | .50-103-2 | Delco-Remy | 40 | 1114847 | .50-104-1 | Delco-Remy | 41 |
| 1114777 | .50-103-1 | Delco-Remy | 41 | 1114847 | .50-104-2 | Delco-Remy | 41 |
| 1114777 | .50-103-2 | Delco-Remy | 40 | 1114848 | .50-104-1 | Delco-Remy | 41 |
| 1114782 | .50-103-1 | Delco-Remy | 41 | 1114848 | .50-104-2 | Delco-Remy | 41 |
| 1114782 | .50-103-2 | Delco-Remy | 40 | 1114849 | .50-104-1 | Delco-Remy | 41 |
| 1114788 | .50-108-1 | Delco-Remy | 41 | 1114849 | .50-104-2 | Delco-Remy | 41 |
| 1114788 | .50-108-2 | Delco-Remy | 41 | 1114850 | .50-104-1 | Delco-Remy | 41 |
| 1114790 | .50-104-1 | Delco-Remy | 41 | 1114850 | .50-104-2 | Delco-Remy | 41 |
| 1114790 | .50-104-2 | Delco-Remy | 41 | 1114852 | .50-104-1 | Delco-Remy | 41 |
| 1114791 | .50-108-1 | Delco-Remy | 41 | 1114852 | .50-104-2 | Delco-Remy | 41 |
| 1114791 | .50-108-2 | Delco-Remy | 41 | 1114853 | .50-104-1 | Delco-Remy | 41 |
| 1114793 | .50-103-1 | Delco-Remy | 41 | 1114853 | .50-104-2 | Delco-Remy | 41 |
| 1114793 | .50-103-2 | Delco-Remy | 40 | 1114854 | .50-104-1 | Delco-Remy | 41 |
| 1114795 | .50-108-1 | Delco-Remy | 41 | 1114854 | .50-104-2 | Delco-Remy | 41 |
| 1114795 | .50-108-2 | Delco-Remy | 41 | 1114855 | .50-104-1 | Delco-Remy | 41 |
| 1114797 | .50-108-1 | Delco-Remy | 41 | 1114855 | .50-104-2 | Delco-Remy | 41 |
| 1114797 | .50-108-2 | Delco-Remy | 41 | 1114856 | .50-103-1 | Delco-Remy | 41 |
| 1114798 | .50-108-1 | Delco-Remy | 41 | 1114856 | .50-103-2 | Delco-Remy | 40 |
| 1114798 | .50-108-2 | Delco-Remy | 41 | 1114857 | .50-103-1 | Delco-Remy | 41 |
| 1114799 | .50-108-1 | Delco-Remy | 41 | 1114857 | .50-103-2 | Delco-Remy | 40 |
| 1114799 | .50-108-2 | Delco-Remy | 41 | 1114858 | .50-103-1 | Delco-Remy | 41 |
| 1114800 | .50-108-1 | Delco-Remy | 41 | 1114858 | .50-103-2 | Delco-Remy | 40 |
| 1114800 | .50-108-2 | Delco-Remy | 41 | 1114859 | .50-103-1 | Delco-Remy | 41 |
| 1114801 | .50-108-1 | Delco-Remy | 41 | 1114859 | .50-103-2 | Delco-Remy | 40 |

CROSS REFERENCE

CROSS REFERENCE - REF# to CATALOG#

| Mfr. Part No. | Catalog No. | Mfr. Name | Pg. # | Mfr. Part No. | Catalog No. | Mfr. Name | Pg. # |
|---------------|-------------|------------|-------|---------------|---------------|------------|-------|
| 1114985 | 50-108-1 | Delco-Remy | 41 | 1117801 | 20-1163-1 | Delco-Remy | 19 |
| 1114985 | 50-108-2 | Delco-Remy | 41 | 1117803 | 20-131-1 | Delco-Remy | 18 |
| 1114986 | 50-100-1 | Delco-Remy | 40 | 1117804 | 20-131-1 | Delco-Remy | 18 |
| 1114986 | 50-100-2 | Delco-Remy | 40 | 1117805 | 20-132-1 | Delco-Remy | 18 |
| 1114987 | 50-104-1 | Delco-Remy | 41 | 1117808 | 20-131-1 | Delco-Remy | 18 |
| 1114987 | 50-104-2 | Delco-Remy | 41 | 1117809 | 20-1163-1 | Delco-Remy | 19 |
| 1114989 | 50-103-1 | Delco-Remy | 41 | 1117811 | 20-1163-1 | Delco-Remy | 19 |
| 1114989 | 50-103-2 | Delco-Remy | 40 | 1117812 | 20-1163-1 | Delco-Remy | 19 |
| 1114990 | 50-108-1 | Delco-Remy | 41 | 1117813 | 20-1163-1 | Delco-Remy | 19 |
| 1114990 | 50-108-2 | Delco-Remy | 41 | 1117814 | 20-133-1 | Delco-Remy | 18 |
| 1114993 | 50-108-1 | Delco-Remy | 41 | 1117815 | 20-131-1 | Delco-Remy | 18 |
| 1114993 | 50-108-2 | Delco-Remy | 41 | 1117816 | 20-1163-1 | Delco-Remy | 19 |
| 1114999 | 50-108-1 | Delco-Remy | 41 | 1117820 | 20-1163-1 | Delco-Remy | 19 |
| 1114999 | 50-108-2 | Delco-Remy | 41 | 1117821 | 20-132-1 | Delco-Remy | 18 |
| 1117067 | 20-133-1 | Delco-Remy | 18 | 1117830 | 20-1163-1 | Delco-Remy | 19 |
| 1117068 | 20-133-1 | Delco-Remy | 18 | 1117831 | 20-132-1 | Delco-Remy | 18 |
| 1117069 | 20-178-1 | Delco-Remy | 17 | 1117833 | 20-133-1 | Delco-Remy | 18 |
| 1117225 | 20-119-1 | Delco-Remy | 16 | 1117836 | 20-132-1 | Delco-Remy | 18 |
| 1117226 | 20-121-1 | Delco-Remy | 16 | 1117838 | 20-132-1 | Delco-Remy | 18 |
| 1117227 | 20-119-1 | Delco-Remy | 16 | 1117880 | 1-1915-00DR | Delco-Remy | 11 |
| 1117228 | 20-119-1 | Delco-Remy | 16 | 1117882 | 1-1918-00DR | Delco-Remy | 12 |
| 1117231 | 20-119-1 | Delco-Remy | 16 | 1117885 | 1-2333-00DR | Delco-Remy | 14 |
| 1117234 | 20-119-1 | Delco-Remy | 16 | 1117886 | 1-2333-00DR | Delco-Remy | 14 |
| 1117236 | 20-121-1 | Delco-Remy | 16 | 1117887 | 1-2333-00DR | Delco-Remy | 14 |
| 1117238 | 20-178-1 | Delco-Remy | 17 | 1117889 | 1-1915-00DR | Delco-Remy | 11 |
| 1117239 | 20-121-1 | Delco-Remy | 16 | 1117890 | 1-2333-00DR | Delco-Remy | 14 |
| 1117240 | 20-119-1 | Delco-Remy | 16 | 1117892 | 1-2333-00DR | Delco-Remy | 14 |
| 1117241 | 20-119-1 | Delco-Remy | 16 | 1117893 | 1-1918-00DR | Delco-Remy | 12 |
| 1117242 | 20-119-1 | Delco-Remy | 16 | 1117894 | 1-1915-00DR | Delco-Remy | 11 |
| 1117244 | 20-119-1 | Delco-Remy | 16 | 1117895 | 1-1916-00DR | Delco-Remy | 12 |
| 1117248 | 20-121-1 | Delco-Remy | 16 | 1117896 | 1-1917-00DR | Delco-Remy | 12 |
| 1117249 | 20-178-1 | Delco-Remy | 17 | 1117897 | 1-2291-00DR | Delco-Remy | 12 |
| 1117250 | 20-121-1 | Delco-Remy | 16 | 1117900 | 1-2291-00DR | Delco-Remy | 12 |
| 1117251 | 20-119-1 | Delco-Remy | 16 | 1117903 | 1-1916-00DR | Delco-Remy | 12 |
| 1117253 | 20-121-1 | Delco-Remy | 16 | 1117904 | 1-1917-00DR | Delco-Remy | 12 |
| 1117255 | 20-119-1 | Delco-Remy | 16 | 1117905 | 1-2300-00DR | Delco-Remy | 14 |
| 1117256 | 20-178-1 | Delco-Remy | 17 | 1117906 | 1-1915-00DR | Delco-Remy | 11 |
| 1117258 | 20-121-1 | Delco-Remy | 16 | 1117907 | 1-1916-00DR | Delco-Remy | 12 |
| 1117259 | 20-119-1 | Delco-Remy | 16 | 1117908 | 1-1917-00DR | Delco-Remy | 12 |
| 1117260 | 20-119-1 | Delco-Remy | 16 | 1117909 | 1-2300-00DR | Delco-Remy | 14 |
| 1117261 | 20-119-1 | Delco-Remy | 16 | 1117910 | 1-2333-00DR | Delco-Remy | 14 |
| 1117262 | 20-119-1 | Delco-Remy | 16 | 1117911 | 1-1918-00DR | Delco-Remy | 12 |
| 1117263 | 20-119-1 | Delco-Remy | 16 | 1117914 | 1-1918-00DR | Delco-Remy | 12 |
| 1117267 | 20-119-1 | Delco-Remy | 16 | 1117915 | 1-2292-00DR | Delco-Remy | 12 |
| 1117274 | 1-2301-00DR | Delco-Remy | 17 | 1117916 | 1-2299-00DR | Delco-Remy | 13 |
| 1117280 | 1-2301-00DR | Delco-Remy | 17 | 1117917 | 1-2334-00DR | Delco-Remy | 14 |
| 1117481 | 20-133-1 | Delco-Remy | 18 | 1117917 | 1-2334-00DR-3 | Delco-Remy | 14 |
| 1117483 | 20-133-1 | Delco-Remy | 18 | 1117919 | 1-2334-00DR | Delco-Remy | 14 |
| 1117484 | 20-133-1 | Delco-Remy | 18 | 1117919 | 1-2334-00DR-3 | Delco-Remy | 14 |
| 1117611 | 20-117-1 | Delco-Remy | 11 | 1117920 | 1-2334-00DR | Delco-Remy | 14 |
| 1117612 | 20-117-1 | Delco-Remy | 11 | 1117920 | 1-2334-00DR-3 | Delco-Remy | 14 |
| 1117613 | 20-117-1 | Delco-Remy | 11 | 1117921 | 1-2334-00DR | Delco-Remy | 14 |
| 1117615 | 20-118-1 | Delco-Remy | 11 | 1117921 | 1-2334-00DR-3 | Delco-Remy | 14 |
| 1117616 | 20-117-1 | Delco-Remy | 11 | 1117922 | 1-2334-00DR | Delco-Remy | 14 |
| 1117618 | 20-117-1 | Delco-Remy | 11 | 1117922 | 1-2334-00DR-3 | Delco-Remy | 14 |
| 1117619 | 20-118-1 | Delco-Remy | 11 | 1117923 | 1-2333-00DR | Delco-Remy | 14 |
| 1117621 | 20-117-1 | Delco-Remy | 11 | 1117924 | 1-2299-00DR | Delco-Remy | 13 |
| 1117628 | 20-117-1 | Delco-Remy | 11 | 1117925 | 1-1915-00DR | Delco-Remy | 11 |
| 1117640 | 20-118-1 | Delco-Remy | 11 | 1117927 | 1-1916-00DR | Delco-Remy | 12 |
| 1117641 | 20-117-1 | Delco-Remy | 11 | 1117928 | 1-1917-00DR | Delco-Remy | 12 |
| 1117642 | 20-118-1 | Delco-Remy | 11 | 1117929 | 1-1918-00DR | Delco-Remy | 12 |
| 1117643 | 20-118-1 | Delco-Remy | 11 | 1117930 | 1-1915-00DR | Delco-Remy | 11 |
| 1117644 | 20-118-1 | Delco-Remy | 11 | 1117931 | 1-1915-00DR | Delco-Remy | 11 |
| 1117645 | 20-118-1 | Delco-Remy | 11 | 1117932 | 1-1918-00DR | Delco-Remy | 12 |
| 1117647 | 20-118-1 | Delco-Remy | 11 | 1117933 | 1-2299-00DR | Delco-Remy | 13 |
| 1117650 | 20-118-1 | Delco-Remy | 11 | 1117934 | 1-2334-00DR | Delco-Remy | 14 |
| 1117655 | 20-118-1 | Delco-Remy | 11 | 1117934 | 1-2334-00DR-3 | Delco-Remy | 14 |
| 1117732 | 20-131-1 | Delco-Remy | 18 | 1117937 | 1-2300-00DR | Delco-Remy | 14 |
| 1117736 | 20-131-1 | Delco-Remy | 18 | 1117941 | 1-2333-00DR | Delco-Remy | 14 |
| 1117742 | 20-131-1 | Delco-Remy | 18 | 1117942 | 1-1915-00DR | Delco-Remy | 11 |
| 1117744 | 20-133-1 | Delco-Remy | 18 | 1117943 | 1-2300-00DR | Delco-Remy | 14 |
| 1117800 | 20-131-1 | Delco-Remy | 18 | 1117946 | 1-1918-00DR | Delco-Remy | 12 |

CROSS REFERENCE

CROSS REFERENCE - REF# to CATALOG#

| Mfr. Part# | Catalog# | Mfr. Name | Pg. # | Mfr. Part# | Catalog# | Mfr. Name | Pg. # |
|----------------|---------------|-----------------|-------|------------|-------------|-----------|-------|
| 1117947 | 1-1915-00DR | Delco-Remy | 11 | 120-513 | 50-9109-1 | PIC | 6 |
| 1117948 | 1-2299-00DR | Delco-Remy | 13 | 120-514 | 50-9100-1 | PIC | 5 |
| 1117949 | 1-1918-00DR | Delco-Remy | 12 | 120-516 | 50-9109-1 | PIC | 6 |
| 1117950 | 1-1915-00DR | Delco-Remy | 11 | 120-518 | 50-9100-1 | PIC | 5 |
| 1117951 | 1-1915-00DR | Delco-Remy | 11 | 120-518A | 50-9100-1 | PIC | 5 |
| 1117952 | 1-2299-00DR | Delco-Remy | 13 | 120-518B | 50-9100-1 | PIC | 5 |
| 1117953 | 1-1915-00DR | Delco-Remy | 11 | 120-518C | 50-9100-1 | PIC | 5 |
| 1117954 | 1-1915-00DR | Delco-Remy | 11 | 120-520 | 50-9110-1 | PIC | 7 |
| 1117955 | 1-1915-00DR | Delco-Remy | 11 | 120-520A | 50-9110-1 | PIC | 7 |
| 1117956 | 1-1915-00DR | Delco-Remy | 11 | 120-520B | 50-9110-1 | PIC | 7 |
| 1117957 | 1-1918-00DR | Delco-Remy | 12 | 120-520C | 50-9110-1 | PIC | 7 |
| 1117958 | 1-1918-00DR | Delco-Remy | 12 | 120-520D | 50-9110-1 | PIC | 7 |
| 1117959 | 1-1918-00DR | Delco-Remy | 12 | 120-521 | 50-9124-1 | PIC | 7 |
| 1117962 | 1-1918-00DR | Delco-Remy | 12 | 120-521A | 50-9124-1 | PIC | 7 |
| 1117964 | 1-2334-00DR | Delco-Remy | 14 | 120-521B | 50-9124-1 | PIC | 7 |
| 1117964 | 1-2334-00DR-3 | Delco-Remy | 14 | 120-521N | 50-9124-1 | PIC | 7 |
| 1117965 | 1-2300-00DR | Delco-Remy | 14 | 120-522 | 2-2669-BO | PIC | 5 |
| 1117966 | 1-2300-00DR | Delco-Remy | 14 | 120-523 | 50-9107 | PIC | 6 |
| 11180180 | 2-1946-BO | Deutz-Allis | 7 | 120-524 | 50-9100-1 | PIC | 5 |
| 11-201-989 | 1-2435-01BO | Iskra | 73 | 120-526 | 50-9101-1 | PIC | 6 |
| 11-203-087 | 1-2455-01MM | Iskra | 73 | 120-526A | 50-9101-1 | PIC | 6 |
| 11-212-108 | 82-7860 | Iskra | 118 | 120-527 | 2-2707-BO-2 | PIC | 5 |
| 112123 | 50-9115 | Fiat | 7 | 120-527A | 2-2707-BO-2 | PIC | 5 |
| 11-212-385 | 82-7861 | Iskra | 118 | 120-528 | 50-9105-1 | PIC | 6 |
| 11-212-721 | 82-6863 | Iskra | 115 | 120-529 | 50-9107 | PIC | 6 |
| 11234 | 1-2878-01BO | Lester | 3 | 120-530 | 50-9124-1 | PIC | 7 |
| 1132 | 20-9900 | Electroprecizia | 49 | 120-533 | 50-9102 | PIC | 6 |
| 1146864 | 2-2087-MI | Caterpillar | 89 | 120-535 | 50-9900 | PIC | 49 |
| 1146864 | 2-2087-MI-1 | Caterpillar | 89 | 120-535A | 50-9900 | PIC | 49 |
| 1161384 | 50-9109-1 | KHD | 6 | 120-543 | 50-9105-1 | PIC | 6 |
| 1161384 | 50-9124-1 | KHD | 7 | 120-565 | 2-2283-BO | PIC | 4 |
| 1161422 | 50-9110-1 | KHD | 7 | 120-565A | 2-2283-BO | PIC | 4 |
| 1161890 | 50-9107 | KHD | 6 | 120-565B | 2-2283-BO | PIC | 4 |
| 1162504 | 50-9115 | KHD | 7 | 120-567 | 50-9108 | PIC | 6 |
| 1162505 | 50-9115 | KHD | 7 | 120-570 | 2-2284-BO | PIC | 4 |
| 1162506 | 50-9115 | KHD | 7 | 120-570A | 2-2284-BO | PIC | 4 |
| 1163669 | 50-9124-1 | KHD | 7 | 120-570C | 2-2284-BO | PIC | 4 |
| 1164668 | 50-9124-1 | KHD | 7 | 120-571 | 50-9122-1 | PIC | 7 |
| 1164994 | 50-9109-1 | KHD | 6 | 120-571A | 50-9122-1 | PIC | 7 |
| 1164994 | 50-9124-1 | KHD | 7 | 120-582 | 50-9115 | PIC | 7 |
| 1164995 | 50-9110-1 | KHD | 7 | 120-582A | 50-9115 | PIC | 7 |
| 116930A1 | 2-1726-ND-2 | Case | 102 | 120-582B | 50-9115 | PIC | 7 |
| 1171203 | 50-9115 | KHD | 7 | 120-582D | 50-9115 | PIC | 7 |
| 1171481 | 50-9107 | KHD | 6 | 120-582E | 50-9115 | PIC | 7 |
| 1172099 | 50-9110-1 | KHD | 7 | 120-589 | 50-9117 | PIC | 7 |
| 1173240 | 50-9124-1 | KHD | 7 | 120-589A | 50-9117 | PIC | 7 |
| 1173820 | 50-9110-1 | KHD | 7 | 120-589B | 50-9117 | PIC | 7 |
| 1174166 | 50-9124-1 | KHD | 7 | 120-589C | 50-9117 | PIC | 7 |
| 1178026 | 50-9124-1 | KHD | 7 | 120-589D | 50-9117 | PIC | 7 |
| 1178511 | 1-2711-00BO | KHD | 2 | 120-589E | 50-9117 | PIC | 7 |
| 1178511 | 1-2711-01BO | KHD | 2 | 120-589F | 50-9117 | PIC | 7 |
| 1178686 | 50-9124-1 | KHD | 7 | 120-597 | 2-2325-BO | PIC | 5 |
| 1180180 | 2-1946-BO | KHD | 7 | 120-597A | 2-2325-BO | PIC | 5 |
| 118-0180 | 2-1946-BO | KHD | 7 | 120-597B | 2-2325-BO | PIC | 5 |
| 1180928 | 2-2736-BO-2 | KHD | 8 | 120-597C | 2-2325-BO | PIC | 5 |
| 1180995 | 2-1946-BO | KHD | 7 | 12060 | 20-121-1 | Lester | 16 |
| 1185AC | 82-6885 | Fenner Stone | 117 | 120-6018 | 2-2299-BO | PIC | 5 |
| 1185AC | 82-7851 | Fenner Stone | 118 | 120-6018A | 2-2299-BO | PIC | 5 |
| 119836-77200 | 1-2315-01 | Yanmar | 68 | 120-6018B | 2-2299-BO | PIC | 5 |
| 119836-77200-2 | 1-2315-01 | Yanmar | 68 | 120-6030 | 2-2362-BO | PIC | 8 |
| 119836-77200-3 | 1-2315-01 | Yanmar | 68 | 120-6039 | 2-2298-BO | PIC | 4 |
| 120-149 | 2-1946-BO | PIC | 7 | 120-6045 | 2-2736-BO-2 | PIC | 8 |
| 120-149A | 2-1946-BO | PIC | 7 | 120-6048 | 2-2285-BO | PIC | 4 |
| 120-151 | 2-2553-BO | PIC | 8 | 120-6050 | 2-2301-LU | PIC | 78 |
| 12046 | 1-2762-01LU | Lester | 77 | 120-6057B | 2-2680-BO | PIC | 5 |
| 120-486 | 2-2690-BO | PIC | 9 | 120-6058 | 2-2297-BO | PIC | 4 |
| 120-497 | 2-1803-BO-2 | PIC | 4 | 120-6058A | 2-2297-BO | PIC | 4 |
| 120-497A | 2-1803-BO-2 | PIC | 4 | 120-6058B | 2-2297-BO | PIC | 4 |
| 120-498 | 2-1803-BO-2 | PIC | 4 | 120-6058D | 2-2297-BO | PIC | 4 |
| 120-499 | 2-1803-BO-2 | PIC | 4 | 120-6060 | 2-2770-NK | PIC | 94 |
| 120-5060 | 2-2463-BO | PIC | 8 | 120-6063 | 2-2301-LU | PIC | 78 |
| 120-507 | 50-9124-1 | PIC | 7 | 120-6067 | 2-2297-BO | PIC | 4 |

CROSS REFERENCE

CROSS REFERENCE - REF# to CATALOG#

| Mfr. Part No. | Catalog No. | Mfr. Name | Pg. # | Mfr. Part No. | Catalog No. | Mfr. Name | Pg. # |
|---------------|---------------|-------------|-------|---------------|---------------|-------------|-------|
| 120-6075 | 50-100-1 | PIC | 40 | 12199 | 1-2478-01ND | Lester | 99 |
| 120-6075 | 50-100-2 | PIC | 40 | 12210 | 1-2822-01ND-2 | Lester | 99 |
| 120-6088A | 50-9115 | PIC | 7 | 12231 | 1-2392-01MI | Lester | 84 |
| 120-6092 | 50-9115 | PIC | 7 | 12234 | 1-2470-01HI | Lester | 66 |
| 120-6123 | 2-2292-LU | PIC | 80 | 12235 | 1-2495-01HI | Lester | 68 |
| 120-6123 | 2-2292-LU-1 | PIC | 80 | 12237 | 1-2317-01HI | Lester | 66 |
| 120-6140 | 2-2355-BO | PIC | 8 | 1226032 | 2-2280-ND | Caterpillar | 101 |
| 120-6140 | 2-2355-BO-1 | PIC | 8 | 12279 | 1-2469-01HI | Lester | 68 |
| 120-6140A | 2-2355-BO | PIC | 8 | 12288 | 1-2314-01HI | Lester | 66 |
| 120-6140A | 2-2355-BO-1 | PIC | 8 | 12301277 | 2-2596-DR-2 | Delco-Remy | 49 |
| 120-6199 | 50-9117 | PIC | 7 | 12301387 | 50-159-1 | Delco-Remy | 36 |
| 120-6199A | 50-9117 | PIC | 7 | 12301389 | 50-159-1 | Delco-Remy | 36 |
| 12066 | 1-2851-01ND | Lester | 100 | 12303 | 1-2479-01MI | Lester | 84 |
| 12072 | 1-2754-02LU | Lester | 77 | 12303394 | 2-1601-DR-2 | Delco-Remy | 48 |
| 12073 | 1-2619-01LU | Lester | 76 | 12311 | 1-2153-01MI | Lester | 84 |
| 12075 | 1-1929-01MI | Lester | 83 | 12322 | 1-2472-01HI | Lester | 67 |
| 12077 | 1-2480-01MI | Lester | 85 | 12323 | 1-2473-01HI | Lester | 67 |
| 12088 | 1-2621-01LU-2 | Lester | 76 | 12324 | 1-2474-01HI | Lester | 67 |
| 12094 | 1-2454-01MM | Lester | 76 | 12335 | 1-2358-01HI | Lester | 66 |
| 12095 | 1-2455-01MM | Lester | 73 | 12336 | 1-2496-01HI | Lester | 68 |
| 12097 | 1-2271-01HI | Lester | 65 | 12357 | 1-2823-01ND-2 | Lester | 100 |
| 121000-245 | 20-209-9 | Nippondenso | 50 | 12382 | 1-2768-01BO | Lester | 3 |
| 121000-337 | 1-1503-01ND-2 | Nippondenso | 95 | 12384 | 1-2589-01BO | Lester | 3 |
| 121000-341 | 1-1527-02ND-2 | Nippondenso | 96 | 12385 | 1-2852-01BO | Lester | 3 |
| 121000-343 | 1-1527-02ND-2 | Nippondenso | 96 | 12390 | 1-2466-01MD | Lester | 82 |
| 121000-346 | 1-1527-02ND-2 | Nippondenso | 96 | 124080-77201 | 1-2314-01HI | Yanmar | 66 |
| 121000-347 | 1-1503-05ND-2 | Nippondenso | 95 | 12422 | 1-2741-01VA | Lester | 112 |
| 121000-353 | 1-1503-06ND-2 | Nippondenso | 95 | 12425 | 1-2308-31MD | Lester | 82 |
| 121000-363 | 1-2225-01ND-2 | Nippondenso | 96 | 12428 | 1-2721-01LU | Lester | 77 |
| 121000-404 | 1-1504-01ND-2 | Nippondenso | 95 | 12490 | 1-2547-00BO | Lester | 2 |
| 121000-408 | 1-1504-05ND-2 | Nippondenso | 95 | 12491 | 1-2685-00BO | Lester | 3 |
| 121000-413 | 1-1504-06ND-2 | Nippondenso | 96 | 12530 | 1-2119-11ND | Lester | 98 |
| 121000-415 | 1-1504-05ND-2 | Nippondenso | 95 | 12558851 | 2-1796-DR | Delco-Remy | 47 |
| 121000-417 | 1-2087-01ND-2 | Nippondenso | 96 | 12560019 | 2-1690-DR-2 | Delco-Remy | 46 |
| 121000-428 | 1-2227-01ND | Nippondenso | 96 | 12560672 | 2-2054-DR-2 | Delco-Remy | 44 |
| 121000-429 | 1-2227-02ND-2 | Nippondenso | 97 | 12563176 | 2-1954-DR-2 | Delco-Remy | 44 |
| 121000-435 | 1-2227-02ND-2 | Nippondenso | 97 | 12563719 | 2-2112-DR-2 | Delco-Remy | 45 |
| 121000-445 | 1-2390-01ND | Nippondenso | 97 | 12563828 | 2-1954-DR-2 | Delco-Remy | 44 |
| 121000-447 | 1-2390-01ND | Nippondenso | 97 | 12563829 | 2-1690-DR-2 | Delco-Remy | 46 |
| 121000-448 | 1-2389-01ND-2 | Nippondenso | 97 | 12563830 | 2-1811-DR-2 | Delco-Remy | 46 |
| 121000-456 | 1-2390-01ND | Nippondenso | 97 | 12563907 | 2-2095-DR-2 | Delco-Remy | 46 |
| 12112 | 1-2315-01 | Lester | 68 | 12563908 | 2-2054-DR-2 | Delco-Remy | 44 |
| 121120-77010 | 2-2705-ND-2 | Yanmar | 109 | 12564107 | 2-2112-DR-2 | Delco-Remy | 45 |
| 12114 | 1-2471-01HI | Lester | 67 | 12564108 | 2-2143-DR-2 | Delco-Remy | 45 |
| 12115 | 1-2332-01HI | Lester | 66 | 12564110 | 2-2200-DR-2 | Delco-Remy | 45 |
| 12116 | 1-2475-01HI | Lester | 65 | 12564111 | 2-2211-DR-2 | Delco-Remy | 45 |
| 12118 | 1-2481-01HI | Lester | 67 | 12567709 | 2-2548-ND | Delco-Remy | 108 |
| 12126 | 1-2313-01HI | Lester | 66 | 12570230 | 2-1690-DR-2 | Delco-Remy | 46 |
| 12127 | 1-2316-01HI | Lester | 65 | 12570823 | 2-2143-DR-2 | Delco-Remy | 45 |
| 12129 | 1-2312-01HI | Lester | 65 | 12572715 | 2-2054-DR-2 | Delco-Remy | 44 |
| 12131 | 1-2045-01BO-2 | Lester | 2 | 12572716 | 2-2112-DR-2 | Delco-Remy | 45 |
| 12136 | 1-2062-01MI | Lester | 84 | 12573852 | 2-2200-DR-2 | Delco-Remy | 45 |
| 12138 | 1-1960-01MI | Lester | 84 | 12573853 | 2-2211-DR-2 | Delco-Remy | 45 |
| 12145 | 1-2344-00BO | Lester | 2 | 12578050 | 2-2336-DR | Delco-Remy | 44 |
| 12151 | 1-2435-01BO | Lester | 73 | 12583114 | 2-2112-DR-2 | Delco-Remy | 45 |
| 12161 | 1-2237-00BO | Lester | 2 | 12583115 | 2-2200-DR-2 | Delco-Remy | 45 |
| 12170 | 20-9900 | Lester | 49 | 12586040 | 2-2112-DR-2 | Delco-Remy | 45 |
| 12175 | 1-2308-31MD | Lester | 82 | 12592294 | 2-2336-DR | Delco-Remy | 44 |
| 12179 | 1-2476-01ND | Lester | 99 | 12592295 | 2-2200-DR-2 | Delco-Remy | 45 |
| 12180 | 1-2119-11ND | Lester | 98 | 12604477 | 2-2336-DR | Delco-Remy | 44 |
| 12180 | 1-2119-11ND-9 | Lester | 98 | 126486-77010 | 2-2318-HI | Yanmar | 72 |
| 12182 | 1-1946-01ND | Lester | 97 | 126486-77011 | 2-2318-HI | Yanmar | 72 |
| 12184 | 1-2439-01ND | Lester | 98 | 128000-002 | 2-1193-ND | Nippondenso | 101 |
| 12185 | 1-2821-01ND-2 | Lester | 99 | 128000-014 | 2-1960-ND | Nippondenso | 104 |
| 12187 | 1-2132-01ND | Lester | 98 | 128000-014 | 2-1960-ND-2 | Nippondenso | 104 |
| 12187 | 1-2132-01ND-2 | Lester | 98 | 128000-021 | 2-1526-ND | Nippondenso | 102 |
| 12189 | 1-2436-01ND | Lester | 98 | 128000-048 | 2-2045-ND | Nippondenso | 100 |
| 12190 | 1-2336-01ND | Lester | 98 | 128000-049 | 2-1745-ND-1 | Nippondenso | 103 |
| 12190 | 1-2336-01ND-9 | Lester | 98 | 128000-054 | 2-1526-ND | Nippondenso | 102 |
| 121913C91 | 50-8405 | IHC | 29 | 128000-077 | 2-2276-ND | Nippondenso | 101 |
| 121913C91 | 50-8431 | IHC | 32 | 128000-096 | 2-1193-ND | Nippondenso | 101 |
| 12198 | 1-2477-01ND | Lester | 99 | 128000-097 | 2-2784-ND-2 | Nippondenso | 111 |

CROSS REFERENCE

CROSS REFERENCE - REF# to CATALOG#

| Mfr. Part# | Catalog# | Mfr. Name | Pg. # | Mfr. Part# | Catalog# | Mfr. Name | Pg. # |
|--------------|---------------|-------------|-------|------------|-------------|-----------|-------|
| 128000-156 | 2-2265-ND | Nippondenso | 108 | 140-101 | 2-1604-DR | PIC | 48 |
| 128000-227 | 2-1526-ND | Nippondenso | 102 | 140-102 | 2-1607-DR | PIC | 48 |
| 128000-248 | 2-1526-ND | Nippondenso | 102 | 140-106 | 2-1592-DR | PIC | 47 |
| 128000-256 | 2-1751-ND-2 | Nippondenso | 103 | 140-177 | 2-1595-DR | PIC | 48 |
| 128000-288 | 2-1193-ND | Nippondenso | 101 | 140-182 | 2-1598-DR-2 | PIC | 48 |
| 128000-411 | 2-2708-ND-2 | Nippondenso | 109 | 140-376 | 2-1601-DR-2 | PIC | 48 |
| 128000-425 | 2-2234-ND | Nippondenso | 107 | 140-377 | 2-1595-DR | PIC | 48 |
| 128000-434 | 2-2710-ND-2 | Nippondenso | 101 | 140-505 | 2-1493-DR | PIC | 47 |
| 128000-468 | 2-2222-ND | Nippondenso | 106 | 140-542 | 2-1413-DR | PIC | 47 |
| 128000-491 | 2-1397-ND-1 | Nippondenso | 102 | 140-543 | 2-1796-DR | PIC | 47 |
| 128000-496 | 2-1383-ND-2 | Nippondenso | 102 | 140-560 | 2-1474-DR-2 | PIC | 46 |
| 128000-509 | 2-2709-ND-2 | Nippondenso | 110 | 140-562 | 2-1470-DR | PIC | 47 |
| 128000-527 | 2-1383-ND-2 | Nippondenso | 102 | 140-574 | 2-1912-DR-2 | PIC | 46 |
| 128000-528 | 2-1383-ND-2 | Nippondenso | 102 | 140-578 | 2-1690-DR-2 | PIC | 46 |
| 128000-530 | 2-2709-ND-2 | Nippondenso | 110 | 140-588 | 2-1811-DR-2 | PIC | 46 |
| 128000-533 | 2-2710-ND-2 | Nippondenso | 101 | 140-589 | 2-2054-DR-2 | PIC | 44 |
| 128000-567 | 2-1383-ND-2 | Nippondenso | 102 | 140-596 | 2-1954-DR-2 | PIC | 44 |
| 128000-572 | 2-2263-ND | Nippondenso | 107 | 140-596A | 2-2112-DR-2 | PIC | 45 |
| 128000-597 | 2-2279-ND | Nippondenso | 101 | 140-596B | 2-2112-DR-2 | PIC | 45 |
| 128000-628 | 2-1960-ND | Nippondenso | 104 | 140-6008 | 2-2095-DR-2 | PIC | 46 |
| 128000-628 | 2-1960-ND-2 | Nippondenso | 104 | 140-6010 | 2-2054-DR-2 | PIC | 44 |
| 128000-775 | 2-1753-ND | Nippondenso | 103 | 140-6010A | 2-2211-DR-2 | PIC | 45 |
| 128000-781 | 2-1398-ND-2 | Nippondenso | 102 | 140-6010C | 2-2336-DR | PIC | 44 |
| 128000-810 | 2-2655-ND | Nippondenso | 109 | 140-6010D | 2-2336-DR | PIC | 44 |
| 128000-846 | 2-2734-ND-2 | Nippondenso | 110 | 140-6031 | 2-2143-DR-2 | PIC | 45 |
| 128000-8460 | 2-2734-ND-2 | Nippondenso | 110 | 140-6034 | 2-2200-DR-2 | PIC | 45 |
| 128000-8462 | 2-2734-ND-2 | Nippondenso | 110 | 140-6034A | 2-2200-DR-2 | PIC | 45 |
| 128000-950 | 2-1526-ND | Nippondenso | 102 | 140-6034B | 2-2200-DR-2 | PIC | 45 |
| 128000-997 | 2-2232-ND | Nippondenso | 107 | 140-720 | 2-2753-DR-2 | PIC | 49 |
| 1294164-83 | 82-6879 | Yale | 117 | 140-720A | 2-2753-DR-2 | PIC | 49 |
| 1294164-91 | 82-6879 | Yale | 117 | 140-720B | 2-2753-DR-2 | PIC | 49 |
| 129486-77011 | 2-2318-HI | Yanmar | 72 | 140-730 | 2-2596-DR-2 | PIC | 49 |
| 129900-77010 | 2-2758-HI-2 | Yanmar | 73 | 140-730A | 2-2596-DR-2 | PIC | 49 |
| 1307454 | 1-2614-01VA | Scania | 112 | 140-831 | 50-157-9 | PIC | 28 |
| 1313394 | 50-8406-2 | Hyster | 30 | 140-860 | 50-8429 | PIC | 32 |
| 13143 | 1-2236-10ND | Lester | 97 | 140-860A | 50-8429 | PIC | 32 |
| 13301 | 1-1504-01ND-2 | Lester | 95 | 140-871 | 50-8429 | PIC | 32 |
| 13302 | 1-1504-05ND-2 | Lester | 95 | 140-871A | 50-8429 | PIC | 32 |
| 13312 | 1-1503-01ND-2 | Lester | 95 | 140-902 | 50-8424 | PIC | 31 |
| 13353 | 1-1527-02ND-2 | Lester | 96 | 140-9025 | 50-9102 | PIC | 6 |
| 13354 | 1-1503-05ND-2 | Lester | 95 | 140-903 | 50-8418 | PIC | 30 |
| 13354 | 1-1503-06ND-2 | Lester | 95 | 140-904 | 50-8432 | PIC | 32 |
| 13453 | 1-1504-06ND-2 | Lester | 96 | 140-905 | 50-8431 | PIC | 32 |
| 1347064 | 2-2099-ND | Hyster | 105 | 140-906 | 50-8423 | PIC | 31 |
| 1361853 | 1-1960-01MI | Hyster | 84 | 140-907 | 50-8419 | PIC | 31 |
| 1362069 | 2-1728-MI | Hyster | 85 | 140-908 | 50-8417 | PIC | 30 |
| 1362069 | 2-1728-MI-3 | Hyster | 92 | 140-914 | 50-8438 | PIC | 33 |
| 1363111 | 50-9108 | Iveco | 6 | 140-915 | 50-8422 | PIC | 31 |
| 1368020 | 50-9122-1 | Iveco | 7 | 140-915N | 50-8422 | PIC | 31 |
| 13742 | 1-2087-01ND-2 | Lester | 96 | 140-917 | 50-8421 | PIC | 31 |
| 13766 | 1-2227-01ND | Lester | 96 | 140-918 | 50-8434 | PIC | 33 |
| 13823 | 1-2225-01ND-2 | Lester | 96 | 140-919 | 50-8421 | PIC | 31 |
| 13824 | 1-2227-02ND-2 | Lester | 97 | 140-920 | 50-8407 | PIC | 30 |
| 1383240 | 2-2203-ND | Hyster | 106 | 140-920 | 50-8420 | PIC | 31 |
| 13843 | 1-2225-01BO | Lester | 1 | 140-920 | 50-8437 | PIC | 33 |
| 13854 | 1-2227-02BO | Lester | 1 | 140-920A | 2-2051-DR | PIC | 29 |
| 13860 | 1-2510-01BO | Lester | 2 | 140-921 | 50-8403 | PIC | 29 |
| 13860 | 1-2510-01VA | Lester | 112 | 140-922 | 2-1580-DR | PIC | 29 |
| 13874 | 1-2389-01ND-2 | Lester | 97 | 140-923 | 50-8402-2 | PIC | 29 |
| 13881 | 1-2227-01ND | Lester | 96 | 140-924 | 50-8404 | PIC | 29 |
| 13911 | 1-2390-01ND | Lester | 97 | 140-925 | 50-8405 | PIC | 29 |
| 13912 | 1-2441-01ND | Lester | 97 | 140-925 | 50-8431 | PIC | 32 |
| 13914 | 1-2541-01BO | Lester | 1 | 140-926 | 50-8406-2 | PIC | 30 |
| 13916 | 1-2526-01BO-2 | Lester | 1 | 140-927 | 50-8410 | PIC | 30 |
| 13917 | 1-2541-01BO | Lester | 1 | 140-927A | 50-8441 | PIC | 33 |
| 13920 | 1-2227-02BO | Lester | 1 | 140-930 | 50-8415 | PIC | 30 |
| 13985 | 1-2553-01BO | Lester | 1 | 140-931 | 50-8426 | PIC | 32 |
| 13987 | 1-2877-01BO | Lester | 1 | 140-932 | 50-8420 | PIC | 31 |
| 140-013 | 2-2286-DR | PIC | 43 | 140-933 | 50-8429 | PIC | 32 |
| 140-014 | 2-2287-DR | PIC | 44 | 140-934 | 50-8425 | PIC | 32 |
| 140-0265 | 2-2748-DR-2 | PIC | 28 | 140-935 | 50-8428 | PIC | 32 |
| 140-100 | 2-1593-DR | PIC | 48 | 140-936 | 50-8436 | PIC | 33 |

CROSS REFERENCE

CROSS REFERENCE - REF# to CATALOG#

| Mfr. Part No. | Catalog No. | Mfr. Name | Pg. # | Mfr. Part No. | Catalog No. | Mfr. Name | Pg. # |
|---------------|-------------|-----------|-------|---------------|-------------|-----------|-------|
| 140-937 | 50-8437 | PIC | 33 | 141-701A | 2-2350-DR | PIC | 39 |
| 140-938 | 50-8433 | PIC | 33 | 141-701A | 2-2350-DR-2 | PIC | 38 |
| 140-946 | 2-2770-NK | PIC | 94 | 141-703 | 2-2347-DR-1 | PIC | 38 |
| 141-203 | 50-159-1 | PIC | 36 | 141-703 | 2-2352-DR-1 | PIC | 39 |
| 141-204 | 50-159-1 | PIC | 36 | 141-703A | 2-2347-DR-1 | PIC | 38 |
| 141-205 | 50-159-1 | PIC | 36 | 141-703B | 2-2366-DR | PIC | 39 |
| 141-209 | 50-159-1 | PIC | 36 | 141-705 | 2-2345-DR-1 | PIC | 38 |
| 141-211 | 50-159-1 | PIC | 36 | 141-709 | 2-2348-DR | PIC | 38 |
| 141-213 | 50-159-1 | PIC | 36 | 141-709A | 2-2348-DR | PIC | 38 |
| 141-281 | 50-159-1 | PIC | 36 | 141-713 | 2-2349-DR | PIC | 38 |
| 141-300 | 50-113-1 | PIC | 35 | 141-713 | 2-2349-DR-1 | PIC | 38 |
| 141-300A | 50-113-1 | PIC | 35 | 141-713A | 2-2349-DR | PIC | 38 |
| 141-300B | 50-113-1 | PIC | 35 | 141-713A | 2-2349-DR-1 | PIC | 38 |
| 141-300E | 50-113-1 | PIC | 35 | 141-715 | 2-2364-DR | PIC | 39 |
| 141-300F | 50-113-1 | PIC | 35 | 141-719 | 2-2353-DR-1 | PIC | 39 |
| 141-301 | 50-193-1 | PIC | 36 | 141-720 | 2-2367-DR | PIC | 39 |
| 141-301A | 50-193-1 | PIC | 36 | 142-043 | 50-103-1 | PIC | 41 |
| 141-303 | 50-193-1 | PIC | 36 | 142-043 | 50-103-2 | PIC | 40 |
| 141-303A | 50-193-1 | PIC | 36 | 142-043B | 50-103-1 | PIC | 41 |
| 141-306 | 50-194-1 | PIC | 37 | 142-043B | 50-103-2 | PIC | 40 |
| 141-306A | 50-194-1 | PIC | 37 | 142-101 | 50-108-1 | PIC | 41 |
| 141-310 | 50-158-1 | PIC | 36 | 142-101 | 50-108-2 | PIC | 41 |
| 141-310A | 50-158-1 | PIC | 36 | 142-101B | 50-108-1 | PIC | 41 |
| 141-310B | 50-158-1 | PIC | 36 | 142-101B | 50-108-2 | PIC | 41 |
| 141-310D | 50-158-1 | PIC | 36 | 142-101D | 50-108-1 | PIC | 41 |
| 141-312 | 50-162-1 | PIC | 36 | 142-101D | 50-108-2 | PIC | 41 |
| 141-312A | 50-162-1 | PIC | 36 | 142-101F | 50-108-1 | PIC | 41 |
| 141-312C | 2-1584-DR-2 | PIC | 34 | 142-101F | 50-108-2 | PIC | 41 |
| 141-312D | 2-1584-DR-2 | PIC | 34 | 142-101H | 50-108-1 | PIC | 41 |
| 141-313 | 50-162-1 | PIC | 36 | 142-101H | 50-108-2 | PIC | 41 |
| 141-313A | 50-162-1 | PIC | 36 | 142-101I | 50-108-1 | PIC | 41 |
| 141-313C | 50-162-1 | PIC | 36 | 142-101I | 50-108-2 | PIC | 41 |
| 141-313D | 50-162-1 | PIC | 36 | 142-102 | 50-108-1 | PIC | 41 |
| 141-314 | 2-1584-DR-2 | PIC | 34 | 142-102 | 50-108-2 | PIC | 41 |
| 141-325 | 2-1582-DR-1 | PIC | 34 | 142-102B | 50-108-1 | PIC | 41 |
| 141-327 | 2-2206-DR-1 | PIC | 35 | 142-102B | 50-108-2 | PIC | 41 |
| 141-330 | 50-160-1 | PIC | 36 | 142-102D | 50-108-1 | PIC | 41 |
| 141-330B | 50-160-1 | PIC | 36 | 142-102D | 50-108-2 | PIC | 41 |
| 141-330D | 50-160-1 | PIC | 36 | 142-102F | 50-108-1 | PIC | 41 |
| 141-330F | 50-160-1 | PIC | 36 | 142-102F | 50-108-2 | PIC | 41 |
| 141-331 | 50-160-1 | PIC | 36 | 142-102H | 50-108-1 | PIC | 41 |
| 141-331A | 50-160-1 | PIC | 36 | 142-102H | 50-108-2 | PIC | 41 |
| 141-331C | 50-160-1 | PIC | 36 | 142-102I | 50-108-1 | PIC | 41 |
| 141-331D | 50-160-1 | PIC | 36 | 142-102I | 50-108-2 | PIC | 41 |
| 141-350 | 50-159-1 | PIC | 36 | 142-108 | 2-2899-DR | PIC | 40 |
| 141-350A | 50-159-1 | PIC | 36 | 142-108B | 2-2899-DR | PIC | 40 |
| 141-350D | 50-161-1 | PIC | 36 | 142-108F | 2-2899-DR | PIC | 40 |
| 141-350E | 50-161-1 | PIC | 36 | 142-109 | 2-2899-DR | PIC | 40 |
| 141-351 | 50-159-1 | PIC | 36 | 142-109D | 2-2899-DR | PIC | 40 |
| 141-351A | 50-159-1 | PIC | 36 | 142-109F | 2-2899-DR | PIC | 40 |
| 141-351B | 50-159-1 | PIC | 36 | 142-110 | 50-108-1 | PIC | 41 |
| 141-351D | 50-161-1 | PIC | 36 | 142-110 | 50-108-2 | PIC | 41 |
| 141-351E | 50-161-1 | PIC | 36 | 142-111 | 50-108-1 | PIC | 41 |
| 141-353 | 2-2207-DR-1 | PIC | 35 | 142-111 | 50-108-2 | PIC | 41 |
| 141-361 | 50-161-1 | PIC | 36 | 142-115 | 50-108-1 | PIC | 41 |
| 141-372 | 2-2472-DR | PIC | 41 | 142-115 | 50-108-2 | PIC | 41 |
| 141-395 | 2-2470-DR | PIC | 35 | 142-115D | 50-108-1 | PIC | 41 |
| 141-450 | 2-2357-DR-1 | PIC | 34 | 142-115D | 50-108-2 | PIC | 41 |
| 141-451 | 2-2704-DR-2 | PIC | 34 | 142-116 | 50-108-1 | PIC | 41 |
| 141-455 | 2-2389-DR | PIC | 34 | 142-116 | 50-108-2 | PIC | 41 |
| 141-460 | 2-2391-DR | PIC | 34 | 142-121 | 50-100-1 | PIC | 40 |
| 141-470 | 2-2377-DR | PIC | 37 | 142-121 | 50-100-2 | PIC | 40 |
| 141-470 | 2-2377-DR-1 | PIC | 37 | 142-121 | 50-193-1 | PIC | 36 |
| 141-472 | 2-2372-DR | PIC | 37 | 142-121B | 50-100-1 | PIC | 40 |
| 141-475 | 2-2379-DR | PIC | 37 | 142-121B | 50-100-2 | PIC | 40 |
| 141-476 | 2-2375-DR | PIC | 37 | 142-121B | 50-108-1 | PIC | 41 |
| 141-476 | 2-2375-DR-1 | PIC | 37 | 142-121B | 50-108-2 | PIC | 41 |
| 141-700 | 2-2001-DR | PIC | 37 | 142-121D | 50-100-1 | PIC | 40 |
| 141-700 | 2-2350-DR | PIC | 39 | 142-121D | 50-100-2 | PIC | 40 |
| 141-700 | 2-2350-DR-2 | PIC | 38 | 142-121F | 50-100-1 | PIC | 40 |
| 141-701 | 2-2350-DR | PIC | 39 | 142-121F | 50-100-2 | PIC | 40 |
| 141-701 | 2-2350-DR-2 | PIC | 38 | 142-122 | 50-100-1 | PIC | 40 |

CROSS REFERENCE

CROSS REFERENCE - REF# to CATALOG#

| Mfr. Part# | Catalog# | Mfr. Name | Pg. # | Mfr. Part# | Catalog# | Mfr. Name | Pg. # |
|------------|------------|-----------|-------|------------|--------------|------------------|-------|
| 142-122 | .50-100-2 | .PIC | .40 | 142-192 | .2-2474-DR | .PIC | .43 |
| 142-122 | .50-193-1 | .PIC | .36 | 142-194 | .50-111 | .PIC | .43 |
| 142-122B | .50-100-1 | .PIC | .40 | 142-194 | .50-111-1 | .PIC | .43 |
| 142-122B | .50-100-2 | .PIC | .40 | 142-211 | .50-153-1 | .PIC | .43 |
| 142-131 | .50-100-1 | .PIC | .40 | 142-211 | .50-153-2 | .PIC | .43 |
| 142-131 | .50-100-2 | .PIC | .40 | 142-211H | .50-192-1 | .PIC | .43 |
| 142-131B | .50-100-1 | .PIC | .40 | 142-211H | .50-192-2 | .PIC | .43 |
| 142-131B | .50-100-2 | .PIC | .40 | 142-212 | .50-153-1 | .PIC | .43 |
| 142-132 | .50-100-1 | .PIC | .40 | 142-212 | .50-153-2 | .PIC | .43 |
| 142-132 | .50-100-2 | .PIC | .40 | 142-212H | .50-192-1 | .PIC | .43 |
| 142-132B | .50-100-1 | .PIC | .40 | 142-212H | .50-192-2 | .PIC | .43 |
| 142-132B | .50-100-2 | .PIC | .40 | 142-218 | .50-153-1 | .PIC | .43 |
| 142-132F | .50-100-1 | .PIC | .40 | 142-218 | .50-153-2 | .PIC | .43 |
| 142-132F | .50-100-2 | .PIC | .40 | 142-221 | .50-150-1 | .PIC | .42 |
| 142-141 | .50-104-1 | .PIC | .41 | 142-221 | .50-150-2 | .PIC | .42 |
| 142-141 | .50-104-2 | .PIC | .41 | 142-222 | .50-150-1 | .PIC | .42 |
| 142-141B | .50-104-1 | .PIC | .41 | 142-222 | .50-150-2 | .PIC | .42 |
| 142-141B | .50-104-2 | .PIC | .41 | 142-222D | .50-150-1 | .PIC | .42 |
| 142-141C | .50-108-1 | .PIC | .41 | 142-222D | .50-150-2 | .PIC | .42 |
| 142-141C | .50-108-2 | .PIC | .41 | 142-222F | .50-150-1 | .PIC | .42 |
| 142-142 | .50-104-1 | .PIC | .41 | 142-222F | .50-150-2 | .PIC | .42 |
| 142-142 | .50-104-2 | .PIC | .41 | 142-225 | .50-150-1 | .PIC | .42 |
| 142-142B | .50-104-1 | .PIC | .41 | 142-225 | .50-150-2 | .PIC | .42 |
| 142-142B | .50-104-2 | .PIC | .41 | 142-226 | .50-150-1 | .PIC | .42 |
| 142-142C | .50-104-1 | .PIC | .41 | 142-226 | .50-150-2 | .PIC | .42 |
| 142-142C | .50-104-2 | .PIC | .41 | 142-226D | .50-150-1 | .PIC | .42 |
| 142-144 | .50-104-1 | .PIC | .41 | 142-226D | .50-150-2 | .PIC | .42 |
| 142-144 | .50-104-2 | .PIC | .41 | 142-241 | .50-151-1 | .PIC | .42 |
| 142-145 | .50-104-1 | .PIC | .41 | 142-241 | .50-151-2 | .PIC | .42 |
| 142-145 | .50-104-2 | .PIC | .41 | 142-241 | .50-151-3 | .PIC | .42 |
| 142-151 | .50-104-1 | .PIC | .41 | 142-241A | .50-151-1 | .PIC | .42 |
| 142-151 | .50-104-2 | .PIC | .41 | 142-241A | .50-151-2 | .PIC | .42 |
| 142-151B | .50-104-1 | .PIC | .41 | 142-241A | .50-151-3 | .PIC | .42 |
| 142-151B | .50-104-2 | .PIC | .41 | 142-242 | .50-151-1 | .PIC | .42 |
| 142-152 | .50-103-1 | .PIC | .41 | 142-242 | .50-151-2 | .PIC | .42 |
| 142-152 | .50-103-2 | .PIC | .40 | 142-242 | .50-151-3 | .PIC | .42 |
| 142-152A | .50-103-1 | .PIC | .41 | 142-242H | .50-151-3 | .PIC | .42 |
| 142-152A | .50-103-2 | .PIC | .40 | 142-253 | .2-2675-DR | .PIC | .42 |
| 142-161 | .50-103-1 | .PIC | .41 | 142-258 | .50-152-1 | .PIC | .42 |
| 142-161 | .50-103-2 | .PIC | .40 | 142-258 | .50-152-2 | .PIC | .42 |
| 142-161B | .50-103-1 | .PIC | .41 | 142-261 | .50-152-1 | .PIC | .42 |
| 142-161B | .50-103-2 | .PIC | .40 | 142-261 | .50-152-2 | .PIC | .42 |
| 142-162 | .50-103-1 | .PIC | .41 | 142-261F | .50-152-1 | .PIC | .42 |
| 142-162 | .50-103-2 | .PIC | .40 | 142-261F | .50-152-2 | .PIC | .42 |
| 142-162B | .50-103-1 | .PIC | .41 | 142-262F | .50-103-1 | .PIC | .41 |
| 142-162B | .50-103-2 | .PIC | .40 | 142-262F | .50-103-2 | .PIC | .40 |
| 142-164 | .50-160-1 | .PIC | .36 | 142-264 | .2-2471-DR | .PIC | .41 |
| 142-171 | .50-103-1 | .PIC | .41 | 142-264A | .2-2471-DR | .PIC | .41 |
| 142-171 | .50-103-2 | .PIC | .40 | 142-264H | .2-2471-DR | .PIC | .41 |
| 142-171B | .50-103-1 | .PIC | .41 | 142-264I | .2-2471-DR | .PIC | .41 |
| 142-171B | .50-103-2 | .PIC | .40 | 142-295 | .50-150-1 | .PIC | .42 |
| 142-172 | .50-103-1 | .PIC | .41 | 142-295 | .50-150-2 | .PIC | .42 |
| 142-172 | .50-103-2 | .PIC | .40 | 142-295D | .50-150-1 | .PIC | .42 |
| 142-172B | .50-103-1 | .PIC | .41 | 142-295D | .50-150-2 | .PIC | .42 |
| 142-172B | .50-103-2 | .PIC | .40 | 14231 | .1-1112-01 | .Lester | .65 |
| 142-172J | .50-103-1 | .PIC | .41 | 142-326 | .50-150-1 | .PIC | .42 |
| 142-172J | .50-103-2 | .PIC | .40 | 142-326 | .50-150-2 | .PIC | .42 |
| 142-173 | .50-103-1 | .PIC | .41 | 142-332 | .50-150-1 | .PIC | .42 |
| 142-173 | .50-103-2 | .PIC | .40 | 142-332 | .50-150-2 | .PIC | .42 |
| 142-173B | .50-103-1 | .PIC | .41 | 142-364 | .50-150-1 | .PIC | .42 |
| 142-173B | .50-103-2 | .PIC | .40 | 142-364 | .50-150-2 | .PIC | .42 |
| 142-177 | .50-103-1 | .PIC | .41 | 142-368 | .2-2703-DR | .PIC | .42 |
| 142-177 | .50-103-2 | .PIC | .40 | 142-612 | .50-108-1 | .PIC | .41 |
| 142-180 | .50-111 | .PIC | .43 | 142-612 | .50-108-2 | .PIC | .41 |
| 142-180 | .50-111-1 | .PIC | .43 | 142-612A | .50-108-1 | .PIC | .41 |
| 142-183 | .2-2473-DR | .PIC | .43 | 142-612A | .50-108-2 | .PIC | .41 |
| 142-183A | .2-2473-DR | .PIC | .43 | 142-612B | .50-108-1 | .PIC | .41 |
| 142-183D | .2-2473-DR | .PIC | .43 | 142-612B | .50-108-2 | .PIC | .41 |
| 142-186 | .50-111 | .PIC | .43 | 142-627 | .50-103-1 | .PIC | .41 |
| 142-186 | .50-111-1 | .PIC | .43 | 142-627 | .50-103-2 | .PIC | .40 |
| 142-187 | .50-111 | .PIC | .43 | 1447110R91 | .1-2619-01LU | .Massey Ferguson | .76 |
| 142-187 | .50-111-1 | .PIC | .43 | 1450928 | .1-1960-01MI | .Hyster | .84 |

CROSS REFERENCE

CROSS REFERENCE - REF# to CATALOG#

| Mfr. Part No. | Catalog No. | Mfr. Name | Pg. # | Mfr. Part No. | Catalog No. | Mfr. Name | Pg. # |
|---------------|-------------|------------------|-------|---------------|---------------|----------------|-------|
| 14519 | 1-2461-01ND | Lester | .94 | 15754097 | 1-2419-21DR | Delco-Remy | .22 |
| 14534 | 1-1111-02HI | Lester | .64 | 15754097A | 1-2419-21DR | Delco-Remy | .22 |
| 146444C91 | 20-104-1 | IHC | .10 | 15755616 | 1-2320-21DR | Delco-Remy | .21 |
| 146447C91 | 20-104-1 | IHC | .10 | 15755900 | 1-2510-01BO | Delco-Remy | .2 |
| 146448C92 | 20-104-1 | IHC | .10 | 15755900 | 1-2510-01VA | Delco-Remy | .112 |
| 14687 | 1-2391-01MI | Lester | .83 | 15757624 | 1-1995-21DR-1 | Delco-Remy | .26 |
| 14735 | 1-1940-01HI | Lester | .65 | 15760058 | 1-2398-11DR | Delco-Remy | .27 |
| 1500023-01 | 2-1727-MI | Yale | .85 | 15768829 | 1-2320-21DR | Delco-Remy | .21 |
| 1500023-05 | 2-1728-MI | Yale | .85 | 15768830 | 1-2419-21DR | Delco-Remy | .22 |
| 1500023-05 | 2-1728-MI-3 | Yale | .92 | 15769252 | 1-2415-41DR | Delco-Remy | .22 |
| 1500225-14 | 2-2024-MI | Yale | .89 | 15769253 | 1-2418-41DR | Delco-Remy | .22 |
| 150-025 | 2-2288-FD | PIC | .61 | 15829 | 82-6882 | Meyer Products | .120 |
| 150-028 | 2-2289-FD | PIC | .61 | 15831639 | 1-2602-01VA | Delco-Remy | .112 |
| 150-124 | 2-1668-FD | PIC | .60 | 15841 | 82-6882 | Meyer Products | .120 |
| 150-131 | 2-1674-FD | PIC | .60 | 15881-64200 | 1-2436-01ND | Kubota | .98 |
| 150-131A | 2-1674-FD | PIC | .60 | 15881-64201 | 1-2436-01ND | Kubota | .98 |
| 150-152 | 2-1675-FD | PIC | .61 | 160-124 | 82-6852 | PIC | .119 |
| 150-180 | 2-1648-FD | PIC | .60 | 160-124 | 82-6852-1 | PIC | .119 |
| 150-185 | 2-1642-FD | PIC | .60 | 160-124 | 82-6889 | PIC | .120 |
| 150-185A | 2-1642-FD | PIC | .60 | 160-164 | 82-7850 | PIC | .120 |
| 150-186 | 2-1648-FD | PIC | .60 | 160-164A | 82-7850 | PIC | .120 |
| 150-188 | 2-1649-FD | PIC | .60 | 160-183 | 82-6869 | PIC | .115 |
| 15027 | 3-1005-01LU | Lester | .77 | 160-183 | 82-6869-1 | PIC | .115 |
| 150-311 | 2-1894-FD-1 | PIC | .63 | 160-183 | 82-6874 | PIC | .116 |
| 150-311A | 2-1894-FD-1 | PIC | .63 | 160-299 | 82-6888 | PIC | .117 |
| 150-312 | 2-1806-FD-1 | PIC | .62 | 160-435 | 82-6888 | PIC | .117 |
| 150-312A | 2-1806-FD-1 | PIC | .62 | 160-653 | 82-6868-1 | PIC | .121 |
| 150-312B | 2-1806-FD-1 | PIC | .62 | 160-653 | 82-6868-2 | PIC | .122 |
| 150-314A | 2-1887-FD-1 | PIC | .63 | 160-653 | 82-6868-3 | PIC | .122 |
| 150-316 | 50-220-1 | PIC | .64 | 160-653 | 82-6884 | PIC | .122 |
| 150-316A | 2-1895-FD-1 | PIC | .63 | 160-654 | 82-6868-1 | PIC | .121 |
| 150-317 | 2-1885-FD-1 | PIC | .62 | 160-654 | 82-6868-2 | PIC | .122 |
| 150-317A | 2-1885-FD-1 | PIC | .62 | 160-654 | 82-6868-3 | PIC | .122 |
| 150-319 | 2-1881-FD-1 | PIC | .62 | 160-654 | 82-6884 | PIC | .122 |
| 150-319A | 2-1881-FD-1 | PIC | .62 | 160-705 | 82-6861 | PIC | .114 |
| 150-321 | 2-1799-FD-1 | PIC | .62 | 160-706 | 82-6861 | PIC | .114 |
| 150-321A | 2-1799-FD-1 | PIC | .62 | 160-707 | 82-6862 | PIC | .115 |
| 150-321B | 2-1799-FD-1 | PIC | .62 | 160-708 | 82-6862 | PIC | .115 |
| 150-321C | 2-1799-FD-1 | PIC | .62 | 160-716 | 82-6855 | PIC | .113 |
| 150-321D | 2-1799-FD-1 | PIC | .62 | 160-716 | 82-6871-1 | PIC | .116 |
| 150-322 | 2-1882-FD-1 | PIC | .62 | 160-716A | 82-6855 | PIC | .113 |
| 150-322A | 2-1882-FD-1 | PIC | .62 | 160-716A | 82-6871-1 | PIC | .116 |
| 150-323 | 2-1956-FD-1 | PIC | .64 | 160-718 | 82-6870 | PIC | .116 |
| 150-323A | 2-1956-FD-1 | PIC | .64 | 160-718A | 82-6870 | PIC | .116 |
| 150-324 | 2-1953-FD-1 | PIC | .63 | 160-735 | 82-7850 | PIC | .120 |
| 150-324A | 2-1953-FD-1 | PIC | .63 | 160-798 | 82-6866 | PIC | .121 |
| 150-325 | 2-1883-FD-1 | PIC | .62 | 160-799 | 82-6865 | PIC | .121 |
| 150-325A | 2-1883-FD-1 | PIC | .62 | 160-800 | 82-6867 | PIC | .121 |
| 150-333 | 50-237-1 | PIC | .64 | 160-800 | 82-6867-1 | PIC | .121 |
| 150-333A | 2-1886-FD-1 | PIC | .63 | 160-801 | 82-6890 | PIC | .122 |
| 150-338 | 2-1910-FD-1 | PIC | .63 | 160-802 | 82-6868-1 | PIC | .121 |
| 150-339 | 2-1955-FD-1 | PIC | .64 | 160-802 | 82-6868-2 | PIC | .122 |
| 150-349 | 2-2218-FD | PIC | .64 | 160-802 | 82-6868-3 | PIC | .122 |
| 150-350 | 2-2197-FD-2 | PIC | .61 | 160-802 | 82-6884 | PIC | .122 |
| 150-350A | 2-2197-FD-2 | PIC | .61 | 160-806 | 82-6867 | PIC | .121 |
| 150-351 | 2-2215-FD | PIC | .61 | 160-806 | 82-6867-1 | PIC | .121 |
| 15052338 | 2-1912-DR-2 | Delco-Remy | .46 | 160-807 | 82-6880 | PIC | .117 |
| 15054 | 82-7850 | Meyer Products | .120 | 160-807A | 82-6880 | PIC | .117 |
| 15087023 | 1-2415-41DR | Delco-Remy | .22 | 160-807B | 82-6880 | PIC | .117 |
| 151-21044 | 82-6879 | Webster Electric | .117 | 160-808 | 82-6862 | PIC | .115 |
| 1519632 | 2-2099-ND | Hyster | .105 | 160-808A | 82-6862 | PIC | .115 |
| 15200109 | 1-2556-21DR | Delco-Remy | .28 | 160-808B | 82-6862 | PIC | .115 |
| 15204278 | 1-2878-01BO | Delco-Remy | .3 | 160-809 | 82-6855 | PIC | .113 |
| 154011053 | 2-2285-BO | Iveco | .4 | 160-809 | 82-6871-1 | PIC | .116 |
| 15461-63013 | 2-2107-ND | Kubota | .105 | 160-809B | 82-6855 | PIC | .113 |
| 15461-63015 | 2-2107-ND | Kubota | .105 | 160-809B | 82-6871-1 | PIC | .116 |
| 15621-63013 | 2-2660-ND | Kubota | .109 | 160-811 | 82-6885 | PIC | .117 |
| 15621-63014 | 2-2660-ND | Kubota | .109 | 160-811 | 82-7851 | PIC | .118 |
| 15621-63015 | 2-2660-ND | Kubota | .109 | 160-815 | 82-6888 | PIC | .117 |
| 15689 | 82-7852 | Meyer Products | .120 | 160-815A | 82-6888 | PIC | .117 |
| 15727 | 82-7852 | Meyer Products | .120 | 160-818 | 82-6860 | PIC | .114 |
| 15750871 | 1-2419-21DR | Delco-Remy | .22 | 160-818 | 82-6860-1 | PIC | .114 |

CROSS REFERENCE

CROSS REFERENCE - REF# to CATALOG#

| Mfr. Part# | Catalog# | Mfr. Name | Pg. # | Mfr. Part# | Catalog# | Mfr. Name | Pg. # |
|-------------|----------------|------------------|-------|-------------|--------------|-------------------|-------|
| 160-818 | .82-6860-2 | .PIC | .114 | 16635 | .2-2276-ND | .Lester | .101 |
| 160-818 | .82-6860-3 | .PIC | .114 | 16635 | .50-159-1 | .Lester | .36 |
| 160-826 | .82-6885 | .PIC | .117 | 16641 | .2-2277-ND | .Lester | .101 |
| 160-826 | .82-7851 | .PIC | .118 | 16644 | .2-2044-ND | .Lester | .100 |
| 160-830 | .82-6875 | .PIC | .118 | 1664631C91 | .20-501-1 | .IHC | .73 |
| 160-833A | .82-6868-1 | .PIC | .121 | 1664632C91 | .20-501-1 | .IHC | .73 |
| 160-833A | .82-6868-2 | .PIC | .122 | 1664633C9 | .20-501-1 | .IHC | .73 |
| 160-833A | .82-6868-3 | .PIC | .122 | 1664634C91 | .20-504-1 | .IHC | .74 |
| 160-833A | .82-6884 | .PIC | .122 | 16655 | .2-1962-ND | .Lester | .100 |
| 160-834 | .82-6861 | .PIC | .114 | 16657 | .2-2705-ND-2 | .Lester | .109 |
| 160-834A | .82-6861 | .PIC | .114 | 16658 | .2-1726-ND-2 | .Lester | .102 |
| 160-835 | .82-6860 | .PIC | .114 | 16660 | .50-9202 | .Lester | .79 |
| 160-835 | .82-6860-1 | .PIC | .114 | 16669 | .2-2282-LU | .Lester | .80 |
| 160-835 | .82-6860-2 | .PIC | .114 | 16670 | .2-2290-LU | .Lester | .80 |
| 160-835 | .82-6860-3 | .PIC | .114 | 16705-64011 | .1-2477-01ND | .Kubota | .99 |
| 160-836 | .82-6886 | .PIC | .119 | 16705-64012 | .1-2477-01ND | .Kubota | .99 |
| 160-841 | .82-6852 | .PIC | .119 | 16739 | .2-1193-ND | .Lester | .101 |
| 160-841 | .82-6852-1 | .PIC | .119 | 16793 | .2-1727-MI | .Lester | .85 |
| 160-841 | .82-6889 | .PIC | .120 | 16794 | .2-1740-MI | .Lester | .86 |
| 160-842 | .82-6885 | .PIC | .117 | 16795 | .2-1728-MI | .Lester | .85 |
| 160-842 | .82-7851 | .PIC | .118 | 16795 | .2-2706-MI | .Lester | .86 |
| 160-843 | .82-6854 | .PIC | .113 | 16796 | .2-1729-MI | .Lester | .85 |
| 160-843 | .82-6854-1 | .PIC | .113 | 16798 | .2-2088-MI | .Lester | .86 |
| 160-843A | .82-6854 | .PIC | .113 | 1680064-M1 | .2-2305-LU | .Massey Ferguson | .79 |
| 160-843A | .82-6854-1 | .PIC | .113 | 16873 | .2-2220-MI | .Lester | .90 |
| 160-843A | .82-6873 | .PIC | .116 | 16881 | .2-1745-ND-1 | .Lester | .103 |
| 160-843B | .82-6854 | .PIC | .113 | 16896 | .2-2106-ND | .Lester | .105 |
| 160-843B | .82-6854-1 | .PIC | .113 | 16924 | .2-1728-MI | .Lester | .85 |
| 160-843B | .82-6873 | .PIC | .116 | 16924 | .2-1728-MI-3 | .Lester | .92 |
| 160-844 | .82-6859 | .PIC | .114 | 16935 | .2-1733-MI | .Lester | .88 |
| 160-848 | .82-7852 | .PIC | .120 | 16984 | .2-2303-LU | .Lester | .80 |
| 160-868 | .82-7861 | .PIC | .118 | 16990 | .2-1526-ND | .Lester | .102 |
| 160-877 | .82-6853 | .PIC | .120 | 17008 | .2-1732-MI-1 | .Lester | .88 |
| 160-893 | .82-6862 | .PIC | .115 | 170-272A | .50-8407 | .PIC | .30 |
| 160-903 | .82-6861 | .PIC | .114 | 17037 | .2-1254-MI-2 | .Lester | .87 |
| 160-903A | .82-6861 | .PIC | .114 | 17071 | .2-2304-LU | .Lester | .81 |
| 160-903B | .82-6861 | .PIC | .114 | 17071 | .2-2304-LU-1 | .Lester | .81 |
| 160-903C | .82-6861 | .PIC | .114 | 17072 | .2-2281-LU | .Lester | .79 |
| 160-905 | .82-6876 | .PIC | .118 | 17072 | .2-2281-LU-1 | .Lester | .79 |
| 160-909 | .82-6864 | .PIC | .115 | 17073 | .50-9110-1 | .Lester | .7 |
| 160-9129 | .82-6879 | .PIC | .117 | 17074 | .50-9109-1 | .Lester | .6 |
| 160-916 | .82-6875 | .PIC | .118 | 17074 | .50-9124-1 | .Lester | .7 |
| 160-917 | .82-6860 | .PIC | .114 | 17075 | .50-9124-1 | .Lester | .7 |
| 160-917 | .82-6860-1 | .PIC | .114 | 17077 | .2-2707-BO-2 | .Lester | .5 |
| 160-917 | .82-6860-2 | .PIC | .114 | 17079 | .2-2311-HI | .Lester | .72 |
| 160-917 | .82-6860-3 | .PIC | .114 | 17081 | .2-1963-MI | .Lester | .89 |
| 160-9245 | .82-6862 | .PIC | .115 | 17084 | .2-1383-ND-2 | .Lester | .102 |
| 160-9259 | .82-6879 | .PIC | .117 | 17086 | .2-2294-VA | .Lester | .112 |
| 160-993 | .82-6858 | .PIC | .121 | 17088 | .2-1734-HI | .Lester | .70 |
| 160-995 | .82-6887 | .PIC | .117 | 17089 | .2-1734-HI | .Lester | .70 |
| 1618-05-M3 | .2-2282-LU | .Massey Ferguson | .80 | 17092 | .50-9105-1 | .Lester | .6 |
| 1618318C91 | .20-504-1 | .IHC | .74 | 17093 | .2-2325-BO | .Lester | .5 |
| 16201 | .2-1741-1 | .Lester | .86 | 17094 | .50-9115 | .Lester | .7 |
| 16207 | .2-1724-HI-1 | .Lester | .68 | 17095 | .2-1803-BO-2 | .Lester | .4 |
| 16210 | .2-1741-1 | .Lester | .86 | 17096 | .2-1781-MI | .Lester | .88 |
| 16223 | .2-1682-ND | .Lester | .100 | 17100 | .2-1737-ND | .Lester | .103 |
| 16231-24011 | .1-2476-01ND | .Kubota | .99 | 17106 | .50-9100-1 | .Lester | .5 |
| 16231-64010 | .1-2336-01ND-9 | .Kubota | .98 | 17110 | .2-1612-MI | .Lester | .88 |
| 16231-64011 | .1-2336-01ND | .Kubota | .98 | 17110 | .2-1612-MI-2 | .Lester | .88 |
| 16231-64011 | .1-2336-01ND-9 | .Kubota | .98 | 17111 | .50-9101-1 | .Lester | .6 |
| 16231-64012 | .1-2336-01ND | .Kubota | .98 | 17112 | .50-9107 | .Lester | .6 |
| 16231-64012 | .1-2336-01ND-9 | .Kubota | .98 | 17116 | .2-1960-ND | .Lester | .104 |
| 16235-63010 | .2-2656-ND | .Kubota | .109 | 17116 | .2-1960-ND-2 | .Lester | .104 |
| 16235-63011 | .2-2656-ND | .Kubota | .109 | 171-21044 | .82-6879 | .Webster Electric | .117 |
| 16235-63012 | .2-2656-ND | .Kubota | .109 | 17126 | .2-2325-BO | .Lester | .5 |
| 16241-64010 | .1-2476-01ND | .Kubota | .99 | 17176 | .2-1996-MI | .Lester | .92 |
| 16241-64011 | .1-2476-01ND | .Kubota | .99 | 17184 | .50-9900 | .Lester | .49 |
| 16241-64012 | .1-2476-01ND | .Kubota | .99 | 17215 | .2-1397-ND-1 | .Lester | .102 |
| 16608 | .50-9200 | .Lester | .82 | 17219 | .50-9900 | .Lester | .49 |
| 16608 | .50-9200-1 | .Lester | .82 | 17244 | .2-1780-MI | .Lester | .88 |
| 16608 | .50-9200-2 | .Lester | .82 | 17244 | .2-2227-MI | .Lester | .91 |
| 16614 | .2-1754-ND | .Lester | .103 | 17244 | .2-2227-MI-2 | .Lester | .91 |

CROSS REFERENCE

CROSS REFERENCE - REF# to CATALOG#

| Mfr. Part No. | Catalog No. | Mfr. Name | Pg. # | Mfr. Part No. | Catalog No. | Mfr. Name | Pg. # |
|---------------|-------------|--------------|-------|---------------|-------------|-----------|-------|
| 17290 | 2-2708-ND-2 | Lester | 109 | 17933 | 2-2697-MI | Lester | 93 |
| 17291 | 2-1554-MI | Lester | 85 | 18008 | 2-2043-ND | Lester | 100 |
| 17291 | 2-1554-MI-1 | Lester | 85 | 18018 | 2-2726-ND-2 | Lester | 110 |
| 17292 | 2-2709-ND-2 | Lester | 110 | 18027 | 50-9124-1 | Lester | 7 |
| 17294 | 2-2026-HI | Lester | 69 | 18029 | 50-9101-1 | Lester | 6 |
| 17298-63010 | 2-2107-ND | Kubota | 105 | 18030 | 2-2283-BO | Lester | 4 |
| 17298-63011 | 2-2107-ND | Kubota | 105 | 180-300 | 50-9200 | PIC | 82 |
| 17298-63013 | 2-2107-ND | Kubota | 105 | 180-300 | 50-9200-1 | PIC | 82 |
| 17300 | 2-2007-HI | Lester | 69 | 180-300 | 50-9200-2 | PIC | 82 |
| 17302 | 2-1753-ND | Lester | 103 | 180-300D | 50-9200-2 | PIC | 82 |
| 17309 | 2-2669-BO | Lester | 5 | 180-301 | 50-9200-2 | PIC | 82 |
| 17311 | 2-2784-ND-2 | Lester | 111 | 180-302 | 2-2304-LU | PIC | 81 |
| 17331 | 2-2317-HI | Lester | 69 | 180-302 | 2-2304-LU-1 | PIC | 81 |
| 17332 | 2-1738-MI-1 | Lester | 86 | 180-302A | 2-2304-LU | PIC | 81 |
| 17341-63013 | 2-2107-ND | Kubota | 105 | 180-302A | 2-2304-LU-1 | PIC | 81 |
| 17341-63015 | 2-2107-ND | Kubota | 105 | 180-303 | 2-2293-LU | PIC | 80 |
| 17353 | 2-2710-ND-2 | Lester | 101 | 180-304 | 2-2290-LU | PIC | 80 |
| 17362 | 2-1750-ND | Lester | 103 | 180-305 | 2-2292-LU | PIC | 80 |
| 17367 | 2-1960-ND | Lester | 104 | 180-305 | 2-2292-LU-1 | PIC | 80 |
| 17367 | 2-1960-ND-2 | Lester | 104 | 180-306 | 2-2340-LU | PIC | 81 |
| 17371 | 2-2045-ND | Lester | 100 | 180-306 | 2-2340-LU-1 | PIC | 81 |
| 17381-63014 | 2-2733-ND-2 | Kubota | 110 | 180-306A | 2-2340-LU | PIC | 81 |
| 17390 | 2-1526-ND | Lester | 102 | 180-306A | 2-2340-LU-1 | PIC | 81 |
| 17391 | 2-1751-ND-2 | Lester | 103 | 180-307 | 2-2303-LU | PIC | 80 |
| 17437 | 2-1444-MI | Lester | 92 | 180-307B | 2-2303-LU | PIC | 80 |
| 17437 | 2-1444-MI-9 | Lester | 92 | 180-308 | 2-2340-LU | PIC | 81 |
| 17466 | 2-1398-ND-2 | Lester | 102 | 180-308 | 2-2340-LU-1 | PIC | 81 |
| 17549 | 2-1717-ND | Lester | 102 | 180-308B | 2-2340-LU | PIC | 81 |
| 17573 | 2-1807-ND-2 | Lester | 104 | 180-308B | 2-2340-LU-1 | PIC | 81 |
| 17574 | 2-1822-ND | Lester | 104 | 180-308C | 2-2340-LU | PIC | 81 |
| 17577 | 2-1747-MI | Lester | 91 | 180-308C | 2-2340-LU-1 | PIC | 81 |
| 17578 | 2-1748-MI-1 | Lester | 92 | 180-309 | 2-2281-LU | PIC | 79 |
| 17615 | 2-2263-ND | Lester | 107 | 180-309 | 2-2281-LU-1 | PIC | 79 |
| 17618 | 2-2279-ND | Lester | 101 | 18031 | 50-9108 | Lester | 6 |
| 17619 | 2-1960-ND | Lester | 104 | 180-310 | 2-2281-LU | PIC | 79 |
| 17619 | 2-1960-ND-2 | Lester | 104 | 180-310 | 2-2281-LU-1 | PIC | 79 |
| 17639 | 2-2302-LU | Lester | 79 | 180-311 | 2-2291-LU | PIC | 80 |
| 17639 | 2-2302-LU-1 | Lester | 79 | 180-311A | 2-2291-LU | PIC | 80 |
| 17642 | 2-2300-LU | Lester | 78 | 180-313 | 2-2458-LU | PIC | 81 |
| 17642 | 2-2300-LU-1 | Lester | 78 | 180-313 | 2-2458-LU-1 | PIC | 81 |
| 17643 | 2-2686-LU | Lester | 79 | 180-313A | 2-2458-LU | PIC | 81 |
| 17644 | 2-2301-LU | Lester | 78 | 180-313A | 2-2458-LU-1 | PIC | 81 |
| 17645 | 2-2305-LU | Lester | 79 | 180-313B | 2-2458-LU | PIC | 81 |
| 17646 | 2-2293-LU | Lester | 80 | 180-313B | 2-2458-LU-1 | PIC | 81 |
| 17647 | 2-2687-LU | Lester | 81 | 180-313C | 2-2458-LU | PIC | 81 |
| 17648 | 2-2291-LU | Lester | 80 | 180-313C | 2-2458-LU-1 | PIC | 81 |
| 17649 | 2-2458-LU | Lester | 81 | 180-313D | 2-2458-LU | PIC | 81 |
| 17649 | 2-2458-LU-1 | Lester | 81 | 180-313D | 2-2458-LU-1 | PIC | 81 |
| 17650 | 2-2340-LU | Lester | 81 | 180-316 | 2-2340-LU | PIC | 81 |
| 17650 | 2-2340-LU-1 | Lester | 81 | 180-316 | 2-2340-LU-1 | PIC | 81 |
| 17651 | 2-2340-LU | Lester | 81 | 180-317 | 2-2301-LU | PIC | 78 |
| 17651 | 2-2340-LU-1 | Lester | 81 | 180-319 | 2-2295-LU | PIC | 78 |
| 17652 | 2-2340-LU | Lester | 81 | 180-319 | 2-2295-LU-1 | PIC | 78 |
| 17652 | 2-2340-LU-1 | Lester | 81 | 180-319A | 2-2295-LU | PIC | 78 |
| 17653 | 2-2292-LU | Lester | 80 | 180-319A | 2-2295-LU-1 | PIC | 78 |
| 17653 | 2-2292-LU-1 | Lester | 80 | 18032 | 2-2284-BO | Lester | 4 |
| 17785 | 2-1981-ND-2 | Lester | 104 | 18033 | 50-9122-1 | Lester | 7 |
| 17788 | 2-1983-ND | Lester | 104 | 180-348 | 2-2305-LU | PIC | 79 |
| 17801 | 2-2320-HI-1 | Lester | 72 | 180-348A | 2-2305-LU | PIC | 79 |
| 17802 | 2-2197-ND | Lester | 106 | 180-349 | 2-2281-LU | PIC | 79 |
| 17823 | 2-2327-ND | Lester | 108 | 180-349 | 2-2281-LU-1 | PIC | 79 |
| 1785AC | 82-6885 | Fenner Stone | 117 | 180-349A | 2-2281-LU | PIC | 79 |
| 1785AC | 82-7851 | Fenner Stone | 118 | 180-349A | 2-2281-LU-1 | PIC | 79 |
| 17875 | 2-2722-ND-2 | Lester | 110 | 180-349B | 2-2281-LU | PIC | 79 |
| 1787AC | 82-6885 | Fenner Stone | 117 | 180-349B | 2-2281-LU-1 | PIC | 79 |
| 1787AC | 82-7851 | Fenner Stone | 118 | 180-349C | 2-2281-LU | PIC | 79 |
| 17880 | 2-2548-ND | Lester | 108 | 180-349C | 2-2281-LU-1 | PIC | 79 |
| 1788AC | 82-7861 | Fenner Stone | 118 | 180-349E | 2-2281-LU | PIC | 79 |
| 17892 | 2-2455-ND | Lester | 108 | 180-349E | 2-2281-LU-1 | PIC | 79 |
| 1789AC | 82-6885 | Fenner Stone | 117 | 180-349F | 2-2281-LU | PIC | 79 |
| 1789AC | 82-7851 | Fenner Stone | 118 | 180-349F | 2-2281-LU-1 | PIC | 79 |
| 17932 | 2-2725-MI | Lester | 93 | 180-353 | 2-2300-LU | PIC | 78 |

CROSS REFERENCE

CROSS REFERENCE - REF# to CATALOG#

| Mfr. Part# | Catalog# | Mfr. Name | Pg. # | Mfr. Part# | Catalog# | Mfr. Name | Pg. # |
|---------------|-------------|-----------|-------|------------|-------------|--------------|-------|
| 180-353 | 2-2300-LU-1 | PIC | 78 | 18197 | 2-2239-ND | Lester | 107 |
| 180-353A | 2-2300-LU | PIC | 78 | 18198 | 2-2203-ND | Lester | 106 |
| 180-353A | 2-2300-LU-1 | PIC | 78 | 182-105 | 2-2283-BO | PIC | 4 |
| 180-357 | 50-9202 | PIC | 79 | 182-118 | 50-9122-1 | PIC | 7 |
| 180-358 | 2-2296-LU | PIC | 78 | 182-140 | 2-2325-BO | PIC | 5 |
| 180-359 | 2-2282-LU | PIC | 80 | 182-148 | 50-9105-1 | PIC | 6 |
| 180-359A | 2-2282-LU | PIC | 80 | 18215 | 2-2319-HI | Lester | 72 |
| 180-360 | 2-2302-LU | PIC | 79 | 182-154 | 50-9101-1 | PIC | 6 |
| 180-360 | 2-2302-LU-1 | PIC | 79 | 182-158 | 2-2297-BO | PIC | 4 |
| 180-360A | 2-2302-LU | PIC | 79 | 182-160 | 50-9900 | PIC | 49 |
| 180-360A | 2-2302-LU-1 | PIC | 79 | 182-162 | 50-9100-1 | PIC | 5 |
| 180-360B | 2-2302-LU | PIC | 79 | 182-168 | 50-9110-1 | PIC | 7 |
| 180-360B | 2-2302-LU-1 | PIC | 79 | 182-188 | 50-9124-1 | PIC | 7 |
| 180-361 | 2-2301-LU | PIC | 78 | 182-202 | 50-9900 | PIC | 49 |
| 180-366 | 50-9202 | PIC | 79 | 18230 | 2-1946-BO | Lester | 7 |
| 180-381 | 2-2686-LU | PIC | 79 | 18232 | 2-2736-BO-2 | Lester | 8 |
| 180-383 | 2-2687-LU | PIC | 81 | 18238 | 2-2086-MI | Lester | 92 |
| 180-383A | 2-2687-LU | PIC | 81 | 18239 | 2-2087-MI | Lester | 89 |
| 180-387 | 2-2459-LU | PIC | 81 | 18239 | 2-2087-MI-1 | Lester | 89 |
| 180-389A | 2-2300-LU | PIC | 78 | 18240 | 2-2228-MI | Lester | 91 |
| 180-389A | 2-2300-LU-1 | PIC | 78 | 18241 | 2-2229-MI | Lester | 91 |
| 180-389D | 2-2300-LU | PIC | 78 | 18242 | 2-1913-MI-1 | Lester | 89 |
| 180-389D | 2-2300-LU-1 | PIC | 78 | 18245 | 2-2103-MI | Lester | 90 |
| 18050 | 2-1193-HI | Lester | 69 | 18251 | 2-2285-BO | Lester | 4 |
| 18054 | 2-2012-HI | Lester | 70 | 18254 | 2-2299-BO | Lester | 5 |
| 18056 | 2-1855-HI | Lester | 69 | 182-549 | 2-2666 | PIC | 109 |
| 18058 | 2-2321-HI | Lester | 72 | 18261 | 2-2295-LU | Lester | 78 |
| 18059 | 2-2037-HI | Lester | 70 | 18261 | 2-2295-LU-1 | Lester | 78 |
| 18061 | 2-2014-HI | Lester | 70 | 18263 | 2-2296-LU | Lester | 78 |
| 18062 | 2-2037-HI | Lester | 70 | 18274 | 2-2072-ND | Lester | 104 |
| 18065 | 2-2459-LU | Lester | 81 | 18280 | 2-2230-HI | Lester | 71 |
| 18067 | 2-1776-HI | Lester | 70 | 18281 | 2-2100-HI | Lester | 71 |
| 18076 | 2-2828-NK | Lester | 94 | 18284 | 2-2231-HI | Lester | 71 |
| 18084 | 2-2729-NK-2 | Lester | 94 | 18285 | 2-2264-HI | Lester | 72 |
| 18087 | 2-2730-NK-2 | Lester | 94 | 18287 | 2-2101-HI-2 | Lester | 71 |
| 18090 | 2-2283-BO | Lester | 4 | 18289 | 2-2737-HI-2 | Lester | 69 |
| 18091 | 2-2284-BO | Lester | 4 | 18299 | 2-2006-HI | Lester | 70 |
| 18092 | 2-2283-BO | Lester | 4 | 18343 | 2-2666 | Lester | 109 |
| 18093 | 50-9122-1 | Lester | 7 | 18360 | 2-2355-BO | Lester | 8 |
| 18096 | 2-1728-MI-3 | Lester | 92 | 18360 | 2-2355-BO-1 | Lester | 8 |
| 18097 | 2-2089-MI | Lester | 86 | 18364 | 2-2770-NK | Lester | 94 |
| 18099 | 2-2094-MI | Lester | 90 | 18369 | 2-2362-BO | Lester | 8 |
| 18099A | 2-2094-MI | Lester | 90 | 18371 | 2-2297-BO | Lester | 4 |
| 18100 | 2-1951-NK-1 | Lester | 93 | 18375 | 50-9117 | Lester | 7 |
| 18107 | 2-2731-NK-2 | Lester | 94 | 18387 | 2-2298-BO | Lester | 4 |
| 18110 | 2-1736-HI-1 | Lester | 68 | 18395 | 2-2569-MI | Lester | 93 |
| 1-81100-141-0 | 2-2105-ND | Isuzu | 105 | 18406 | 2-2356-ND-1 | Lester | 108 |
| 1-81100-189-0 | 2-1951-NK-1 | Isuzu | 93 | 18419 | 2-2656-ND | Lester | 109 |
| 1-81100-189-1 | 2-1951-NK-1 | Isuzu | 93 | 18449 | 2-2099-ND | Lester | 105 |
| 1-81100-191-0 | 2-1951-NK-1 | Isuzu | 93 | 18485 | 2-2307-MD | Lester | 83 |
| 1-81100-234-0 | 2-1745-ND-1 | Isuzu | 103 | 18486 | 2-2306-MD | Lester | 83 |
| 1-81100-234-1 | 2-1745-ND-1 | Isuzu | 103 | 18487 | 2-2308-MD | Lester | 83 |
| 1-81100-246-1 | 2-2234-ND | Isuzu | 107 | 18490 | 2-2318-HI | Lester | 72 |
| 1-81100-253-0 | 2-1951-NK-1 | Isuzu | 93 | 18491 | 2-2758-HI-2 | Lester | 73 |
| 1-81100-253-1 | 2-1951-NK-1 | Isuzu | 93 | 185046150 | 1-2316-01HI | Ishikawajima | 65 |
| 1-81100-259-0 | 2-1951-NK-1 | Isuzu | 93 | 185046320 | 1-2480-01MI | Ishikawajima | 85 |
| 18113 | 50-9117 | Lester | 7 | 185086052 | 2-2317-HI | Ishikawajima | 69 |
| 18139 | 2-2732-ND-2 | Lester | 110 | 185086321 | 2-2007-HI | Ishikawajima | 69 |
| 18141 | 2-2733-ND-2 | Lester | 110 | 185086410 | 2-1780-MI | Ishikawajima | 88 |
| 18142 | 2-2660-ND | Lester | 109 | 185086510 | 2-2227-MI | Ishikawajima | 91 |
| 18144 | 2-2107-ND | Lester | 105 | 185086510 | 2-2227-MI-2 | Ishikawajima | 91 |
| 18145 | 2-2734-ND-2 | Lester | 110 | 185086520 | 2-2732-ND-2 | Ishikawajima | 110 |
| 18148 | 2-2735-ND-2 | Lester | 111 | 185086530 | 2-2732-ND-2 | Ishikawajima | 110 |
| 18151 | 2-2238-ND | Lester | 107 | 18508-6550 | 2-2569-MI | Ishikawajima | 93 |
| 18158 | 2-2655-ND | Lester | 109 | 18508-6551 | 2-2569-MI | Ishikawajima | 93 |
| 18163 | 2-2102-MI | Lester | 90 | 185086560 | 2-1780-MI | Ishikawajima | 88 |
| 18168 | 2-2093-MI | Lester | 90 | 185086560 | 2-2086-MI | Ishikawajima | 92 |
| 18171 | 2-2024-MI | Lester | 89 | 18508660 | 2-2553-BO | Perkins | 8 |
| 18175 | 2-1960-ND | Lester | 104 | 18508661 | 2-2690-BO | Perkins | 9 |
| 18175 | 2-1960-ND-2 | Lester | 104 | 185-199 | 2-1951-NK-1 | PIC | 93 |
| 18181 | 2-2104-ND | Lester | 105 | 185-199A | 2-1951-NK-1 | PIC | 93 |
| 18190 | 2-2105-ND | Lester | 105 | 185-201 | 2-2731-NK-2 | PIC | 94 |

CROSS REFERENCE - REF# to CATALOG#

| Mfr. Part No. | Catalog No. | Mfr. Name | Pg. # | Mfr. Part No. | Catalog No. | Mfr. Name | Pg. # |
|---------------|---------------|-----------------|-------|---------------|---------------|------------|-------|
| 185-206 | 2-2729-NK-2 | PIC | 94 | 19010157 | 1-1915-00DR | Delco-Remy | 11 |
| 185-211 | 2-1951-NK-1 | PIC | 93 | 19010158 | 1-1915-00DR | Delco-Remy | 11 |
| 185-211B | 2-1951-NK-1 | PIC | 93 | 19010159 | 1-1915-00DR | Delco-Remy | 11 |
| 185-2166 | 2-2007-HI | Onan | 69 | 19010160 | 1-1915-00DR | Delco-Remy | 11 |
| 185-226 | 2-2828-NK | PIC | 94 | 19010164 | 1-1915-00DR | Delco-Remy | 11 |
| 185-237 | 2-2730-NK-2 | PIC | 94 | 19010165 | 1-1918-00DR | Delco-Remy | 12 |
| 185-289 | 2-1951-NK-1 | PIC | 93 | 19010166 | 1-1918-00DR | Delco-Remy | 12 |
| 18571 | 2-2773-ND | Lester | 111 | 19010168 | 1-2334-00DR | Delco-Remy | 14 |
| 18572 | 2-2774-ND | Lester | 111 | 19010168 | 1-2334-00DR-3 | Delco-Remy | 14 |
| 18577 | 2-2886-ND | Lester | 111 | 19010170 | 1-1918-00DR | Delco-Remy | 12 |
| 186-103A | 2-2222-ND | PIC | 106 | 19010171 | 1-1918-00DR | Delco-Remy | 12 |
| 186-112 | 2-2108-ND | PIC | 106 | 19010172 | 1-1918-00DR | Delco-Remy | 12 |
| 1868-283-M2 | 2-2292-LU | Massey Ferguson | 80 | 19010173 | 1-1918-00DR | Delco-Remy | 12 |
| 1868-283-M2 | 2-2292-LU-1 | Massey Ferguson | 80 | 19010174 | 1-1918-00DR | Delco-Remy | 12 |
| 1868-283-M3 | 2-2292-LU | Massey Ferguson | 80 | 19010175 | 1-2299-00DR | Delco-Remy | 13 |
| 1868-283-M3 | 2-2292-LU-1 | Massey Ferguson | 80 | 19010176 | 1-1918-00DR | Delco-Remy | 12 |
| 1868-283-M5 | 2-2292-LU | Massey Ferguson | 80 | 19010181 | 1-2297-00DR | Delco-Remy | 13 |
| 1868-283-M5 | 2-2292-LU-1 | Massey Ferguson | 80 | 19010182 | 1-2291-00DR | Delco-Remy | 12 |
| 1876552 | 2-1595-DR | Delco-Remy | 48 | 19010183 | 1-2299-00DR | Delco-Remy | 13 |
| 1876553 | 2-1601-DR-2 | Delco-Remy | 48 | 19010184 | 1-2299-00DR | Delco-Remy | 13 |
| 1876555 | 2-1593-DR | Delco-Remy | 48 | 19010189 | 1-2299-00DR | Delco-Remy | 13 |
| 1876680 | 20-102-1 | Delco-Remy | 10 | 19010190 | 1-1915-00DR | Delco-Remy | 11 |
| 188873 | 2-2355-BO | Valeo | 8 | 19010191 | 1-1918-00DR | Delco-Remy | 12 |
| 188873 | 2-2355-BO-1 | Valeo | 8 | 19010192 | 1-2299-00DR | Delco-Remy | 13 |
| 18931 | 50-9115 | Lester | 7 | 19010196 | 1-2300-00DR | Delco-Remy | 14 |
| 18948 | 2-2690-BO | Lester | 9 | 19010199 | 1-2291-00DR | Delco-Remy | 12 |
| 18949 | 2-2553-BO | Lester | 8 | 19010202 | 1-2334-00DR | Delco-Remy | 14 |
| 18960 | 2-2233-HI | Lester | 71 | 19010202 | 1-2334-00DR-3 | Delco-Remy | 14 |
| 18967 | 2-2638 | Lester | 93 | 19010612 | 2-2748-DR-2 | Delco-Remy | 28 |
| 19009950 | 1-2427-30DR | Delco-Remy | 11 | 19011004 | 1-2571-00DR | Delco-Remy | 16 |
| 19009951 | 1-2427-30DR | Delco-Remy | 11 | 19011015 | 1-2571-00DR | Delco-Remy | 16 |
| 19009952 | 1-2427-30DR | Delco-Remy | 11 | 19011019 | 1-2571-00DR | Delco-Remy | 16 |
| 19009956 | 1-2427-30DR | Delco-Remy | 11 | 19011104 | 1-2678-00DR | Delco-Remy | 19 |
| 19010001 | 20-121-1 | Delco-Remy | 16 | 19011150 | 1-2077-00DR-1 | Delco-Remy | 19 |
| 19010003 | 1-2301-00DR | Delco-Remy | 17 | 19011151 | 1-2077-00DR-1 | Delco-Remy | 19 |
| 19010007 | 1-2301-00DR | Delco-Remy | 17 | 19011152 | 1-2057-00DR-1 | Delco-Remy | 19 |
| 19010009 | 1-2301-00DR | Delco-Remy | 17 | 19011153 | 1-2558-00DR-1 | Delco-Remy | 19 |
| 19010010 | 1-2301-00DR | Delco-Remy | 17 | 19011154 | 1-2077-00DR-1 | Delco-Remy | 19 |
| 19010011 | 1-2301-00DR | Delco-Remy | 17 | 19011155 | 1-2057-00DR-1 | Delco-Remy | 19 |
| 19010012 | 1-2301-00DR | Delco-Remy | 17 | 19011156 | 1-2057-00DR-1 | Delco-Remy | 19 |
| 19010013 | 1-2301-00DR | Delco-Remy | 17 | 19011157 | 1-2060-00DR-1 | Delco-Remy | 20 |
| 19010014 | 1-2301-00DR | Delco-Remy | 17 | 19011158 | 1-2077-00DR-1 | Delco-Remy | 19 |
| 19010019 | 1-2301-00DR | Delco-Remy | 17 | 19011159 | 1-2057-00DR-1 | Delco-Remy | 19 |
| 19010021 | 1-2301-00DR | Delco-Remy | 17 | 19011160 | 1-2077-00DR-1 | Delco-Remy | 19 |
| 19010100 | 1-1915-00DR | Delco-Remy | 11 | 19011161 | 1-2057-00DR-1 | Delco-Remy | 19 |
| 19010101 | 1-2297-00DR | Delco-Remy | 13 | 19011162 | 1-2077-00DR-1 | Delco-Remy | 19 |
| 19010103 | 1-1915-00DR | Delco-Remy | 11 | 19011163 | 1-2057-00DR-1 | Delco-Remy | 19 |
| 19010105 | 1-2297-00DR | Delco-Remy | 13 | 19011166 | 1-2057-00DR-1 | Delco-Remy | 19 |
| 19010108 | 1-2291-00DR | Delco-Remy | 12 | 19011167 | 1-2078-00DR-1 | Delco-Remy | 20 |
| 19010111 | 1-2291-00DR | Delco-Remy | 12 | 19011168 | 1-2680-00DR | Delco-Remy | 20 |
| 19010112 | 1-1916-00DR | Delco-Remy | 12 | 19011170 | 1-2078-00DR-1 | Delco-Remy | 20 |
| 19010113 | 1-1917-00DR | Delco-Remy | 12 | 19011171 | 1-2057-00DR-1 | Delco-Remy | 19 |
| 19010114 | 1-1915-00DR | Delco-Remy | 11 | 19011173 | 1-2057-00DR-1 | Delco-Remy | 19 |
| 19010115 | 1-2300-00DR | Delco-Remy | 14 | 19011174 | 1-2077-00DR-1 | Delco-Remy | 19 |
| 19010116 | 1-1918-00DR | Delco-Remy | 12 | 19011175 | 1-2558-00DR-1 | Delco-Remy | 19 |
| 19010120 | 1-1918-00DR | Delco-Remy | 12 | 19011177 | 1-2304-00DR-1 | Delco-Remy | 20 |
| 19010126 | 1-2334-00DR | Delco-Remy | 14 | 19011196 | 1-2558-00DR-1 | Delco-Remy | 19 |
| 19010126 | 1-2334-00DR-3 | Delco-Remy | 14 | 19011208 | 1-2680-00DR | Delco-Remy | 20 |
| 19010127 | 1-2334-00DR | Delco-Remy | 14 | 19011211 | 1-2057-00DR-1 | Delco-Remy | 19 |
| 19010127 | 1-2334-00DR-3 | Delco-Remy | 14 | 19011212 | 1-2057-00DR-1 | Delco-Remy | 19 |
| 19010134 | 1-1918-00DR | Delco-Remy | 12 | 19011213 | 1-2060-00DR-1 | Delco-Remy | 20 |
| 19010136 | 1-1915-00DR | Delco-Remy | 11 | 19011214 | 1-2078-00DR-1 | Delco-Remy | 20 |
| 19010137 | 1-1918-00DR | Delco-Remy | 12 | 19011216 | 1-2304-00DR-1 | Delco-Remy | 20 |
| 19010138 | 1-2299-00DR | Delco-Remy | 13 | 19011260 | 1-2563-00DR | Delco-Remy | 21 |
| 19010141 | 1-1915-00DR | Delco-Remy | 11 | 19011400 | 2-2357-DR-1 | Delco-Remy | 34 |
| 19010146 | 1-1915-00DR | Delco-Remy | 11 | 19011402 | 2-2704-DR-2 | Delco-Remy | 34 |
| 19010147 | 1-2300-00DR | Delco-Remy | 14 | 19011403 | 2-2389-DR | Delco-Remy | 34 |
| 19010150 | 1-1918-00DR | Delco-Remy | 12 | 19011409 | 2-2391-DR | Delco-Remy | 34 |
| 19010153 | 1-1918-00DR | Delco-Remy | 12 | 190-114A | 2-1682-ND | PIC | 100 |
| 19010154 | 1-1915-00DR | Delco-Remy | 11 | 190-114D | 2-1682-ND | PIC | 100 |
| 19010155 | 1-1915-00DR | Delco-Remy | 11 | 19011500 | 2-2001-DR | Delco-Remy | 37 |
| 19010156 | 1-2299-00DR | Delco-Remy | 13 | 19011501 | 2-2822-DR | Delco-Remy | 40 |

CROSS REFERENCE

CROSS REFERENCE - REF# to CATALOG#

| Mfr. Part# | Catalog# | Mfr. Name | Pg. # | Mfr. Part# | Catalog# | Mfr. Name | Pg. # |
|-------------|---------------|------------|-------|--------------|-------------|-----------------|-------|
| 19011504 | 2-2823-DR | Delco-Remy | 40 | 19024205 | 50-9100-1 | Delco-Remy | 5 |
| 19011505 | 2-2350-DR | Delco-Remy | 39 | 19024234 | 50-9110-1 | Delco-Remy | 7 |
| 19011505 | 2-2350-DR-2 | Delco-Remy | 38 | 19024235 | 50-9109-1 | Delco-Remy | 6 |
| 19011506 | 2-2347-DR-1 | Delco-Remy | 38 | 19024242 | 50-9108 | Delco-Remy | 6 |
| 19011506 | 2-2352-DR-1 | Delco-Remy | 39 | 19024252 | 50-9124-1 | Delco-Remy | 7 |
| 19011507 | 2-2345-DR-1 | Delco-Remy | 38 | 19024253 | 50-9105-1 | Delco-Remy | 6 |
| 19011509 | 2-2348-DR | Delco-Remy | 38 | 19024254 | 2-2463-BO | Delco-Remy | 8 |
| 19011511 | 2-2349-DR | Delco-Remy | 38 | 19024256 | 50-9122-1 | Delco-Remy | 7 |
| 19011511 | 2-2349-DR-1 | Delco-Remy | 38 | 19024260 | 2-2285-BO | Delco-Remy | 4 |
| 19011512 | 2-2364-DR | Delco-Remy | 39 | 19024272 | 2-2325-BO | Delco-Remy | 5 |
| 19011514 | 2-2353-DR-1 | Delco-Remy | 39 | 19024272 | 50-9101-1 | Delco-Remy | 6 |
| 19011516 | 2-2347-DR-1 | Delco-Remy | 38 | 19025100 | 1-2711-00BO | Delco-Remy | 2 |
| 19011518 | 2-2347-DR-1 | Delco-Remy | 38 | 19025113 | 1-2711-00BO | Delco-Remy | 2 |
| 19011518 | 2-2352-DR-1 | Delco-Remy | 39 | 19026026 | 2-2375-DR | Delco-Remy | 37 |
| 19011521 | 2-2367-DR | Delco-Remy | 39 | 19026026 | 2-2375-DR-1 | Delco-Remy | 37 |
| 19011522 | 2-2345-DR-1 | Delco-Remy | 38 | 19026027 | 2-2377-DR | Delco-Remy | 37 |
| 19011523 | 2-2348-DR | Delco-Remy | 38 | 19026027 | 2-2377-DR-1 | Delco-Remy | 37 |
| 19011524 | 2-2349-DR | Delco-Remy | 38 | 19026028 | 2-2372-DR | Delco-Remy | 37 |
| 19011524 | 2-2349-DR-1 | Delco-Remy | 38 | 19026029 | 2-2372-DR | Delco-Remy | 37 |
| 19011529 | 2-2366-DR | Delco-Remy | 39 | 19026030 | 2-2375-DR | Delco-Remy | 37 |
| 19011530 | 2-2366-DR | Delco-Remy | 39 | 19026030 | 2-2375-DR-1 | Delco-Remy | 37 |
| 19011531 | 2-2350-DR | Delco-Remy | 39 | 19026032 | 2-2379-DR | Delco-Remy | 37 |
| 19011531 | 2-2350-DR-2 | Delco-Remy | 38 | 190-280 | 2-2732-ND-2 | PIC | 110 |
| 19011812 | 2-1397-ND-1 | Delco-Remy | 102 | 190-296 | 2-2733-ND-2 | PIC | 110 |
| 19013-63011 | 2-1960-ND | Kubota | 104 | 190-302 | 2-1960-ND | PIC | 104 |
| 19013-63011 | 2-1960-ND-2 | Kubota | 104 | 190-302 | 2-1960-ND-2 | PIC | 104 |
| 19013-63012 | 2-1960-ND | Kubota | 104 | 190-313 | 2-1960-ND | PIC | 104 |
| 19013-63012 | 2-1960-ND-2 | Kubota | 104 | 190-313 | 2-1960-ND-2 | PIC | 104 |
| 19013-63013 | 2-1960-ND | Kubota | 104 | 1903-145-M91 | 2-2282-LU | Massey Ferguson | 80 |
| 19013-63013 | 2-1960-ND-2 | Kubota | 104 | 190-317 | 2-1960-ND | PIC | 104 |
| 19020300 | 1-2044-00DR | Delco-Remy | 14 | 190-317 | 2-1960-ND-2 | PIC | 104 |
| 19020302 | 1-2065-00DR | Delco-Remy | 15 | 190-318 | 2-1960-ND | PIC | 104 |
| 19020302 | 1-2065-00DR-3 | Delco-Remy | 15 | 190-318 | 2-1960-ND-2 | PIC | 104 |
| 19020303 | 1-2065-00DR | Delco-Remy | 15 | 190-359 | 2-1383-ND-2 | PIC | 102 |
| 19020303 | 1-2065-00DR-3 | Delco-Remy | 15 | 190-359A | 2-1383-ND-2 | PIC | 102 |
| 19020305 | 1-2154-00DR | Delco-Remy | 15 | 190-361 | 2-1383-ND-2 | PIC | 102 |
| 19020306 | 1-2280-00DR | Delco-Remy | 15 | 190-365 | 2-1398-ND-2 | PIC | 102 |
| 19020308 | 1-2154-00DR | Delco-Remy | 15 | 190-365A | 2-1807-ND-2 | PIC | 104 |
| 19020309 | 1-2431-00DR-3 | Delco-Remy | 15 | 190-365B | 2-1981-ND-2 | PIC | 104 |
| 19020310 | 1-2280-00DR | Delco-Remy | 15 | 190-368 | 2-1717-ND | PIC | 102 |
| 19020312 | 1-2154-00DR | Delco-Remy | 15 | 190-369 | 2-1822-ND | PIC | 104 |
| 19020354 | 1-2154-00DR | Delco-Remy | 15 | 190-369A | 2-1983-ND | PIC | 104 |
| 19020358 | 1-2065-00DR | Delco-Remy | 15 | 190-374A | 2-2107-ND | PIC | 105 |
| 19020358 | 1-2065-00DR-3 | Delco-Remy | 15 | 190-374B | 2-2107-ND | PIC | 105 |
| 19020359 | 1-2065-00DR | Delco-Remy | 15 | 190-374E | 2-2107-ND | PIC | 105 |
| 19020359 | 1-2065-00DR-3 | Delco-Remy | 15 | 190-449 | 2-2327-ND | PIC | 108 |
| 19020360 | 1-2154-00DR | Delco-Remy | 15 | 190-449A | 2-2327-ND | PIC | 108 |
| 19020362 | 1-2154-00DR | Delco-Remy | 15 | 190-450 | 2-2722-ND-2 | PIC | 110 |
| 19020363 | 1-2154-00DR | Delco-Remy | 15 | 190-500 | 2-1193-ND | PIC | 101 |
| 19020364 | 1-2065-00DR | Delco-Remy | 15 | 190-500A | 2-1193-ND | PIC | 101 |
| 19020364 | 1-2065-00DR-3 | Delco-Remy | 15 | 190-501 | 2-1193-ND | PIC | 101 |
| 19020365 | 1-2065-00DR | Delco-Remy | 15 | 190-501A | 2-1193-ND | PIC | 101 |
| 19020365 | 1-2065-00DR-3 | Delco-Remy | 15 | 190-501B | 2-1193-ND | PIC | 101 |
| 19020377 | 1-2044-00DR | Delco-Remy | 14 | 190-502 | 2-2705-ND-2 | PIC | 109 |
| 19020379 | 1-2154-00DR | Delco-Remy | 15 | 190-504 | 2-1397-ND-1 | PIC | 102 |
| 19020384 | 1-2663-00DR | Delco-Remy | 16 | 190-514 | 2-2203-ND | PIC | 106 |
| 19020385 | 1-2662-00DR | Delco-Remy | 16 | 190-519 | 2-2239-ND | PIC | 107 |
| 19020386 | 1-1916-00DR | Delco-Remy | 12 | 190-524 | 2-1737-ND | PIC | 103 |
| 19020388 | 1-2428-00DR-3 | Delco-Remy | 15 | 190-574 | 2-2732-ND-2 | PIC | 110 |
| 19020389 | 1-2428-00DR-3 | Delco-Remy | 15 | 190-578 | 2-2660-ND | PIC | 109 |
| 19020614 | 1-2488-01DR | Delco-Remy | 9 | 190-585 | 2-2734-ND-2 | PIC | 110 |
| 19020615 | 1-2489-01DR | Delco-Remy | 9 | 190-587 | 2-2735-ND-2 | PIC | 111 |
| 19020801 | 1-2065-00DR | Delco-Remy | 15 | 190-594 | 2-2655-ND | PIC | 109 |
| 19020801 | 1-2065-00DR-3 | Delco-Remy | 15 | 190-6011 | 2-2224-ND | PIC | 106 |
| 19020803 | 1-2428-00DR-3 | Delco-Remy | 15 | 190-6012 | 2-2226-ND | PIC | 107 |
| 19020804 | 1-2428-00DR-3 | Delco-Remy | 15 | 190-6013 | 2-2223-ND | PIC | 106 |
| 19020806 | 1-2044-00DR | Delco-Remy | 14 | 190-6029 | 2-2265-ND | PIC | 108 |
| 19020810 | 1-2662-00DR | Delco-Remy | 16 | 190-6037 | 2-2666 | PIC | 109 |
| 19020812 | 1-2663-00DR | Delco-Remy | 16 | 190-6057 | 2-2726-ND-2 | PIC | 110 |
| 19020889 | 1-2428-00DR-3 | Delco-Remy | 15 | 190-6128 | 2-2656-ND | PIC | 109 |
| 19020900 | 1-2570-00DR | Delco-Remy | 16 | 190-6128A | 2-2656-ND | PIC | 109 |
| 190-218 | 2-2238-ND | PIC | 107 | 190-6129 | 2-2774-ND | PIC | 111 |

CROSS REFERENCE

CROSS REFERENCE - REF# to CATALOG#

| Mfr. Part No. | Catalog No. | Mfr. Name | Pg. # | Mfr. Part No. | Catalog No. | Mfr. Name | Pg. # |
|---------------|-------------|------------|-------|---------------|---------------|--------------|-------|
| 190-6131 | 2-2773-ND | PIC | 111 | 191-1949-06 | 2-1554-MI | Onan | 85 |
| 190-6134 | 2-2886-ND | PIC | 111 | 191-1949-06 | 2-1554-MI-1 | Onan | 85 |
| 190-6135 | 2-2548-ND | PIC | 108 | 191-1949-07 | 2-1554-MI | Onan | 85 |
| 19070039 | 2-2770-NK | Delco-Remy | 94 | 191-1949-07 | 2-1554-MI-1 | Onan | 85 |
| 190-740 | 2-2234-ND | PIC | 107 | 191-1949-08 | 2-1554-MI | Onan | 85 |
| 190-754 | 2-2072-ND | PIC | 104 | 191-1949-08 | 2-1554-MI-1 | Onan | 85 |
| 190-773 | 2-2222-ND | PIC | 106 | 191-1959 | 2-1732-MI-1 | Onan | 88 |
| 190-774 | 2-2099-ND | PIC | 105 | 1917110100 | 82-6880 | Fenner Stone | 117 |
| 190-782 | 2-2232-ND | PIC | 107 | 1917110300 | 82-6880 | Fenner Stone | 117 |
| 190-799A | 2-2455-ND | PIC | 108 | 19202-63011 | 2-1960-ND | Kubota | 104 |
| 190-800 | 2-1726-ND-2 | PIC | 102 | 19202-63011 | 2-1960-ND-2 | Kubota | 104 |
| 190-801 | 2-1526-ND | PIC | 102 | 19202-63017 | 2-1960-ND | Kubota | 104 |
| 190-801A | 2-1526-ND | PIC | 102 | 19202-63017 | 2-1960-ND-2 | Kubota | 104 |
| 190-801B | 2-1526-ND | PIC | 102 | 19215-63012 | 2-2735-ND-2 | Kubota | 111 |
| 190-801D | 2-1526-ND | PIC | 102 | 19215-63013 | 2-2735-ND-2 | Kubota | 111 |
| 190-801E | 2-1526-ND | PIC | 102 | 1931AC | 82-6885 | Fenner Stone | 117 |
| 190-801F | 2-1526-ND | PIC | 102 | 1931AC | 82-7851 | Fenner Stone | 118 |
| 190-801H | 2-1526-ND | PIC | 102 | 19535 | 2-2824-MI | Lester | 92 |
| 190-801K | 2-1526-ND | PIC | 102 | 1970445 | 2-1595-DR | Delco-Remy | 48 |
| 190-802 | 2-1751-ND-2 | PIC | 103 | 1972711 | 20-102-1 | Delco-Remy | 10 |
| 190-803 | 2-1745-ND-1 | PIC | 103 | 1972723 | 20-102-1 | Delco-Remy | 10 |
| 190-810 | 2-1753-ND | PIC | 103 | 1975629 | 20-102-1 | Delco-Remy | 10 |
| 190-810A | 2-1753-ND | PIC | 103 | 1975630 | 20-102-1 | Delco-Remy | 10 |
| 190-811 | 2-2263-ND | PIC | 107 | 1976063 | 20-102-1 | Delco-Remy | 10 |
| 190-817 | 2-2106-ND | PIC | 105 | 1977081 | 2-1598-DR-2 | Delco-Remy | 48 |
| 190-820 | 2-2105-ND | PIC | 105 | 1977084 | 2-1598-DR-2 | Delco-Remy | 48 |
| 190-830 | 2-1750-ND | PIC | 103 | 1979858 | 1-2410-11DR | Delco-Remy | 9 |
| 190-830A | 2-1750-ND | PIC | 103 | 1979858 | 1-2410-11DR-1 | Delco-Remy | 9 |
| 190-832 | 2-1754-ND | PIC | 103 | 1979858 | 20-102-1 | Delco-Remy | 10 |
| 190-834 | 2-2784-ND-2 | PIC | 111 | 1979859 | 20-102-1 | Delco-Remy | 10 |
| 190-834A | 2-2784-ND-2 | PIC | 111 | 1979860 | 20-102-1 | Delco-Remy | 10 |
| 190-837 | 2-2356-ND-1 | PIC | 108 | 1979861 | 20-102-1 | Delco-Remy | 10 |
| 190-839 | 2-2197-ND | PIC | 106 | 1979862 | 20-102-1 | Delco-Remy | 10 |
| 190-840 | 2-2709-ND-2 | PIC | 110 | 1979862 | 20-102-5 | Delco-Remy | 10 |
| 190-840A | 2-2709-ND-2 | PIC | 110 | 1979863 | 20-102-1 | Delco-Remy | 10 |
| 190-840B | 2-2709-ND-2 | PIC | 110 | 1979865 | 20-102-1 | Delco-Remy | 10 |
| 190-845 | 2-2708-ND-2 | PIC | 109 | 1979865 | 20-102-5 | Delco-Remy | 10 |
| 190-848 | 2-2045-ND | PIC | 100 | 1979866 | 20-102-1 | Delco-Remy | 10 |
| 190-849 | 2-1962-ND | PIC | 100 | 1979867 | 20-102-1 | Delco-Remy | 10 |
| 190-850 | 2-2276-ND | PIC | 101 | 1979867 | 20-102-5 | Delco-Remy | 10 |
| 190-850 | 50-159-1 | PIC | 36 | 1979871 | 20-104-1 | Delco-Remy | 10 |
| 190-851 | 2-2044-ND | PIC | 100 | 1979872 | 20-104-1 | Delco-Remy | 10 |
| 190-853 | 2-2279-ND | PIC | 101 | 1979873 | 20-104-1 | Delco-Remy | 10 |
| 190-853B | 2-2279-ND | PIC | 101 | 19821-63011 | 2-1960-ND | Kubota | 104 |
| 190-857 | 2-2277-ND | PIC | 101 | 19821-63011 | 2-1960-ND-2 | Kubota | 104 |
| 190-865 | 2-2710-ND-2 | PIC | 101 | 1984277 | 20-127-1 | Delco-Remy | 18 |
| 190-865A | 2-2710-ND-2 | PIC | 101 | 1984278 | 20-104-1 | Delco-Remy | 10 |
| 190-869 | 2-2043-ND | PIC | 100 | 1984281 | 20-102-1 | Delco-Remy | 10 |
| 190-870 | 2-2710-ND-2 | PIC | 101 | 1984282 | 20-102-1 | Delco-Remy | 10 |
| 190-870A | 2-2710-ND-2 | PIC | 101 | 1987559C1 | 2-1526-ND | Case | 102 |
| 190-890 | 2-2726-ND-2 | PIC | 110 | 1987566C1 | 2-1751-ND-2 | Case | 103 |
| 190-890A | 2-2726-ND-2 | PIC | 110 | 1988603 | 2-1593-DR | Delco-Remy | 48 |
| 190-899 | 2-2104-ND | PIC | 105 | 1988603 | 2-1604-DR | Delco-Remy | 48 |
| 190-9006 | 2-1750-ND | PIC | 103 | 1988711 | 2-1592-DR | Delco-Remy | 47 |
| 190-9024 | 2-2280-ND | PIC | 101 | 1988714 | 2-1604-DR | Delco-Remy | 48 |
| 191-0734 | 2-1738-MI-1 | Onan | 86 | 1988714 | 2-1607-DR | Delco-Remy | 48 |
| 191-1052 | 2-1738-MI-1 | Onan | 86 | 1989453 | 2-1413-DR | Delco-Remy | 47 |
| 191-1394 | 2-1732-MI-1 | Onan | 88 | 1990201 | 50-108-1 | Delco-Remy | 41 |
| 191-1399 | 2-2093-MI | Onan | 90 | 1990201 | 50-108-2 | Delco-Remy | 41 |
| 191-1618 | 2-2652-MI | Onan | 91 | 1990203 | 50-103-1 | Delco-Remy | 41 |
| 19116396 | 1-2662-00DR | Delco-Remy | 16 | 1990203 | 50-103-2 | Delco-Remy | 40 |
| 191-1682-03 | 2-1738-MI-1 | Onan | 86 | 1990204 | 50-103-1 | Delco-Remy | 41 |
| 191-1807 | 2-1732-MI-1 | Onan | 88 | 1990204 | 50-103-2 | Delco-Remy | 40 |
| 191-1808-03 | 2-1738-MI-1 | Onan | 86 | 1990209 | 50-108-1 | Delco-Remy | 41 |
| 191-1808-04 | 2-1554-MI | Onan | 85 | 1990209 | 50-108-2 | Delco-Remy | 41 |
| 191-1808-04 | 2-1554-MI-1 | Onan | 85 | 1990212 | 2-2899-DR | Delco-Remy | 40 |
| 191-1808-06 | 2-1554-MI | Onan | 85 | 1990221 | 50-100-1 | Delco-Remy | 40 |
| 191-1808-06 | 2-1554-MI-1 | Onan | 85 | 1990221 | 50-100-2 | Delco-Remy | 40 |
| 191-1888 | 2-1732-MI-1 | Onan | 88 | 1990229 | 50-111 | Delco-Remy | 43 |
| 191-1949-03 | 2-1738-MI-1 | Onan | 86 | 1990229 | 50-111-1 | Delco-Remy | 43 |
| 191-1949-04 | 2-1554-MI | Onan | 85 | 1990231 | 50-111 | Delco-Remy | 43 |
| 191-1949-04 | 2-1554-MI-1 | Onan | 85 | 1990231 | 50-111-1 | Delco-Remy | 43 |

CROSS REFERENCE

CROSS REFERENCE - REF# to CATALOG#

| Mfr. Part# | Catalog# | Mfr. Name | Pg. # | Mfr. Part# | Catalog# | Mfr. Name | Pg. # |
|------------|-------------|------------|-------|------------|-----------|------------|-------|
| 1990235 | 50-111 | Delco-Remy | 43 | 1990323 | 50-108-1 | Delco-Remy | 41 |
| 1990235 | 50-111-1 | Delco-Remy | 43 | 1990323 | 50-108-2 | Delco-Remy | 41 |
| 1990237 | 50-111 | Delco-Remy | 43 | 1990324 | 50-103-1 | Delco-Remy | 41 |
| 1990237 | 50-111-1 | Delco-Remy | 43 | 1990324 | 50-103-2 | Delco-Remy | 40 |
| 1990239 | 50-111 | Delco-Remy | 43 | 1990325 | 50-100-1 | Delco-Remy | 40 |
| 1990239 | 50-111-1 | Delco-Remy | 43 | 1990325 | 50-100-2 | Delco-Remy | 40 |
| 1990241 | 2-2474-DR | Delco-Remy | 43 | 1990326 | 50-159-1 | Delco-Remy | 36 |
| 1990244 | 50-111 | Delco-Remy | 43 | 1990330 | 50-160-1 | Delco-Remy | 36 |
| 1990244 | 50-111-1 | Delco-Remy | 43 | 1990332 | 50-160-1 | Delco-Remy | 36 |
| 1990248 | 50-111 | Delco-Remy | 43 | 1990337 | 50-153-1 | Delco-Remy | 43 |
| 1990248 | 50-111-1 | Delco-Remy | 43 | 1990337 | 50-153-2 | Delco-Remy | 43 |
| 1990249 | 50-111 | Delco-Remy | 43 | 1990343 | 50-103-1 | Delco-Remy | 41 |
| 1990249 | 50-111-1 | Delco-Remy | 43 | 1990343 | 50-103-2 | Delco-Remy | 40 |
| 1990250 | 50-111 | Delco-Remy | 43 | 1990344 | 50-151-1 | Delco-Remy | 42 |
| 1990250 | 50-111-1 | Delco-Remy | 43 | 1990344 | 50-151-2 | Delco-Remy | 42 |
| 1990251 | 50-111 | Delco-Remy | 43 | 1990344 | 50-151-3 | Delco-Remy | 42 |
| 1990251 | 50-111-1 | Delco-Remy | 43 | 1990347 | 50-193-1 | Delco-Remy | 36 |
| 1990259 | 50-111 | Delco-Remy | 43 | 1990348 | 50-153-1 | Delco-Remy | 43 |
| 1990259 | 50-111-1 | Delco-Remy | 43 | 1990348 | 50-153-2 | Delco-Remy | 43 |
| 1990260 | 50-111 | Delco-Remy | 43 | 1990349 | 2-2471-DR | Delco-Remy | 41 |
| 1990260 | 50-111-1 | Delco-Remy | 43 | 1990352 | 50-153-1 | Delco-Remy | 43 |
| 1990261 | 2-2473-DR | Delco-Remy | 43 | 1990352 | 50-153-2 | Delco-Remy | 43 |
| 1990262 | 50-111 | Delco-Remy | 43 | 1990353 | 50-150-1 | Delco-Remy | 42 |
| 1990262 | 50-111-1 | Delco-Remy | 43 | 1990353 | 50-150-2 | Delco-Remy | 42 |
| 1990263 | 50-111 | Delco-Remy | 43 | 1990354 | 50-153-1 | Delco-Remy | 43 |
| 1990263 | 50-111-1 | Delco-Remy | 43 | 1990354 | 50-153-2 | Delco-Remy | 43 |
| 1990264 | 50-111 | Delco-Remy | 43 | 1990355 | 50-192-1 | Delco-Remy | 43 |
| 1990264 | 50-111-1 | Delco-Remy | 43 | 1990355 | 50-192-2 | Delco-Remy | 43 |
| 1990267 | 50-111 | Delco-Remy | 43 | 1990356 | 50-150-1 | Delco-Remy | 42 |
| 1990267 | 50-111-1 | Delco-Remy | 43 | 1990356 | 50-150-2 | Delco-Remy | 42 |
| 1990268 | 50-111 | Delco-Remy | 43 | 1990357 | 50-152-1 | Delco-Remy | 42 |
| 1990268 | 50-111-1 | Delco-Remy | 43 | 1990357 | 50-152-2 | Delco-Remy | 42 |
| 1990269 | 50-111 | Delco-Remy | 43 | 1990358 | 50-153-1 | Delco-Remy | 43 |
| 1990269 | 50-111-1 | Delco-Remy | 43 | 1990358 | 50-153-2 | Delco-Remy | 43 |
| 1990270 | 50-111 | Delco-Remy | 43 | 1990359 | 50-152-1 | Delco-Remy | 42 |
| 1990270 | 50-111-1 | Delco-Remy | 43 | 1990359 | 50-152-2 | Delco-Remy | 42 |
| 1990271 | 50-111 | Delco-Remy | 43 | 1990361 | 50-151-1 | Delco-Remy | 42 |
| 1990271 | 50-111-1 | Delco-Remy | 43 | 1990361 | 50-151-2 | Delco-Remy | 42 |
| 1990273 | 50-111 | Delco-Remy | 43 | 1990361 | 50-151-3 | Delco-Remy | 42 |
| 1990273 | 50-111-1 | Delco-Remy | 43 | 1990362 | 50-150-1 | Delco-Remy | 42 |
| 1990274 | 50-111 | Delco-Remy | 43 | 1990362 | 50-150-2 | Delco-Remy | 42 |
| 1990274 | 50-111-1 | Delco-Remy | 43 | 1990363 | 50-153-1 | Delco-Remy | 43 |
| 1990276 | 50-111 | Delco-Remy | 43 | 1990363 | 50-153-2 | Delco-Remy | 43 |
| 1990276 | 50-111-1 | Delco-Remy | 43 | 1990367 | 50-151-1 | Delco-Remy | 42 |
| 1990277 | 2-2473-DR | Delco-Remy | 43 | 1990367 | 50-151-2 | Delco-Remy | 42 |
| 1990278 | 50-111 | Delco-Remy | 43 | 1990367 | 50-151-3 | Delco-Remy | 42 |
| 1990278 | 50-111-1 | Delco-Remy | 43 | 1990368 | 50-151-1 | Delco-Remy | 42 |
| 1990283 | 50-103-1 | Delco-Remy | 41 | 1990368 | 50-151-2 | Delco-Remy | 42 |
| 1990283 | 50-103-2 | Delco-Remy | 40 | 1990368 | 50-151-3 | Delco-Remy | 42 |
| 1990284 | 50-111 | Delco-Remy | 43 | 1990370 | 50-150-1 | Delco-Remy | 42 |
| 1990284 | 50-111-1 | Delco-Remy | 43 | 1990370 | 50-150-2 | Delco-Remy | 42 |
| 1990296 | 50-108-1 | Delco-Remy | 41 | 1990372 | 2-2471-DR | Delco-Remy | 41 |
| 1990296 | 50-108-2 | Delco-Remy | 41 | 1990375 | 50-153-1 | Delco-Remy | 43 |
| 1990297 | 50-103-1 | Delco-Remy | 41 | 1990375 | 50-153-2 | Delco-Remy | 43 |
| 1990297 | 50-103-2 | Delco-Remy | 40 | 1990376 | 50-153-1 | Delco-Remy | 43 |
| 1990298 | 2-2473-DR | Delco-Remy | 43 | 1990376 | 50-153-2 | Delco-Remy | 43 |
| 1990303 | 50-108-1 | Delco-Remy | 41 | 1990378 | 50-151-1 | Delco-Remy | 42 |
| 1990303 | 50-108-2 | Delco-Remy | 41 | 1990378 | 50-151-2 | Delco-Remy | 42 |
| 1990306 | 50-108-1 | Delco-Remy | 41 | 1990378 | 50-151-3 | Delco-Remy | 42 |
| 1990306 | 50-108-2 | Delco-Remy | 41 | 1990379 | 50-150-1 | Delco-Remy | 42 |
| 1990307 | 50-104-1 | Delco-Remy | 41 | 1990379 | 50-150-2 | Delco-Remy | 42 |
| 1990307 | 50-104-2 | Delco-Remy | 41 | 1990382 | 50-151-1 | Delco-Remy | 42 |
| 1990308 | 50-113-1 | Delco-Remy | 35 | 1990382 | 50-151-2 | Delco-Remy | 42 |
| 1990309 | 50-161-1 | Delco-Remy | 36 | 1990382 | 50-151-3 | Delco-Remy | 42 |
| 1990310 | 2-1584-DR-2 | Delco-Remy | 34 | 1990383 | 50-151-1 | Delco-Remy | 42 |
| 1990312 | 50-158-1 | Delco-Remy | 36 | 1990383 | 50-151-2 | Delco-Remy | 42 |
| 1990313 | 50-162-1 | Delco-Remy | 36 | 1990383 | 50-151-3 | Delco-Remy | 42 |
| 1990315 | 50-159-1 | Delco-Remy | 36 | 1990384 | 50-151-1 | Delco-Remy | 42 |
| 1990316 | 50-162-1 | Delco-Remy | 36 | 1990384 | 50-151-2 | Delco-Remy | 42 |
| 1990317 | 50-162-1 | Delco-Remy | 36 | 1990384 | 50-151-3 | Delco-Remy | 42 |
| 1990318 | 50-159-1 | Delco-Remy | 36 | 1990385 | 50-150-1 | Delco-Remy | 42 |
| 1990319 | 50-162-1 | Delco-Remy | 36 | 1990385 | 50-150-2 | Delco-Remy | 42 |

CROSS REFERENCE

CROSS REFERENCE - REF# to CATALOG#

| Mfr. Part No. | Catalog No. | Mfr. Name | Pg. # | Mfr. Part No. | Catalog No. | Mfr. Name | Pg. # |
|---------------|-------------|------------|-------|---------------|-------------|------------|-------|
| 1990386 | .50-153-1 | Delco-Remy | 43 | 1990441 | .50-150-2 | Delco-Remy | 42 |
| 1990386 | .50-153-2 | Delco-Remy | 43 | 1990443 | .50-150-1 | Delco-Remy | 42 |
| 1990387 | .50-150-1 | Delco-Remy | 42 | 1990443 | .50-150-2 | Delco-Remy | 42 |
| 1990387 | .50-150-2 | Delco-Remy | 42 | 1990444 | .50-151-1 | Delco-Remy | 42 |
| 1990388 | .50-151-1 | Delco-Remy | 42 | 1990444 | .50-151-2 | Delco-Remy | 42 |
| 1990388 | .50-151-2 | Delco-Remy | 42 | 1990444 | .50-151-3 | Delco-Remy | 42 |
| 1990388 | .50-151-3 | Delco-Remy | 42 | 1990452 | .50-150-1 | Delco-Remy | 42 |
| 1990390 | .50-151-1 | Delco-Remy | 42 | 1990452 | .50-150-2 | Delco-Remy | 42 |
| 1990390 | .50-151-2 | Delco-Remy | 42 | 1990453 | .50-152-1 | Delco-Remy | 42 |
| 1990390 | .50-151-3 | Delco-Remy | 42 | 1990453 | .50-152-2 | Delco-Remy | 42 |
| 1990391 | .50-192-1 | Delco-Remy | 43 | 1990456 | .50-151-1 | Delco-Remy | 42 |
| 1990391 | .50-192-2 | Delco-Remy | 43 | 1990456 | .50-151-2 | Delco-Remy | 42 |
| 1990392 | .50-153-1 | Delco-Remy | 43 | 1990456 | .50-151-3 | Delco-Remy | 42 |
| 1990392 | .50-153-2 | Delco-Remy | 43 | 1990457 | .50-152-1 | Delco-Remy | 42 |
| 1990393 | .50-192-1 | Delco-Remy | 43 | 1990457 | .50-152-2 | Delco-Remy | 42 |
| 1990393 | .50-192-2 | Delco-Remy | 43 | 1990458 | .50-153-1 | Delco-Remy | 43 |
| 1990394 | .50-150-1 | Delco-Remy | 42 | 1990458 | .50-153-2 | Delco-Remy | 43 |
| 1990394 | .50-150-2 | Delco-Remy | 42 | 1990460 | .50-151-1 | Delco-Remy | 42 |
| 1990396 | .50-153-1 | Delco-Remy | 43 | 1990460 | .50-151-2 | Delco-Remy | 42 |
| 1990396 | .50-153-2 | Delco-Remy | 43 | 1990460 | .50-151-3 | Delco-Remy | 42 |
| 1990397 | .2-2471-DR | Delco-Remy | 41 | 1990461 | .50-151-1 | Delco-Remy | 42 |
| 1990398 | .50-153-1 | Delco-Remy | 43 | 1990461 | .50-151-2 | Delco-Remy | 42 |
| 1990398 | .50-153-2 | Delco-Remy | 43 | 1990461 | .50-151-3 | Delco-Remy | 42 |
| 1990399 | .50-150-1 | Delco-Remy | 42 | 1990465 | .50-153-1 | Delco-Remy | 43 |
| 1990399 | .50-150-2 | Delco-Remy | 42 | 1990465 | .50-153-2 | Delco-Remy | 43 |
| 1990400 | .50-153-1 | Delco-Remy | 43 | 1990467 | .50-150-1 | Delco-Remy | 42 |
| 1990400 | .50-153-2 | Delco-Remy | 43 | 1990467 | .50-150-2 | Delco-Remy | 42 |
| 1990403 | .50-150-1 | Delco-Remy | 42 | 1990468 | .50-153-1 | Delco-Remy | 43 |
| 1990403 | .50-150-2 | Delco-Remy | 42 | 1990468 | .50-153-2 | Delco-Remy | 43 |
| 1990404 | .50-150-1 | Delco-Remy | 42 | 1990469 | .50-150-1 | Delco-Remy | 42 |
| 1990404 | .50-150-2 | Delco-Remy | 42 | 1990469 | .50-150-2 | Delco-Remy | 42 |
| 1990405 | .50-150-1 | Delco-Remy | 42 | 1990470 | .50-153-1 | Delco-Remy | 43 |
| 1990405 | .50-150-2 | Delco-Remy | 42 | 1990470 | .50-153-2 | Delco-Remy | 43 |
| 1990409 | .50-151-1 | Delco-Remy | 42 | 1990471 | .50-150-1 | Delco-Remy | 42 |
| 1990409 | .50-151-2 | Delco-Remy | 42 | 1990471 | .50-150-2 | Delco-Remy | 42 |
| 1990409 | .50-151-3 | Delco-Remy | 42 | 1990475 | .50-153-1 | Delco-Remy | 43 |
| 1990410 | .50-151-1 | Delco-Remy | 42 | 1990475 | .50-153-2 | Delco-Remy | 43 |
| 1990410 | .50-151-2 | Delco-Remy | 42 | 1990477 | .50-153-1 | Delco-Remy | 43 |
| 1990410 | .50-151-3 | Delco-Remy | 42 | 1990477 | .50-153-2 | Delco-Remy | 43 |
| 1990412 | .50-151-1 | Delco-Remy | 42 | 1990478 | .50-153-1 | Delco-Remy | 43 |
| 1990412 | .50-151-2 | Delco-Remy | 42 | 1990478 | .50-153-2 | Delco-Remy | 43 |
| 1990412 | .50-151-3 | Delco-Remy | 42 | 1990480 | .50-150-1 | Delco-Remy | 42 |
| 1990418 | .50-151-1 | Delco-Remy | 42 | 1990480 | .50-150-2 | Delco-Remy | 42 |
| 1990418 | .50-151-2 | Delco-Remy | 42 | 1990482 | .50-104-1 | Delco-Remy | 41 |
| 1990418 | .50-151-3 | Delco-Remy | 42 | 1990482 | .50-104-2 | Delco-Remy | 41 |
| 1990420 | .50-153-1 | Delco-Remy | 43 | 1990483 | .50-153-1 | Delco-Remy | 43 |
| 1990420 | .50-153-2 | Delco-Remy | 43 | 1990483 | .50-153-2 | Delco-Remy | 43 |
| 1990421 | .50-192-1 | Delco-Remy | 43 | 1990484 | .50-192-1 | Delco-Remy | 43 |
| 1990421 | .50-192-2 | Delco-Remy | 43 | 1990484 | .50-192-2 | Delco-Remy | 43 |
| 1990422 | .50-151-1 | Delco-Remy | 42 | 1990485 | .50-151-1 | Delco-Remy | 42 |
| 1990422 | .50-151-2 | Delco-Remy | 42 | 1990485 | .50-151-2 | Delco-Remy | 42 |
| 1990422 | .50-151-3 | Delco-Remy | 42 | 1990485 | .50-151-3 | Delco-Remy | 42 |
| 1990423 | .50-153-1 | Delco-Remy | 43 | 1990487 | .50-150-1 | Delco-Remy | 42 |
| 1990423 | .50-153-2 | Delco-Remy | 43 | 1990487 | .50-150-2 | Delco-Remy | 42 |
| 1990424 | .50-153-1 | Delco-Remy | 43 | 1990490 | .2-2703-DR | Delco-Remy | 42 |
| 1990424 | .50-153-2 | Delco-Remy | 43 | 1990492 | .50-150-1 | Delco-Remy | 42 |
| 1990425 | .50-150-1 | Delco-Remy | 42 | 1990492 | .50-150-2 | Delco-Remy | 42 |
| 1990425 | .50-150-2 | Delco-Remy | 42 | 1990493 | .50-151-1 | Delco-Remy | 42 |
| 1990426 | .50-192-1 | Delco-Remy | 43 | 1990493 | .50-151-2 | Delco-Remy | 42 |
| 1990426 | .50-192-2 | Delco-Remy | 43 | 1990493 | .50-151-3 | Delco-Remy | 42 |
| 1990428 | .50-192-1 | Delco-Remy | 43 | 1990495 | .50-153-1 | Delco-Remy | 43 |
| 1990428 | .50-192-2 | Delco-Remy | 43 | 1990495 | .50-153-2 | Delco-Remy | 43 |
| 1990429 | .50-150-1 | Delco-Remy | 42 | 1990496 | .50-150-1 | Delco-Remy | 42 |
| 1990429 | .50-150-2 | Delco-Remy | 42 | 1990496 | .50-150-2 | Delco-Remy | 42 |
| 1990432 | .50-103-1 | Delco-Remy | 41 | 1990497 | .50-152-1 | Delco-Remy | 42 |
| 1990432 | .50-103-2 | Delco-Remy | 40 | 1990497 | .50-152-2 | Delco-Remy | 42 |
| 1990433 | .50-152-1 | Delco-Remy | 42 | 1993703 | .50-100-1 | Delco-Remy | 40 |
| 1990433 | .50-152-2 | Delco-Remy | 42 | 1993703 | .50-100-2 | Delco-Remy | 40 |
| 1990437 | .50-151-1 | Delco-Remy | 42 | 1993704 | .50-103-1 | Delco-Remy | 41 |
| 1990437 | .50-151-2 | Delco-Remy | 42 | 1993704 | .50-103-2 | Delco-Remy | 40 |
| 1990437 | .50-151-3 | Delco-Remy | 42 | 1993705 | .50-161-1 | Delco-Remy | 36 |
| 1990441 | .50-150-1 | Delco-Remy | 42 | 1993707 | .50-160-1 | Delco-Remy | 36 |

CROSS REFERENCE

CROSS REFERENCE - REF# to CATALOG#

| Mfr. Part# | Catalog# | Mfr. Name | Pg. # | Mfr. Part# | Catalog# | Mfr. Name | Pg. # |
|------------|------------|------------|-------|------------|--------------|--------------|-------|
| 1993712 | .50-161-1 | Delco-Remy | .36 | 1993841 | .50-111 | Delco-Remy | .43 |
| 1993713 | .50-162-1 | Delco-Remy | .36 | 1993841 | .50-111-1 | Delco-Remy | .43 |
| 1993721 | .50-160-1 | Delco-Remy | .36 | 1993842 | .50-151-1 | Delco-Remy | .42 |
| 1993726 | .50-161-1 | Delco-Remy | .36 | 1993842 | .50-151-2 | Delco-Remy | .42 |
| 1993729 | .50-160-1 | Delco-Remy | .36 | 1993842 | .50-151-3 | Delco-Remy | .42 |
| 1993732 | .50-160-1 | Delco-Remy | .36 | 1993846 | .50-103-1 | Delco-Remy | .41 |
| 1993738 | .50-113-1 | Delco-Remy | .35 | 1993846 | .50-103-2 | Delco-Remy | .40 |
| 1993742 | .50-160-1 | Delco-Remy | .36 | 1993850 | .50-113-1 | Delco-Remy | .35 |
| 1993754 | .50-159-1 | Delco-Remy | .36 | 1993852 | .50-111 | Delco-Remy | .43 |
| 1993759 | .50-113-1 | Delco-Remy | .35 | 1993852 | .50-111-1 | Delco-Remy | .43 |
| 1993761 | .50-158-1 | Delco-Remy | .36 | 1993854 | .50-193-1 | Delco-Remy | .36 |
| 1993762 | .50-159-1 | Delco-Remy | .36 | 1993855 | .50-113-1 | Delco-Remy | .35 |
| 1993763 | .50-162-1 | Delco-Remy | .36 | 1993856 | .2-2471-DR | Delco-Remy | .41 |
| 1993767 | .50-193-1 | Delco-Remy | .36 | 1993861 | .50-160-1 | Delco-Remy | .36 |
| 1993769 | .50-161-1 | Delco-Remy | .36 | 1993864 | .2-2473-DR | Delco-Remy | .43 |
| 1993772 | .50-150-1 | Delco-Remy | .42 | 1993867 | .50-161-1 | Delco-Remy | .36 |
| 1993772 | .50-150-2 | Delco-Remy | .42 | 1993869 | .50-162-1 | Delco-Remy | .36 |
| 1993775 | .50-150-1 | Delco-Remy | .42 | 1993871 | .50-162-1 | Delco-Remy | .36 |
| 1993775 | .50-150-2 | Delco-Remy | .42 | 1993874 | .50-162-1 | Delco-Remy | .36 |
| 1993776 | .50-192-1 | Delco-Remy | .43 | 1993880 | .50-158-1 | Delco-Remy | .36 |
| 1993776 | .50-192-2 | Delco-Remy | .43 | 1993881 | .50-159-1 | Delco-Remy | .36 |
| 1993778 | .50-162-1 | Delco-Remy | .36 | 1993886 | .50-161-1 | Delco-Remy | .36 |
| 1993783 | .50-150-1 | Delco-Remy | .42 | 1993901 | .50-160-1 | Delco-Remy | .36 |
| 1993783 | .50-150-2 | Delco-Remy | .42 | 1993902 | .50-160-1 | Delco-Remy | .36 |
| 1993788 | .50-151-3 | Delco-Remy | .42 | 1993903 | .2-2207-DR-1 | Delco-Remy | .35 |
| 1993789 | .50-113-1 | Delco-Remy | .35 | 1993906 | .50-160-1 | Delco-Remy | .36 |
| 1993790 | .50-159-1 | Delco-Remy | .36 | 1993909 | .50-160-1 | Delco-Remy | .36 |
| 1993792 | .50-161-1 | Delco-Remy | .36 | 1993910 | .50-160-1 | Delco-Remy | .36 |
| 1993794 | .50-162-1 | Delco-Remy | .36 | 1993911 | .50-160-1 | Delco-Remy | .36 |
| 1993795 | .50-150-1 | Delco-Remy | .42 | 1993924 | .50-151-1 | Delco-Remy | .42 |
| 1993795 | .50-150-2 | Delco-Remy | .42 | 1993924 | .50-151-2 | Delco-Remy | .42 |
| 1993797 | .50-152-1 | Delco-Remy | .42 | 1993924 | .50-151-3 | Delco-Remy | .42 |
| 1993797 | .50-152-2 | Delco-Remy | .42 | 1993929 | .50-152-1 | Delco-Remy | .42 |
| 1993799 | .50-159-1 | Delco-Remy | .36 | 1993929 | .50-152-2 | Delco-Remy | .42 |
| 1993802 | .50-151-1 | Delco-Remy | .42 | 1993931 | .50-162-1 | Delco-Remy | .36 |
| 1993802 | .50-151-2 | Delco-Remy | .42 | 1993932 | .50-192-1 | Delco-Remy | .43 |
| 1993802 | .50-151-3 | Delco-Remy | .42 | 1993932 | .50-192-2 | Delco-Remy | .43 |
| 1993803 | .50-153-1 | Delco-Remy | .43 | 1993935 | .50-150-1 | Delco-Remy | .42 |
| 1993803 | .50-153-2 | Delco-Remy | .43 | 1993935 | .50-150-2 | Delco-Remy | .42 |
| 1993804 | .50-152-1 | Delco-Remy | .42 | 1993937 | .50-150-1 | Delco-Remy | .42 |
| 1993804 | .50-152-2 | Delco-Remy | .42 | 1993937 | .50-150-2 | Delco-Remy | .42 |
| 1993805 | .50-151-1 | Delco-Remy | .42 | 1993938 | .50-150-1 | Delco-Remy | .42 |
| 1993805 | .50-151-2 | Delco-Remy | .42 | 1993938 | .50-150-2 | Delco-Remy | .42 |
| 1993805 | .50-151-3 | Delco-Remy | .42 | 1993939 | .50-150-1 | Delco-Remy | .42 |
| 1993806 | .50-150-1 | Delco-Remy | .42 | 1993939 | .50-150-2 | Delco-Remy | .42 |
| 1993806 | .50-150-2 | Delco-Remy | .42 | 1993942 | .50-150-1 | Delco-Remy | .42 |
| 1993807 | .50-153-1 | Delco-Remy | .43 | 1993942 | .50-150-2 | Delco-Remy | .42 |
| 1993807 | .50-153-2 | Delco-Remy | .43 | 1993943 | .50-150-1 | Delco-Remy | .42 |
| 1993809 | .50-152-1 | Delco-Remy | .42 | 1993943 | .50-150-2 | Delco-Remy | .42 |
| 1993809 | .50-152-2 | Delco-Remy | .42 | 1993947 | .2-1582-DR-1 | Delco-Remy | .34 |
| 1993810 | .50-151-1 | Delco-Remy | .42 | 1993961 | .50-150-1 | Delco-Remy | .42 |
| 1993810 | .50-151-2 | Delco-Remy | .42 | 1993961 | .50-150-2 | Delco-Remy | .42 |
| 1993810 | .50-151-3 | Delco-Remy | .42 | 1993963 | .50-194-1 | Delco-Remy | .37 |
| 1993813 | .2-2471-DR | Delco-Remy | .41 | 1993964 | .2-1584-DR-2 | Delco-Remy | .34 |
| 1993814 | .50-152-1 | Delco-Remy | .42 | 1993968 | .2-2473-DR | Delco-Remy | .43 |
| 1993814 | .50-152-2 | Delco-Remy | .42 | 1993973 | .2-2471-DR | Delco-Remy | .41 |
| 1993816 | .50-153-1 | Delco-Remy | .43 | 1993975 | .50-153-1 | Delco-Remy | .43 |
| 1993816 | .50-153-2 | Delco-Remy | .43 | 1993975 | .50-153-2 | Delco-Remy | .43 |
| 1993818 | .50-158-1 | Delco-Remy | .36 | 1993978 | .50-151-1 | Delco-Remy | .42 |
| 1993820 | .50-150-1 | Delco-Remy | .42 | 1993978 | .50-151-2 | Delco-Remy | .42 |
| 1993820 | .50-150-2 | Delco-Remy | .42 | 1993978 | .50-151-3 | Delco-Remy | .42 |
| 1993823 | .50-153-1 | Delco-Remy | .43 | 1993983 | .50-150-1 | Delco-Remy | .42 |
| 1993823 | .50-153-2 | Delco-Remy | .43 | 1993983 | .50-150-2 | Delco-Remy | .42 |
| 1993825 | .50-111 | Delco-Remy | .43 | 1993985 | .50-153-1 | Delco-Remy | .43 |
| 1993825 | .50-111-1 | Delco-Remy | .43 | 1993985 | .50-153-2 | Delco-Remy | .43 |
| 1993828 | .50-151-3 | Delco-Remy | .42 | 19960488 | .2-2553-BO | Yale | .8 |
| 1993833 | .50-152-1 | Delco-Remy | .42 | 19960489 | .2-2553-BO | Yale | .8 |
| 1993833 | .50-152-2 | Delco-Remy | .42 | 1997AC | .82-6885 | Fenner Stone | .117 |
| 1993836 | .50-192-1 | Delco-Remy | .43 | 1997AC | .82-7851 | Fenner Stone | .118 |
| 1993836 | .50-192-2 | Delco-Remy | .43 | 1998206 | .2-1598-DR-2 | Delco-Remy | .48 |
| 1993840 | .50-111 | Delco-Remy | .43 | 1998211 | .2-1593-DR | Delco-Remy | .48 |
| 1993840 | .50-111-1 | Delco-Remy | .43 | 1998217 | .2-1593-DR | Delco-Remy | .48 |

CROSS REFERENCE - REF# to CATALOG#

| Mfr. Part No. | Catalog No. | Mfr. Name | Pg. # | Mfr. Part No. | Catalog No. | Mfr. Name | Pg. # |
|---------------|-------------|------------|-------|---------------|---------------|---------------|-------|
| 1998222 | 2-1593-DR | Delco-Remy | 48 | 1C3Z-11002-AA | 2-2197-FD-2 | Ford | 61 |
| 1998223 | 2-1593-DR | Delco-Remy | 48 | 1F20-18-400 | 2-2218-FD | Mazda | 64 |
| 1998226 | 2-1604-DR | Delco-Remy | 48 | 1F20-18-400A | 2-2218-FD | Mazda | 64 |
| 1998228 | 2-1598-DR-2 | Delco-Remy | 48 | 1F20-18-400B | 2-2218-FD | Mazda | 64 |
| 1998231 | 2-1598-DR-2 | Delco-Remy | 48 | 1F60-18-400 | 2-1887-FD-1 | Mazda | 63 |
| 1998234 | 2-1592-DR | Delco-Remy | 47 | 1F60-18-400A | 2-1887-FD-1 | Mazda | 63 |
| 1998235 | 2-1592-DR | Delco-Remy | 47 | 1F82-18-400 | 2-1886-FD-1 | Mazda | 63 |
| 1998238 | 2-1604-DR | Delco-Remy | 48 | 1F85-18-400 | 2-1895-FD-1 | Mazda | 63 |
| 1998241 | 2-1604-DR | Delco-Remy | 48 | 1L5T-11000-AA | 2-2218-FD | Ford | 64 |
| 1998243 | 2-1604-DR | Delco-Remy | 48 | 1L5Z-11002-AA | 2-2218-FD | Ford | 64 |
| 1998246 | 2-1604-DR | Delco-Remy | 48 | 1S41-10300-BB | 1-2350-11FD-2 | Ford | 58 |
| 1998247 | 2-1604-DR | Delco-Remy | 48 | 200004000 | 82-6888 | Hale | 117 |
| 1998250 | 2-1598-DR-2 | Delco-Remy | 48 | 2000041000 | 82-6887 | Hale | 117 |
| 1998256 | 2-1601-DR-2 | Delco-Remy | 48 | 2009386 | 20-502-1 | Delco-Remy | 74 |
| 1998267 | 2-2596-DR-2 | Delco-Remy | 49 | 2009669 | 20-504-1 | Delco-Remy | 74 |
| 1998275 | 2-1601-DR-2 | Delco-Remy | 48 | 2021166 | 2-2024-MI | Hyster | 89 |
| 1998293 | 2-2753-DR-2 | Delco-Remy | 49 | 20234960 | 2-2295-LU | Lister Petter | 78 |
| 1998359 | 50-8429 | Delco-Remy | 32 | 20234960 | 2-2295-LU-1 | Lister Petter | 78 |
| 1998360 | 50-8429 | Delco-Remy | 32 | 20234963 | 2-2295-LU | Lister Petter | 78 |
| 1998379 | 50-8429 | Delco-Remy | 32 | 20234963 | 2-2295-LU-1 | Lister Petter | 78 |
| 1998396 | 2-1607-DR | Delco-Remy | 48 | 203-134 | 1-1960-01MI | PIC | 84 |
| 1998397 | 2-1607-DR | Delco-Remy | 48 | 203-151 | 1-2391-01MI | PIC | 83 |
| 1998400 | 2-1592-DR | Delco-Remy | 47 | 203-152 | 1-1112-01 | PIC | 65 |
| 1998408 | 50-157-9 | Delco-Remy | 28 | 203-167 | 1-2480-01MI | PIC | 85 |
| 1998423 | 50-157-9 | Delco-Remy | 28 | 203-266 | 1-2392-01MI | PIC | 84 |
| 1998427 | 2-1413-DR | Delco-Remy | 47 | 203-266A | 1-2392-01MI | PIC | 84 |
| 1998435 | 2-1592-DR | Delco-Remy | 47 | 203-295 | 1-2062-01MI | PIC | 84 |
| 1998436 | 2-1604-DR | Delco-Remy | 48 | 203-359A | 1-2479-01MI | PIC | 84 |
| 1998438 | 2-1607-DR | Delco-Remy | 48 | 203-412 | 1-1929-01MI | PIC | 83 |
| 1998439 | 2-1604-DR | Delco-Remy | 48 | 203-447 | 1-2153-01MI | PIC | 84 |
| 1998440 | 2-1604-DR | Delco-Remy | 48 | 203-5091 | 1-2434-01MI | PIC | 83 |
| 1998441 | 2-1604-DR | Delco-Remy | 48 | 203-5093 | 1-2438-01MI | PIC | 84 |
| 1998443 | 2-1607-DR | Delco-Remy | 48 | 204-106 | 1-2316-01HI | PIC | 65 |
| 1998452 | 2-1592-DR | Delco-Remy | 47 | 204-109 | 1-1111-02HI | PIC | 64 |
| 1998456 | 50-157-9 | Delco-Remy | 28 | 204-117 | 1-1112-01 | PIC | 65 |
| 1998457 | 50-157-9 | Delco-Remy | 28 | 20413273 | 2-2686-LU | Lister Petter | 79 |
| 1998467 | 2-1592-DR | Delco-Remy | 47 | 204-142 | 1-2312-01HI | PIC | 65 |
| 1998469 | 2-1604-DR | Delco-Remy | 48 | 204-142A | 1-2332-01HI | PIC | 66 |
| 1998472 | 2-1598-DR-2 | Delco-Remy | 48 | 204-142B | 1-2332-01HI | PIC | 66 |
| 1998473 | 2-1601-DR-2 | Delco-Remy | 48 | 204-142C | 1-2332-01HI | PIC | 66 |
| 1998482 | 2-1493-DR | Delco-Remy | 47 | 204-142D | 1-2332-01HI | PIC | 66 |
| 1998490 | 50-157-9 | Delco-Remy | 28 | 204-142E | 1-2332-01HI | PIC | 66 |
| 1998491 | 2-1607-DR | Delco-Remy | 48 | 204-157 | 1-2314-01HI | PIC | 66 |
| 1998501 | 2-1598-DR-2 | Delco-Remy | 48 | 204-161 | 1-2469-01HI | PIC | 68 |
| 1998524 | 2-1413-DR | Delco-Remy | 47 | 204-169 | 1-1111-02HI | PIC | 64 |
| 1998532 | 2-1493-DR | Delco-Remy | 47 | 204-170 | 1-2481-01HI | PIC | 67 |
| 1998537 | 2-1493-DR | Delco-Remy | 47 | 204-197 | 1-2475-01HI | PIC | 65 |
| 1998547 | 2-1604-DR | Delco-Remy | 48 | 204-203 | 1-2315-01 | PIC | 68 |
| 1998557 | 2-1592-DR | Delco-Remy | 47 | 204-204 | 1-2474-01HI | PIC | 67 |
| 1998558 | 2-1604-DR | Delco-Remy | 48 | 204-205 | 1-2313-01HI | PIC | 66 |
| 1998560 | 2-1607-DR | Delco-Remy | 48 | 204-206 | 1-2473-01HI | PIC | 67 |
| 1998561 | 2-1604-DR | Delco-Remy | 48 | 204-207 | 1-2472-01HI | PIC | 67 |
| 1998562 | 2-1604-DR | Delco-Remy | 48 | 204-208 | 1-2471-01HI | PIC | 67 |
| 1998564 | 2-1592-DR | Delco-Remy | 47 | 204-208A | 1-2471-01HI | PIC | 67 |
| 1998565 | 2-1607-DR | Delco-Remy | 48 | 204-211 | 1-2470-01HI | PIC | 66 |
| 1998574 | 2-1604-DR | Delco-Remy | 48 | 204-212 | 1-2495-01HI | PIC | 68 |
| 1998577 | 2-1592-DR | Delco-Remy | 47 | 204-223 | 1-2358-01HI | PIC | 66 |
| 1998579 | 2-1604-DR | Delco-Remy | 48 | 204-225 | 1-2496-01HI | PIC | 68 |
| 1998580 | 2-1592-DR | Delco-Remy | 47 | 204-321 | 1-2317-01HI | PIC | 66 |
| 1998583 | 2-1604-DR | Delco-Remy | 48 | 204-328B | 1-2482-01HI | PIC | 67 |
| 1998584 | 2-1604-DR | Delco-Remy | 48 | 204-329 | 1-2271-01HI | PIC | 65 |
| 1998588 | 2-1607-DR | Delco-Remy | 48 | 204-329A | 1-2271-01HI | PIC | 65 |
| 1998589 | 2-1607-DR | Delco-Remy | 48 | 204-330 | 1-1940-01HI | PIC | 65 |
| 1998590 | 2-1604-DR | Delco-Remy | 48 | 204-330A | 1-1940-01HI | PIC | 65 |
| 1998591 | 2-1592-DR | Delco-Remy | 47 | 204-330B | 1-1940-01HI | PIC | 65 |
| 1998592 | 2-1601-DR-2 | Delco-Remy | 48 | 205-100 | 20-9900 | PIC | 49 |
| 1998596 | 2-1598-DR-2 | Delco-Remy | 48 | 2071556 | 50-151-1 | Caterpillar | 42 |
| 1C24-11000-AA | 2-2197-FD-2 | Ford | 61 | 2071556 | 50-151-2 | Caterpillar | 42 |
| 1C2Z-11002-AA | 2-2197-FD-2 | Ford | 61 | 2071556 | 50-151-3 | Caterpillar | 42 |
| 1C3U-11000-AA | 2-2197-FD-2 | Ford | 61 | 208-166 | 1-2741-01VA | PIC | 112 |
| 1C3U-11000-AB | 2-2197-FD-2 | Ford | 61 | 208-206 | 1-2510-01VA | PIC | 112 |
| 1C3U-11000-AE | 2-2197-FD-2 | Ford | 61 | 208-380 | 1-2466-01MD | PIC | 82 |

CROSS REFERENCE

CROSS REFERENCE - REF# to CATALOG#

| Mfr. Part# | Catalog# | Mfr. Name | Pg. # | Mfr. Part# | Catalog# | Mfr. Name | Pg. # |
|------------|---------------|----------------|-------|-------------|-------------|---------------|-------|
| 208-703 | 1-2614-01VA | PIC | 112 | 220-5143 | 1-2553-01BO | PIC | 1 |
| 208-730 | 1-2602-01VA | PIC | 112 | 220-5158 | 1-2711-00BO | PIC | 2 |
| 210-126 | 20-412 | PIC | 75 | 220-5158 | 1-2711-01BO | PIC | 2 |
| 210-153 | 1-2836-11MO-2 | PIC | 75 | 220-5159 | 1-2614-01VA | PIC | 112 |
| 210-155 | 1-2836-11MO-2 | PIC | 75 | 220-5300 | 1-2547-00BO | PIC | 2 |
| 210-316 | 1-2429-00MO | PIC | 75 | 220-5301 | 1-2685-00BO | PIC | 3 |
| 210-316E | 1-2564-00LN | PIC | 75 | 220-5456 | 1-2878-01BO | PIC | 3 |
| 210-325 | 1-2532-00MO | PIC | 75 | 22756A/H | 3-1005-01LU | Lucas | 77 |
| 210-325A | 1-2665-00LN | PIC | 76 | 22758A/E | 3-1005-01LU | Lucas | 77 |
| 2135890 | 2-2753-DR-2 | Hyster | 49 | 22764 | 3-1005-01LU | Lucas | 77 |
| 214169 | 20-127-1 | Cummins | 18 | 228000-062 | 2-1526-ND | Nippondenso | 102 |
| 214318 | 20-178-1 | Cummins | 17 | 228000-100 | 2-2660-ND | Nippondenso | 109 |
| 215861 | 2-2596-DR-2 | Towmotor | 49 | 228000-102 | 2-2107-ND | Nippondenso | 105 |
| 215987 | 2-2596-DR-2 | Towmotor | 49 | 228000-104 | 2-2733-ND-2 | Nippondenso | 110 |
| 216037 | 20-501-1 | Cummins | 73 | 228000-106 | 2-2735-ND-2 | Nippondenso | 111 |
| 216038 | 20-501-1 | Cummins | 73 | 228000-107 | 2-1960-ND | Nippondenso | 104 |
| 216039 | 20-501-1 | Cummins | 73 | 228000-107 | 2-1960-ND-2 | Nippondenso | 104 |
| 216040 | 20-502-1 | Cummins | 74 | 228000-108 | 2-2107-ND | Nippondenso | 105 |
| 2180475 | 1-2614-01VA | Valeo | 112 | 228000-161 | 2-2239-ND | Nippondenso | 107 |
| 2200006 | 82-6879 | Hal dex-Barnes | 117 | 228000-180 | 2-1717-ND | Nippondenso | 102 |
| 2200023-97 | 2-2596-DR-2 | Yale | 49 | 228000-188 | 2-2655-ND | Nippondenso | 109 |
| 2200071-43 | 2-2753-DR-2 | Yale | 49 | 228000-189 | 2-2099-ND | Nippondenso | 105 |
| 2200072 | 82-6869 | Hal dex-Barnes | 115 | 228000-195 | 2-1526-ND | Nippondenso | 102 |
| 2200072 | 82-6869-1 | Hal dex-Barnes | 115 | 228000-236 | 2-2279-ND | Nippondenso | 101 |
| 2200072 | 82-6874 | Hal dex-Barnes | 116 | 228000-237 | 2-2043-ND | Nippondenso | 100 |
| 2200072-52 | 2-2596-DR-2 | Yale | 49 | 228000-297 | 2-2732-ND-2 | Nippondenso | 110 |
| 2200073-59 | 2-2596-DR-2 | Yale | 49 | 228000-339 | 2-1807-ND-2 | Nippondenso | 104 |
| 2200074-00 | 1-2475-01HI | Yale | 65 | 228000-340 | 2-1822-ND | Nippondenso | 104 |
| 2200218 | 82-6879 | Hal dex-Barnes | 117 | 228000-371 | 2-2784-ND-2 | Nippondenso | 111 |
| 2200478 | 82-6854 | Hal dex-Barnes | 113 | 228000-460 | 2-2279-ND | Nippondenso | 101 |
| 2200478 | 82-6854-1 | Hal dex-Barnes | 113 | 228000-467 | 2-1526-ND | Nippondenso | 102 |
| 2200654 | 82-6873 | Hal dex-Barnes | 116 | 228000-492 | 2-2107-ND | Nippondenso | 105 |
| 2200709-79 | 2-1728-MI | Yale | 85 | 228000-512 | 2-2732-ND-2 | Nippondenso | 110 |
| 2200727 | 82-6854 | Hal dex-Barnes | 113 | 228000-536 | 2-2280-ND | Nippondenso | 101 |
| 2200727 | 82-6854-1 | Hal dex-Barnes | 113 | 228000-562 | 2-2666 | Nippondenso | 109 |
| 2200776 | 82-6854 | Hal dex-Barnes | 113 | 228000-586 | 2-2203-ND | Nippondenso | 106 |
| 2200776 | 82-6854-1 | Hal dex-Barnes | 113 | 228000-632 | 2-2656-ND | Nippondenso | 109 |
| 2200794 | 82-6880 | Hal dex-Barnes | 117 | 228000-647 | 2-1750-ND | Nippondenso | 103 |
| 2200820 | 82-6854 | Hal dex-Barnes | 113 | 228000-653 | 2-2726-ND-2 | Nippondenso | 110 |
| 2200820 | 82-6854-1 | Hal dex-Barnes | 113 | 228000-742 | 2-1981-ND-2 | Nippondenso | 104 |
| 2200849 | 82-6854 | Hal dex-Barnes | 113 | 228000-743 | 2-1983-ND | Nippondenso | 104 |
| 2200849 | 82-6854-1 | Hal dex-Barnes | 113 | 228000-787 | 2-2726-ND-2 | Nippondenso | 110 |
| 2200856 | 82-6878 | Hal dex-Barnes | 119 | 228000-804 | 2-2099-ND | Nippondenso | 105 |
| 2200949 | 82-6880 | Hal dex-Barnes | 117 | 228000-842 | 2-2197-ND | Nippondenso | 106 |
| 2200972 | 82-6886 | Hal dex-Barnes | 119 | 228000-844 | 2-2072-ND | Nippondenso | 104 |
| 2200975 | 82-6863 | Hal dex-Barnes | 115 | 228000-851 | 2-2356-ND-1 | Nippondenso | 108 |
| 220-343 | 1-2344-00BO | PIC | 2 | 2300J | 20-501-1 | Leece-Neville | 73 |
| 220-345 | 1-2237-00BO | PIC | 2 | 23099-R8103 | 1-2481-01HI | Nissan | 67 |
| 220-345A | 1-2237-00BO | PIC | 2 | 23099-R8109 | 1-2481-01HI | Nissan | 67 |
| 220-347 | 1-2711-00BO | PIC | 2 | 23100-50K10 | 1-2062-01MI | Nissan | 84 |
| 220-347 | 1-2711-01BO | PIC | 2 | 23100-51H00 | 1-2474-01HI | Nissan | 67 |
| 220-348 | 1-2435-01BO | PIC | 73 | 23100-90060 | 1-1111-02HI | Nissan | 64 |
| 220-348A | 1-2435-01BO | PIC | 73 | 23100-90065 | 1-1111-02HI | Nissan | 64 |
| 220-371 | 1-2045-01BO-2 | PIC | 2 | 23100-95013 | 1-2317-01HI | Nissan | 66 |
| 220-477 | 1-2754-02LU | PIC | 77 | 23100-B9800 | 1-1112-01 | Nissan | 65 |
| 220-498A | 1-2754-02LU | PIC | 77 | 23100-B9801 | 1-1112-01 | Nissan | 65 |
| 220-5082 | 1-2541-01BO | PIC | 1 | 23100-B9802 | 1-1112-01 | Nissan | 65 |
| 220-5093 | 1-2227-01ND | PIC | 96 | 23100-B9805 | 1-1112-01 | Nissan | 65 |
| 220-5094 | 1-2225-01BO | PIC | 1 | 23100-B9810 | 1-1112-01 | Nissan | 65 |
| 220-5095 | 1-2227-02BO | PIC | 1 | 23100-L1802 | 1-1111-02HI | Nissan | 64 |
| 220-5096 | 1-2227-02BO | PIC | 1 | 23100-L6001 | 1-2475-01HI | Nissan | 65 |
| 220-5098 | 1-2526-01BO-2 | PIC | 1 | 2314322 | 2-1728-MI-3 | Hyster | 92 |
| 220-5099 | 1-2553-01BO | PIC | 1 | 23300-00H10 | 2-1740-MI | Nissan | 86 |
| 220-5110 | 1-2510-01BO | PIC | 2 | 23300-00H11 | 2-1740-MI | Nissan | 86 |
| 220-5110 | 1-2510-01VA | PIC | 112 | 23300-05D00 | 2-2319-HI | Nissan | 72 |
| 220-5132 | 1-2852-01BO | PIC | 3 | 23300-05D01 | 2-2319-HI | Nissan | 72 |
| 220-5136 | 1-2768-01BO | PIC | 3 | 23300-06J01 | 2-2321-HI | Nissan | 72 |
| 220-5136B | 1-2768-01BO | PIC | 3 | 23300-06J02 | 2-2321-HI | Nissan | 72 |
| 220-5136C | 1-2768-01BO | PIC | 3 | 23300-06J04 | 2-2321-HI | Nissan | 72 |
| 220-5138 | 1-2589-01BO | PIC | 3 | 23300-09601 | 2-1724-HI-1 | Nissan | 68 |
| 220-5138A | 1-2589-01BO | PIC | 3 | 23300-10G02 | 2-2014-HI | Nissan | 70 |
| 220-5140 | 1-2877-01BO | PIC | 1 | 23300-10T01 | 2-2235-HI | Nissan | 71 |

CROSS REFERENCE

CROSS REFERENCE - REF# to CATALOG#

| Mfr. Part No. | Catalog No. | Mfr. Name | Pg. # | Mfr. Part No. | Catalog No. | Mfr. Name | Pg. # |
|---------------|-------------|-----------|-------|---------------|---------------|-----------|-------|
| 23300-15800 | 2-1741-1 | Nissan | 86 | 240-200 | 20-102-5 | PIC | 10 |
| 23300-15805 | 2-1741-1 | Nissan | 86 | 240-200-0A | 20-102-1 | PIC | 10 |
| 23300-15811 | 2-1741-1 | Nissan | 86 | 240-200-0C | 20-102-1 | PIC | 10 |
| 23300-15815 | 2-1741-1 | Nissan | 86 | 240-200-3 | 20-102-1 | PIC | 10 |
| 23300-20H00 | 2-1733-MI | Nissan | 88 | 240-200-3 | 20-102-5 | PIC | 10 |
| 23300-20H12 | 2-1733-MI | Nissan | 88 | 240-200-3A | 20-102-1 | PIC | 10 |
| 23300-36900 | 2-1741-1 | Nissan | 86 | 240-200-3B | 20-102-1 | PIC | 10 |
| 23300-36901 | 2-1741-1 | Nissan | 86 | 240-200-3C | 20-102-1 | PIC | 10 |
| 23300-42L13 | 2-1740-MI | Nissan | 86 | 240-200-3D | 20-102-5 | PIC | 10 |
| 23300-47601 | 2-1724-HI-1 | Nissan | 68 | 240-200-6 | 20-102-1 | PIC | 10 |
| 23300-48300 | 2-1724-HI-1 | Nissan | 68 | 240-200-6B | 20-102-1 | PIC | 10 |
| 23300-48301 | 2-1724-HI-1 | Nissan | 68 | 240-200-6F | 20-102-1 | PIC | 10 |
| 23300-52H00 | 2-2012-HI | Nissan | 70 | 240-200-9 | 20-102-1 | PIC | 10 |
| 23300-80G00 | 2-2235-HI | Nissan | 71 | 240-200-9A | 20-102-1 | PIC | 10 |
| 23300-83W00 | 2-2014-HI | Nissan | 70 | 240-200-9H | 20-102-1 | PIC | 10 |
| 23300-96504 | 2-2226-ND | Nissan | 107 | 240-200-9J | 20-102-1 | PIC | 10 |
| 23300-B0700 | 2-1724-HI-1 | Nissan | 68 | 240-200-9L | 20-102-1 | PIC | 10 |
| 23300-C0600 | 2-1736-HI-1 | Nissan | 68 | 240-200-9T | 20-102-1 | PIC | 10 |
| 23300-FU410 | 2-2698-MI | Nissan | 93 | 240-201-3 | 20-102-1 | PIC | 10 |
| 23300-K9160 | 2-1444-MI | Nissan | 92 | 240-201-3D | 20-102-5 | PIC | 10 |
| 23300-K9160 | 2-1444-MI-9 | Nissan | 92 | 240-201-3X | 20-102-1 | PIC | 10 |
| 23300-L1110 | 2-1740-MI | Nissan | 86 | 240-206 | 20-102-1 | PIC | 10 |
| 23300-L1111 | 2-1740-MI | Nissan | 86 | 240-206-0D | 20-102-1 | PIC | 10 |
| 23300-L2910 | 2-1740-MI | Nissan | 86 | 240-206-0E | 20-102-1 | PIC | 10 |
| 23300-L2911 | 2-1740-MI | Nissan | 86 | 240-206-3 | 20-102-1 | PIC | 10 |
| 23300-L2912 | 2-1740-MI | Nissan | 86 | 240-206-3A | 20-102-1 | PIC | 10 |
| 23300-L6000 | 2-2037-HI | Nissan | 70 | 240-206-3B | 20-102-1 | PIC | 10 |
| 23300-L6600 | 2-2037-HI | Nissan | 70 | 240-206-3C | 20-102-1 | PIC | 10 |
| 23300-P0614 | 2-1740-MI | Nissan | 86 | 240-206-3D | 20-102-5 | PIC | 10 |
| 23300-P5110 | 2-1741-1 | Nissan | 86 | 240-206-3E | 20-102-1 | PIC | 10 |
| 23300-P5111 | 2-1741-1 | Nissan | 86 | 240-206-3F | 20-102-1 | PIC | 10 |
| 23300-P5112 | 2-1741-1 | Nissan | 86 | 240-206-3G | 20-102-1 | PIC | 10 |
| 23300-P5113 | 2-1740-MI | Nissan | 86 | 240-206-6 | 20-102-1 | PIC | 10 |
| 23300-R9000 | 2-1740-MI | Nissan | 86 | 240-206-6B | 20-102-1 | PIC | 10 |
| 23300-T9000 | 2-2101-HI-2 | Nissan | 71 | 240-206-6F | 20-102-1 | PIC | 10 |
| 23300-T9002 | 2-2101-HI-2 | Nissan | 71 | 240-206-9 | 20-102-1 | PIC | 10 |
| 23300-T9003 | 2-2101-HI-2 | Nissan | 71 | 240-206-9A | 20-102-1 | PIC | 10 |
| 23300-T9005 | 2-2101-MI | Nissan | 90 | 240-206-9H | 20-102-1 | PIC | 10 |
| 23300-T9006 | 2-2101-MI | Nissan | 90 | 240-206-9J | 20-102-1 | PIC | 10 |
| 23300-T9007 | 2-2101-MI | Nissan | 90 | 240-206-9K | 20-102-1 | PIC | 10 |
| 23300-W9810 | 2-1444-MI | Nissan | 92 | 240-210 | 20-104-1 | PIC | 10 |
| 23300-W9810 | 2-1444-MI-9 | Nissan | 92 | 240-210-3 | 20-104-1 | PIC | 10 |
| 23300-Z5000 | 2-2037-HI | Nissan | 70 | 240-211 | 20-104-1 | PIC | 10 |
| 23300-Z5005 | 2-2037-HI | Nissan | 70 | 240-211-3 | 20-104-1 | PIC | 10 |
| 23300-Z5505 | 2-2037-HI | Nissan | 70 | 240-215 | 20-104-1 | PIC | 10 |
| 23300-Z5507 | 2-2037-HI | Nissan | 70 | 240-216 | 20-104-1 | PIC | 10 |
| 23300-Z5515 | 2-2037-HI | Nissan | 70 | 240-217 | 20-104-1 | PIC | 10 |
| 2355693 | 2-2596-DR-2 | Clark | 49 | 240-217-3 | 20-104-1 | PIC | 10 |
| 2355694 | 2-2596-DR-2 | Clark | 49 | 240-218 | 20-104-1 | PIC | 10 |
| 2355695 | 2-1750-ND | Clark | 103 | 240-219 | 20-104-1 | PIC | 10 |
| 23618A/E | 1-2619-01LU | Lucas | 76 | 240-247 | 20-113-1 | PIC | 10 |
| 23673A/B | 1-2619-01LU | Lucas | 76 | 240-247-6 | 20-113-1 | PIC | 10 |
| 23683 | 1-2619-01LU | Lucas | 76 | 240-248 | 20-113-1 | PIC | 10 |
| 23720 | 1-2619-01LU | Lucas | 76 | 240-250 | 1-2410-11DR | PIC | 9 |
| 23738A/D | 1-2619-01LU | Lucas | 76 | 240-250 | 1-2410-11DR-1 | PIC | 9 |
| 2373A029 | 2-2340-LU | Perkins | 81 | 240-251 | 1-2720-11DR-2 | PIC | 10 |
| 2373A029 | 2-2340-LU-1 | Perkins | 81 | 240-308 | 20-110-2 | PIC | 10 |
| 23760A/D | 1-2619-01LU | Lucas | 76 | 240-308-0C | 20-110-2 | PIC | 10 |
| 2377360 | 2-2596-DR-2 | Clark | 49 | 240-308-0D | 20-110-2 | PIC | 10 |
| 2378A029 | 2-2340-LU | Perkins | 81 | 240-308-0E | 20-110-2 | PIC | 10 |
| 2378A029 | 2-2340-LU-1 | Perkins | 81 | 240-308-0P | 20-110-2 | PIC | 10 |
| 23809A/B | 1-2619-01LU | Lucas | 76 | 240-308-0Q | 20-110-2 | PIC | 10 |
| 23810A/B | 1-2619-01LU | Lucas | 76 | 240-308-3 | 20-110-2 | PIC | 10 |
| 23828A/D | 1-2619-01LU | Lucas | 76 | 240-308-3D | 20-110-2 | PIC | 10 |
| 23857 | 1-2619-01LU | Lucas | 76 | 240-308-3E | 20-110-2 | PIC | 10 |
| 23905A | 1-2619-01LU | Lucas | 76 | 240-308-3F | 20-110-2 | PIC | 10 |
| 23906A | 1-2619-01LU | Lucas | 76 | 240-308-6 | 20-110-2 | PIC | 10 |
| 23948A | 1-2619-01LU | Lucas | 76 | 240-308-6F | 20-110-2 | PIC | 10 |
| 23949A | 1-2619-01LU | Lucas | 76 | 240-308-6R | 20-110-2 | PIC | 10 |
| 23950A | 1-2619-01LU | Lucas | 76 | 240-308-9 | 20-110-2 | PIC | 10 |
| 240-122 | 20-101-1 | PIC | 9 | 240-308-9A | 20-110-2 | PIC | 10 |
| 240-200 | 20-102-1 | PIC | 10 | 240-308-9E | 20-110-2 | PIC | 10 |

CROSS REFERENCE

CROSS REFERENCE - REF# to CATALOG#

| Mfr. Part# | Catalog# | Mfr. Name | Pg. # | Mfr. Part# | Catalog# | Mfr. Name | Pg. # |
|------------|---------------|-----------|-------|------------|---------------|-----------|-------|
| 240-308-9F | 20-110-2 | PIC | 10 | 240-514962 | 20-152-32-1 | PIC | 24 |
| 240-308-9K | 20-110-2 | PIC | 10 | 240-5150 | 20-152-32-1 | PIC | 24 |
| 240-308-9S | 20-110-2 | PIC | 10 | 240-515052 | 20-152-31-1 | PIC | 24 |
| 240-308-9T | 20-110-2 | PIC | 10 | 240-5151 | 20-152-11-1 | PIC | 23 |
| 240-318 | 20-116-1 | PIC | 10 | 240-5152 | 20-152-22-1 | PIC | 23 |
| 240-318-OK | 20-116-1 | PIC | 10 | 240-5153 | 20-1142-31-1 | PIC | 25 |
| 2403887 | 50-9115 | KHD | 7 | 240-5154 | 20-1142-31-1 | PIC | 25 |
| 240-4002 | 1-2427-30DR | PIC | 11 | 240-5154A | 20-1142-31-1 | PIC | 25 |
| 240-4002A | 1-2427-30DR | PIC | 11 | 240-5162 | 20-184-32 | PIC | 24 |
| 240-4002E | 1-2427-30DR | PIC | 11 | 240-5162A | 20-184-32 | PIC | 24 |
| 240-4005A | 1-2154-00DR | PIC | 15 | 240-5163 | 20-184-32 | PIC | 24 |
| 240-4005B | 1-2154-00DR | PIC | 15 | 240-5165 | 20-189-11-1 | PIC | 24 |
| 240-4007B | 1-2431-00DR-3 | PIC | 15 | 240-5180 | 20-189-11-1 | PIC | 24 |
| 240-4008 | 1-2280-00DR | PIC | 15 | 240-5185 | 20-189-11-1 | PIC | 24 |
| 240-4008B | 1-2280-00DR | PIC | 15 | 240-5391 | 20-1156-21 | PIC | 28 |
| 240-4008C | 1-2280-00DR | PIC | 15 | 240-5392 | 20-1156-21 | PIC | 28 |
| 240-4012A | 1-2044-00DR | PIC | 14 | 240-5393 | 1-2037-21DR | PIC | 27 |
| 240-4015A | 1-2065-00DR | PIC | 15 | 240-5424 | 20-175-11 | PIC | 27 |
| 240-4015A | 1-2065-00DR-3 | PIC | 15 | 240-542452 | 20-175-11 | PIC | 27 |
| 240-4017 | 1-2065-00DR | PIC | 15 | 240-5471 | 20-1105-41 | PIC | 28 |
| 240-4017 | 1-2065-00DR-3 | PIC | 15 | 240-5480 | 20-175-11 | PIC | 27 |
| 240-4017A | 1-2065-00DR | PIC | 15 | 240-5481 | 20-175-11 | PIC | 27 |
| 240-4017A | 1-2065-00DR-3 | PIC | 15 | 240-5486 | 20-1105-41 | PIC | 28 |
| 240-4020 | 1-2428-00DR-3 | PIC | 15 | 240-5490 | 1-2037-21DR | PIC | 27 |
| 240-4022 | 1-2428-00DR-3 | PIC | 15 | 240-6036 | 20-145-21-1 | PIC | 23 |
| 240-4035 | 1-2571-00DR | PIC | 16 | 240-6040 | 20-145-21-1 | PIC | 23 |
| 240-4036 | 1-2571-00DR | PIC | 16 | 240-6041 | 20-145-21-1 | PIC | 23 |
| 240-4046 | 1-2662-00DR | PIC | 16 | 240-6046 | 20-142-11-1 | PIC | 22 |
| 240-4047 | 1-2663-00DR | PIC | 16 | 240-6048 | 20-142-11-1 | PIC | 22 |
| 240-4050 | 1-2060-00DR-1 | PIC | 20 | 240-6134 | 1-1995-22DR | PIC | 26 |
| 240-4051 | 1-2078-00DR-1 | PIC | 20 | 240-6146 | 1-2175-31DR-1 | PIC | 27 |
| 240-4053 | 1-2304-00DR-1 | PIC | 20 | 240-6165 | 1-1802-31DR-1 | PIC | 26 |
| 240-4054 | 1-2680-00DR | PIC | 20 | 240-6166 | 1-1802-42DR-1 | PIC | 26 |
| 240-4070 | 1-2570-00DR | PIC | 16 | 240-6168 | 1-1802-21DR-1 | PIC | 25 |
| 240-4093B | 1-2563-00DR | PIC | 21 | 240-6172 | 1-1802-42DR-1 | PIC | 26 |
| 240-4093C | 1-2563-00DR | PIC | 21 | 240-6174 | 1-1995-21DR-1 | PIC | 26 |
| 240-4099C | 1-2561-00DR | PIC | 20 | 240-6174A | 1-1995-21DR-1 | PIC | 26 |
| 240-4103C | 1-2562-00DR | PIC | 21 | 240-6175 | 1-1995-21DR-1 | PIC | 26 |
| 240-4118 | 1-2682-00DR | PIC | 21 | 240-6177 | 1-2042-21DR-1 | PIC | 26 |
| 240-5032 | 20-145-21-1 | PIC | 23 | 240-6179 | 1-2156-21DR-1 | PIC | 26 |
| 240-5032A | 20-1132-22-1 | PIC | 25 | 240-6179A | 1-2156-21DR-1 | PIC | 26 |
| 240-5034 | 20-145-31-1 | PIC | 23 | 240-6181 | 1-2398-11DR | PIC | 27 |
| 240-503560 | 20-1132-33-1 | PIC | 25 | 240-6212 | 1-2415-41DR | PIC | 22 |
| 240-503565 | 20-1132-33-1 | PIC | 25 | 240-6213 | 1-2415-41DR | PIC | 22 |
| 240-503566 | 20-1132-33-1 | PIC | 25 | 240-6223A | 1-2419-21DR | PIC | 22 |
| 240-5036 | 20-145-21-1 | PIC | 23 | 240-6223B | 1-2556-21DR | PIC | 28 |
| 240-5036A | 20-1132-22-1 | PIC | 25 | 240-6223D | 1-2928-01DR | PIC | 28 |
| 240-5037 | 20-145-11-1 | PIC | 23 | 240-6225 | 1-2320-21DR | PIC | 21 |
| 240-5037A | 20-1132-12-1 | PIC | 24 | 240-6311 | 1-2489-01DR | PIC | 9 |
| 240-5037B | 20-145-11-1 | PIC | 23 | 240-6312 | 1-2488-01DR | PIC | 9 |
| 240-5037C | 20-1132-12-1 | PIC | 24 | 240-6410 | 1-2419-21DR | PIC | 22 |
| 240-5038 | 20-145-11-1 | PIC | 23 | 240-6410A | 1-2419-21DR | PIC | 22 |
| 240-503942 | 20-145-31-1 | PIC | 23 | 240-6410B | 1-2419-21DR | PIC | 22 |
| 240-5040 | 20-145-21-1 | PIC | 23 | 240-6413 | 1-2418-41DR | PIC | 22 |
| 240-504264 | 20-142-32-1 | PIC | 22 | 240-6415 | 1-2197-21DR | PIC | 21 |
| 240-5044 | 20-142-11-1 | PIC | 22 | 240-6415A | 1-2320-21DR | PIC | 21 |
| 240-504564 | 20-142-32-1 | PIC | 22 | 240-6415B | 1-2320-21DR | PIC | 21 |
| 240-5046 | 20-142-11-1 | PIC | 22 | 240-6417 | 1-2320-21DR | PIC | 21 |
| 240-504660 | 20-142-11-1 | PIC | 22 | 240-6418 | 1-2419-21DR | PIC | 22 |
| 240-5135 | 20-1138-11-1 | PIC | 25 | 24066A | 1-2619-01LU | Lucas | 76 |
| 240-5140 | 20-152-22-1 | PIC | 23 | 240-750 | 1-2077-00DR-1 | PIC | 19 |
| 240-514054 | 20-152-22-1 | PIC | 23 | 240-750A | 1-2077-00DR-1 | PIC | 19 |
| 240-5140A | 20-152-22-1 | PIC | 23 | 240-752 | 1-2057-00DR-1 | PIC | 19 |
| 240-5141 | 20-152-11-1 | PIC | 23 | 240-752A | 1-2057-00DR-1 | PIC | 19 |
| 240-5142 | 20-152-11-1 | PIC | 23 | 240-754 | 1-2558-00DR-1 | PIC | 19 |
| 240-5144 | 20-152-31-1 | PIC | 24 | 240-780 | 20-119-1 | PIC | 16 |
| 240-5145 | 20-152-22-1 | PIC | 23 | 240-787 | 1-2301-00DR | PIC | 17 |
| 240-514554 | 20-152-22-1 | PIC | 23 | 240-788 | 1-2301-00DR | PIC | 17 |
| 240-5145A | 20-152-22-1 | PIC | 23 | 240-800 | 20-124-1 | PIC | 17 |
| 240-5146 | 20-152-11-1 | PIC | 23 | 240-800A | 20-124-1 | PIC | 17 |
| 240-5147 | 20-152-31-1 | PIC | 24 | 240-801 | 20-126-1 | PIC | 18 |
| 240-514952 | 20-152-31-1 | PIC | 24 | 240-801A | 20-126-1 | PIC | 18 |

CROSS REFERENCE - REF# to CATALOG#

| Mfr. Part No. | Catalog No. | Mfr. Name | Pg. # | Mfr. Part No. | Catalog No. | Mfr. Name | Pg. # |
|---------------|---------------|-----------|-------|---------------|---------------|---------------|-------|
| 240-801B | 20-126-1 | PIC | 18 | 240-866A | 1-2291-00DR | PIC | 12 |
| 240-803 | 20-127-1 | PIC | 18 | 240-866B | 20-127-1 | PIC | 18 |
| 240-805 | 20-125-1 | PIC | 17 | 240-868 | 1-2292-00DR | PIC | 12 |
| 240-812 | 20-119-1 | PIC | 16 | 240-870 | 1-2334-00DR | PIC | 14 |
| 240-812C | 20-119-1 | PIC | 16 | 240-870 | 1-2334-00DR-3 | PIC | 14 |
| 240-815 | 20-121-1 | PIC | 16 | 240-870A | 1-2334-00DR | PIC | 14 |
| 240-816 | 20-178-1 | PIC | 17 | 240-870A | 1-2334-00DR-3 | PIC | 14 |
| 240-816A | 20-178-1 | PIC | 17 | 240-872 | 1-2334-00DR | PIC | 14 |
| 240-817B | 1-2301-00DR | PIC | 17 | 240-872 | 1-2334-00DR-3 | PIC | 14 |
| 240-819 | 20-1163-1 | PIC | 19 | 240-872A | 1-2334-00DR | PIC | 14 |
| 240-819A | 20-1163-1 | PIC | 19 | 240-872A | 1-2334-00DR-3 | PIC | 14 |
| 240-819C | 20-1163-1 | PIC | 19 | 240-874 | 1-2299-00DR | PIC | 13 |
| 240-820 | 20-131-1 | PIC | 18 | 240-874A | 1-2299-00DR | PIC | 13 |
| 240-820B | 20-131-1 | PIC | 18 | 240-875 | 1-2299-00DR | PIC | 13 |
| 240-821 | 20-133-1 | PIC | 18 | 240-878 | 1-1915-00DR | PIC | 11 |
| 240-825 | 20-132-1 | PIC | 18 | 240-878A | 1-1915-00DR | PIC | 11 |
| 240-825A | 20-132-1 | PIC | 18 | 240-879 | 1-2333-00DR | PIC | 14 |
| 240-834 | 20-117-1 | PIC | 11 | 240-880 | 1-1915-00DR | PIC | 11 |
| 240-835 | 20-118-1 | PIC | 11 | 240-880A | 1-1915-00DR | PIC | 11 |
| 240-835A | 20-118-1 | PIC | 11 | 240-887 | 1-1915-00DR | PIC | 11 |
| 240-836 | 20-117-1 | PIC | 11 | 240-888 | 1-1918-00DR | PIC | 12 |
| 240-837 | 1-1915-00DR | PIC | 11 | 240-889 | 1-2299-00DR | PIC | 13 |
| 240-837A | 1-1915-00DR | PIC | 11 | 240-891 | 1-2299-00DR | PIC | 13 |
| 240-837B | 1-1915-00DR | PIC | 11 | 240-899 | 1-2678-00DR | PIC | 19 |
| 240-838 | 1-2333-00DR | PIC | 14 | 24114A/F | 1-2619-01LU | Lucas | 76 |
| 240-839 | 1-1916-00DR | PIC | 12 | 24145A/D | 1-2754-02LU | Lucas | 77 |
| 240-839A | 1-1916-00DR | PIC | 12 | 24157A | 1-2762-01LU | Lucas | 77 |
| 240-839B | 1-1916-00DR | PIC | 12 | 24158B/D | 1-2621-01LU-2 | Lucas | 76 |
| 240-840 | 1-2333-00DR | PIC | 14 | 24161A | 1-2754-02LU | Lucas | 77 |
| 240-840A | 1-2300-00DR | PIC | 14 | 24200A | 1-2754-02LU | Lucas | 77 |
| 240-840B | 1-1915-00DR | PIC | 11 | 24208A/B | 1-2762-01LU | Lucas | 77 |
| 240-842 | 1-2300-00DR | PIC | 14 | 24209A/B | 1-2621-01LU-2 | Lucas | 76 |
| 240-842A | 1-2300-00DR | PIC | 14 | 24245A | 1-2621-01LU-2 | Lucas | 76 |
| 240-843 | 1-1915-00DR | PIC | 11 | 24276 | 1-2762-01LU | Lucas | 77 |
| 240-844 | 1-1915-00DR | PIC | 11 | 24277 | 1-2762-01LU | Lucas | 77 |
| 240-844A | 1-1915-00DR | PIC | 11 | 24294A | 1-2621-01LU-2 | Lucas | 76 |
| 240-848 | 1-2333-00DR | PIC | 14 | 24299 | 1-2721-01LU | Lucas | 77 |
| 240-848A | 1-2297-00DR | PIC | 13 | 24406 | 1-2721-01LU | Lucas | 77 |
| 240-849 | 1-1918-00DR | PIC | 12 | 24VA137 | 1-2721-01LU | DAF | 77 |
| 240-849A | 1-1918-00DR | PIC | 12 | 250093 | 82-6869 | Maxon | 115 |
| 240-849B | 1-1918-00DR | PIC | 12 | 250093 | 82-6869-1 | Maxon | 115 |
| 240-849C | 1-1918-00DR | PIC | 12 | 250093 | 82-6874 | Maxon | 116 |
| 240-849D | 1-1918-00DR | PIC | 12 | 2500J | 20-501-1 | Leece-Neville | 73 |
| 240-850 | 1-1915-00DR | PIC | 11 | 250-100 | 20-202 | PIC | 49 |
| 240-850A | 1-1918-00DR | PIC | 12 | 250-101 | 20-202 | PIC | 49 |
| 240-850B | 1-1918-00DR | PIC | 12 | 250-109 | 20-202 | PIC | 49 |
| 240-850C | 1-1918-00DR | PIC | 12 | 250-109A | 20-202 | PIC | 49 |
| 240-850D | 1-1918-00DR | PIC | 12 | 250-109B | 20-202 | PIC | 49 |
| 240-851 | 1-2333-00DR | PIC | 14 | 250-109C | 20-202 | PIC | 49 |
| 240-852 | 1-2333-00DR | PIC | 14 | 250-109D | 20-202 | PIC | 49 |
| 240-854 | 1-2333-00DR | PIC | 14 | 250-109E | 20-202 | PIC | 49 |
| 240-854A | 1-1915-00DR | PIC | 11 | 250-110 | 20-202 | PIC | 49 |
| 240-856 | 1-1917-00DR | PIC | 12 | 250-110A | 20-202 | PIC | 49 |
| 240-856A | 1-1917-00DR | PIC | 12 | 250-110B | 20-202 | PIC | 49 |
| 240-856B | 1-1917-00DR | PIC | 12 | 250-110C | 20-202 | PIC | 49 |
| 240-858 | 1-2299-00DR | PIC | 13 | 250-110D | 20-202 | PIC | 49 |
| 240-858A | 1-2299-00DR | PIC | 13 | 250-110E | 20-202 | PIC | 49 |
| 240-859 | 1-2300-00DR | PIC | 14 | 250-110F | 20-202 | PIC | 49 |
| 240-859A | 1-2300-00DR | PIC | 14 | 250-118 | 20-210-1 | PIC | 50 |
| 240-861 | 1-2334-00DR | PIC | 14 | 250-120 | 1-1806-12FD | PIC | 49 |
| 240-861 | 1-2334-00DR-3 | PIC | 14 | 250-121 | 1-1806-12FD | PIC | 49 |
| 240-861A | 1-2334-00DR | PIC | 14 | 250-150 | 20-208-30-1 | PIC | 51 |
| 240-861A | 1-2334-00DR-3 | PIC | 14 | 250-150 | 20-216-30 | PIC | 50 |
| 240-861B | 1-2334-00DR | PIC | 14 | 250-150A | 20-208-30-1 | PIC | 51 |
| 240-861B | 1-2334-00DR-3 | PIC | 14 | 250-150A | 20-216-30 | PIC | 50 |
| 240-862 | 1-2334-00DR | PIC | 14 | 250-150B | 20-208-30-1 | PIC | 51 |
| 240-862 | 1-2334-00DR-3 | PIC | 14 | 250-150B | 20-216-30 | PIC | 50 |
| 240-864 | 1-2334-00DR | PIC | 14 | 250-150C | 20-208-30-1 | PIC | 51 |
| 240-864 | 1-2334-00DR-3 | PIC | 14 | 250-150C | 20-216-30 | PIC | 50 |
| 240-865 | 1-2291-00DR | PIC | 12 | 250-150D | 20-208-30-1 | PIC | 51 |
| 240-865A | 1-2291-00DR | PIC | 12 | 250-150D | 20-216-30 | PIC | 50 |
| 240-866 | 1-2291-00DR | PIC | 12 | 250-151 | 20-216-10 | PIC | 50 |

CROSS REFERENCE

CROSS REFERENCE - REF# to CATALOG#

| Mfr. Part# | Catalog# | Mfr. Name | Pg. # | Mfr. Part# | Catalog# | Mfr. Name | Pg. # |
|------------|-------------|-----------|-------|-------------|---------------|----------------|-------|
| 250-151A | 20-216-10 | PIC | 50 | 250-215 | 20-226-11-2 | PIC | 53 |
| 250-151B | 20-216-10 | PIC | 50 | 250-216 | 20-226-10-2 | PIC | 53 |
| 250-151C | 20-216-10 | PIC | 50 | 250-216 | 20-226-13-2 | PIC | 53 |
| 250-155 | 20-216-10 | PIC | 50 | 250-217 | 20-226-12-2 | PIC | 53 |
| 250-155A | 20-216-10 | PIC | 50 | 250-219 | 20-239-30-2 | PIC | 56 |
| 250-157 | 20-208-30-1 | PIC | 51 | 250-219 | 20-239-31-2 | PIC | 56 |
| 250-157 | 20-216-10 | PIC | 50 | 250-219A | 20-239-31-2 | PIC | 56 |
| 250-157 | 20-216-30 | PIC | 50 | 250-220 | 20-227-30-2 | PIC | 54 |
| 250-157A | 20-208-30-1 | PIC | 51 | 250-221 | 20-227-30-2 | PIC | 54 |
| 250-157A | 20-216-30 | PIC | 50 | 250-222 | 1-1612-33FD-2 | PIC | 52 |
| 250-158 | 20-208-30-1 | PIC | 51 | 250-234 | 20-244-30-2 | PIC | 56 |
| 250-158 | 20-216-10 | PIC | 50 | 250-234 | 20-244-31-2 | PIC | 57 |
| 250-158 | 20-216-30 | PIC | 50 | 250-244 | 20-228-14-2 | PIC | 55 |
| 250-160 | 20-207-30-1 | PIC | 51 | 250-245 | 20-228-10-2 | PIC | 54 |
| 250-160 | 20-220-30 | PIC | 51 | 250-245 | 20-228-11-2 | PIC | 54 |
| 250-160A | 20-207-30-1 | PIC | 51 | 250-245A | 20-228-10-2 | PIC | 54 |
| 250-160A | 20-220-30 | PIC | 51 | 250-245A | 20-228-12-2 | PIC | 54 |
| 250-160B | 20-207-30-1 | PIC | 51 | 250-245B | 20-228-13-2 | PIC | 54 |
| 250-160B | 20-220-30 | PIC | 51 | 250-249 | 20-239-30-2 | PIC | 56 |
| 250-160D | 20-207-30-1 | PIC | 51 | 250-249 | 20-239-32-2 | PIC | 56 |
| 250-160D | 20-220-30 | PIC | 51 | 250-251 | 20-232-10-2 | PIC | 56 |
| 250-160E | 20-207-30-1 | PIC | 51 | 250-251 | 20-232-11-2 | PIC | 56 |
| 250-160E | 20-220-30 | PIC | 51 | 250-252 | 20-229-31-2 | PIC | 55 |
| 250-161 | 20-220-10 | PIC | 51 | 250-255 | 20-227-30-2 | PIC | 54 |
| 250-161F | 20-207-30-1 | PIC | 51 | 250-260 | 20-229-12-2 | PIC | 55 |
| 250-161F | 20-220-30 | PIC | 51 | 250-261 | 1-1997-11FD-2 | PIC | 52 |
| 250-165B | 20-207-30-1 | PIC | 51 | 250-262 | 20-229-14-2 | PIC | 55 |
| 250-165B | 20-220-30 | PIC | 51 | 250-263 | 20-229-10-2 | PIC | 55 |
| 250-165E | 20-207-30-1 | PIC | 51 | 250-263 | 20-229-11-2 | PIC | 55 |
| 250-165E | 20-220-30 | PIC | 51 | 250-264 | 20-229-31-2 | PIC | 55 |
| 250-166 | 20-207-30-1 | PIC | 51 | 250-265 | 1-1997-11FD-2 | PIC | 52 |
| 250-166 | 20-220-30 | PIC | 51 | 250-265A | 1-1997-11FD-2 | PIC | 52 |
| 250-166A | 20-207-30-1 | PIC | 51 | 250-281 | 1-2539-31FD | PIC | 59 |
| 250-166A | 20-220-30 | PIC | 51 | 250-295A | 1-2504-31FD | PIC | 58 |
| 250-166C | 20-207-30-1 | PIC | 51 | 250-295B | 1-2504-31FD | PIC | 58 |
| 250-166C | 20-220-30 | PIC | 51 | 250-305 | 20-209-9 | PIC | 50 |
| 250-166D | 20-207-30-1 | PIC | 51 | 250-310 | 20-210-1 | PIC | 50 |
| 250-166D | 20-220-30 | PIC | 51 | 250-315 | 20-210-1 | PIC | 50 |
| 250-167 | 20-207-30-1 | PIC | 51 | 250-315N | 20-210-1 | PIC | 50 |
| 250-167 | 20-207-31-2 | PIC | 50 | 250-401 | 1-2173-11FD-2 | PIC | 57 |
| 250-167 | 20-220-30 | PIC | 51 | 250-402 | 1-2209-11FD-2 | PIC | 58 |
| 250-167A | 20-207-30-1 | PIC | 51 | 250-403 | 1-2172-31FD-2 | PIC | 57 |
| 250-167A | 20-220-30 | PIC | 51 | 250-404 | 1-2178-31FD-2 | PIC | 57 |
| 250-167B | 20-207-30-1 | PIC | 51 | 250-416 | 1-2350-11FD-2 | PIC | 58 |
| 250-167B | 20-220-30 | PIC | 51 | 250-416A | 1-2350-11FD-2 | PIC | 58 |
| 250-167D | 20-207-30-1 | PIC | 51 | 250-420 | 1-2270-31FD-2 | PIC | 58 |
| 250-167D | 20-220-30 | PIC | 51 | 250-426 | 1-2511-11FD-2 | PIC | 58 |
| 250-167E | 20-207-30-1 | PIC | 51 | 250-427 | 1-2512-31FD-2 | PIC | 59 |
| 250-167E | 20-220-30 | PIC | 51 | 250-450 | 1-2531-11FD | PIC | 59 |
| 250-168 | 20-220-10 | PIC | 51 | 250-450A | 1-2531-11FD | PIC | 59 |
| 250-168B | 20-207-30-1 | PIC | 51 | 250-467 | 1-2667-31FD | PIC | 59 |
| 250-168B | 20-220-30 | PIC | 51 | 250-468 | 1-2669-31FD | PIC | 59 |
| 250-170 | 20-216-10 | PIC | 50 | 250-470 | 1-2350-11FD-2 | PIC | 58 |
| 250-175 | 20-220-10 | PIC | 51 | 25163 | 82-6885 | Western | 117 |
| 250-175A | 20-220-10 | PIC | 51 | 25163 | 82-7851 | Western | 118 |
| 250-175B | 20-220-10 | PIC | 51 | 2518070 | 1-2721-01LU | Valeo | 77 |
| 250-176 | 20-207-30-1 | PIC | 51 | 2529AB | 82-7852 | Meyer Products | 120 |
| 250-176 | 20-220-10 | PIC | 51 | 2529AC | 82-7852 | Meyer Products | 120 |
| 250-176 | 20-220-30 | PIC | 51 | 25372A | 2-2340-LU | Lucas | 81 |
| 250-176A | 20-207-30-1 | PIC | 51 | 25372A | 2-2340-LU-1 | Lucas | 81 |
| 250-176A | 20-220-30 | PIC | 51 | 25-37640 | 2-1960-ND | Carrier | 104 |
| 250-185 | 20-219-10 | PIC | 51 | 25-37640 | 2-1960-ND-2 | Carrier | 104 |
| 250-185A | 20-219-10 | PIC | 51 | 25-37725-00 | 2-1960-ND | Carrier | 104 |
| 250-200 | 20-225-11-2 | PIC | 53 | 25-37725-00 | 2-1960-ND-2 | Carrier | 104 |
| 250-202 | 20-229-31-2 | PIC | 55 | 25-38750-00 | 2-1960-ND | Carrier | 104 |
| 250-203 | 20-221-10-2 | PIC | 52 | 25-38750-00 | 2-1960-ND-2 | Carrier | 104 |
| 250-203 | 20-221-11-2 | PIC | 52 | 2541329 | 1-2614-01VA | Valeo | 112 |
| 250-203A | 20-221-10-2 | PIC | 52 | 2541725 | 1-2741-01VA | Valeo | 112 |
| 250-203A | 20-221-12-2 | PIC | 52 | 25556 | 82-6853 | Western | 120 |
| 250-203B | 20-221-10-2 | PIC | 52 | 256898 | 2-2291-LU | Allis-Chalmers | 80 |
| 250-203B | 20-221-12-2 | PIC | 52 | 256948 | 2-2291-LU | Allis-Chalmers | 80 |
| 250-215 | 20-226-10-2 | PIC | 53 | 2600J | 20-501-1 | Leece-Neville | 73 |

CROSS REFERENCE - REF# to CATALOG#

| Mfr. Part No. | Catalog No. | Mfr. Name | Pg. # | Mfr. Part No. | Catalog No. | Mfr. Name | Pg. # |
|---------------|-------------|-----------|-------|---------------|-------------|-----------|-------|
| 260-300 | 20-601 | PIC | 111 | 26304D | 2-2304-LU | Lucas | 81 |
| 260-301 | 20-601 | PIC | 111 | 26304D | 2-2304-LU-1 | Lucas | 81 |
| 260493C91 | 50-151-1 | IHC | 42 | 26316A/D | 2-2293-LU | Lucas | 80 |
| 260493C91 | 50-151-2 | IHC | 42 | 26316E/L | 2-2293-LU | Lucas | 80 |
| 260493C91 | 50-151-3 | IHC | 42 | 26323A | 2-2281-LU | Lucas | 79 |
| 26148 | 2-2301-LU | Lucas | 78 | 26323A | 2-2281-LU-1 | Lucas | 79 |
| 26154 | 2-2302-LU | Lucas | 79 | 26330 | 2-2293-LU | Lucas | 80 |
| 26154 | 2-2302-LU-1 | Lucas | 79 | 26336A/F | 2-2303-LU | Lucas | 80 |
| 26166 | 2-2295-LU | Lucas | 78 | 26336H/R | 2-2303-LU | Lucas | 80 |
| 26166 | 2-2295-LU-1 | Lucas | 78 | 26338A/B | 50-9200 | Lucas | 82 |
| 26193A/D | 50-9202 | Lucas | 79 | 26338A/B | 50-9200-1 | Lucas | 82 |
| 26196 | 2-2301-LU | Lucas | 78 | 26338A/B | 50-9200-2 | Lucas | 82 |
| 26200 | 2-2302-LU | Lucas | 79 | 26338D/F | 50-9200 | Lucas | 82 |
| 26200 | 2-2302-LU-1 | Lucas | 79 | 26338D/F | 50-9200-1 | Lucas | 82 |
| 26211A/L | 50-9200 | Lucas | 82 | 26338D/F | 50-9200-2 | Lucas | 82 |
| 26211A/L | 50-9200-1 | Lucas | 82 | 26339A/B | 50-9200 | Lucas | 82 |
| 26211A/L | 50-9200-2 | Lucas | 82 | 26339A/B | 50-9200-1 | Lucas | 82 |
| 26211M/T | 50-9200 | Lucas | 82 | 26339A/B | 50-9200-2 | Lucas | 82 |
| 26211M/T | 50-9200-1 | Lucas | 82 | 26339D/H | 50-9200 | Lucas | 82 |
| 26211M/T | 50-9200-2 | Lucas | 82 | 26339D/H | 50-9200-1 | Lucas | 82 |
| 26211U | 50-9200 | Lucas | 82 | 26339D/H | 50-9200-2 | Lucas | 82 |
| 26211U | 50-9200-1 | Lucas | 82 | 26341A/B | 2-2687-LU | Lucas | 81 |
| 26211U | 50-9200-2 | Lucas | 82 | 26341D/J | 2-2687-LU | Lucas | 81 |
| 26220A | 2-2302-LU | Lucas | 79 | 26343A/B | 2-2304-LU | Lucas | 81 |
| 26220A | 2-2302-LU-1 | Lucas | 79 | 26343A/B | 2-2304-LU-1 | Lucas | 81 |
| 26227R/V | 2-2293-LU | Lucas | 80 | 26343D/K | 2-2304-LU | Lucas | 81 |
| 26246A/L | 2-2304-LU | Lucas | 81 | 26343D/K | 2-2304-LU-1 | Lucas | 81 |
| 26246A/L | 2-2304-LU-1 | Lucas | 81 | 26345A/B | 2-2281-LU | Lucas | 79 |
| 26246M | 2-2304-LU | Lucas | 81 | 26345A/B | 2-2281-LU-1 | Lucas | 79 |
| 26246M | 2-2304-LU-1 | Lucas | 81 | 26345D/J | 2-2281-LU | Lucas | 79 |
| 26264H/K | 2-2302-LU | Lucas | 79 | 26345D/J | 2-2281-LU-1 | Lucas | 79 |
| 26264H/K | 2-2302-LU-1 | Lucas | 79 | 26351A/B | 2-2304-LU | Lucas | 81 |
| 26265J/M | 2-2687-LU | Lucas | 81 | 26351A/B | 2-2304-LU-1 | Lucas | 81 |
| 26270A/J | 2-2686-LU | Lucas | 79 | 26351D/H | 2-2304-LU | Lucas | 81 |
| 26274A/D | 2-2281-LU | Lucas | 79 | 26351D/H | 2-2304-LU-1 | Lucas | 81 |
| 26274A/D | 2-2281-LU-1 | Lucas | 79 | 26352A/B | 2-2293-LU | Lucas | 80 |
| 26274E/F | 2-2281-LU | Lucas | 79 | 26352D/K | 2-2293-LU | Lucas | 80 |
| 26274E/F | 2-2281-LU-1 | Lucas | 79 | 26357A | 2-2458-LU | Lucas | 81 |
| 26274H/N | 2-2281-LU | Lucas | 79 | 26357A | 2-2458-LU-1 | Lucas | 81 |
| 26274H/N | 2-2281-LU-1 | Lucas | 79 | 26357B/E | 2-2458-LU | Lucas | 81 |
| 26275A/E | 2-2300-LU | Lucas | 78 | 26357B/E | 2-2458-LU-1 | Lucas | 81 |
| 26275A/E | 2-2300-LU-1 | Lucas | 78 | 26358A | 2-2340-LU | Lucas | 81 |
| 26275F/K | 2-2300-LU | Lucas | 78 | 26358A | 2-2340-LU-1 | Lucas | 81 |
| 26275F/K | 2-2300-LU-1 | Lucas | 78 | 26358B/H | 2-2340-LU | Lucas | 81 |
| 26281 | 2-2300-LU | Lucas | 78 | 26358B/H | 2-2340-LU-1 | Lucas | 81 |
| 26281 | 2-2300-LU-1 | Lucas | 78 | 26363A/J | 2-2291-LU | Lucas | 80 |
| 26282 | 2-2301-LU | Lucas | 78 | 26366A/F | 2-2281-LU | Lucas | 79 |
| 26282A/D | 2-2301-LU | Lucas | 78 | 26366A/F | 2-2281-LU-1 | Lucas | 79 |
| 26283H/K | 2-2301-LU | Lucas | 78 | 26369A/H | 2-2458-LU | Lucas | 81 |
| 26286A/E | 2-2295-LU | Lucas | 78 | 26369A/H | 2-2458-LU-1 | Lucas | 81 |
| 26286A/E | 2-2295-LU-1 | Lucas | 78 | 26371A/D | 2-2296-LU | Lucas | 78 |
| 26288F/J | 50-9202 | Lucas | 79 | 26375A/D | 2-2301-LU | Lucas | 78 |
| 26291A/D | 50-9200 | Lucas | 82 | 26376A/K | 2-2304-LU | Lucas | 81 |
| 26291A/D | 50-9200-1 | Lucas | 82 | 26376A/K | 2-2304-LU-1 | Lucas | 81 |
| 26291A/D | 50-9200-2 | Lucas | 82 | 263819C91 | 50-153-1 | IHC | 43 |
| 26291E | 50-9200 | Lucas | 82 | 263819C91 | 50-153-2 | IHC | 43 |
| 26291E | 50-9200-1 | Lucas | 82 | 26395A/B | 50-9200 | Lucas | 82 |
| 26291E | 50-9200-2 | Lucas | 82 | 26395A/B | 50-9200-1 | Lucas | 82 |
| 26294A/B | 2-2458-LU | Lucas | 81 | 26395A/B | 50-9200-2 | Lucas | 82 |
| 26294A/B | 2-2458-LU-1 | Lucas | 81 | 26395A/H | 50-9200-2 | Lucas | 82 |
| 26294D/E | 2-2458-LU | Lucas | 81 | 26395D/E | 50-9200 | Lucas | 82 |
| 26294D/E | 2-2458-LU-1 | Lucas | 81 | 26395D/E | 50-9200-1 | Lucas | 82 |
| 26294F/N | 2-2458-LU | Lucas | 81 | 26395D/E | 50-9200-2 | Lucas | 82 |
| 26294F/N | 2-2458-LU-1 | Lucas | 81 | 26398A/F | 2-2282-LU | Lucas | 80 |
| 26295A/B | 2-2340-LU | Lucas | 81 | 26400A/B | 2-2296-LU | Lucas | 78 |
| 26295A/B | 2-2340-LU-1 | Lucas | 81 | 26404A/D | 2-2290-LU | Lucas | 80 |
| 26295D/E | 2-2340-LU | Lucas | 81 | 26410A/B | 2-2281-LU | Lucas | 79 |
| 26295D/E | 2-2340-LU-1 | Lucas | 81 | 26410A/B | 2-2281-LU-1 | Lucas | 79 |
| 26295F/M | 2-2340-LU | Lucas | 81 | 26411 | 2-2292-LU | Lucas | 80 |
| 26295F/M | 2-2340-LU-1 | Lucas | 81 | 26411 | 2-2292-LU-1 | Lucas | 80 |
| 26304A/B | 2-2304-LU | Lucas | 81 | 26412A | 2-2302-LU | Lucas | 79 |
| 26304A/B | 2-2304-LU-1 | Lucas | 81 | 26412A | 2-2302-LU-1 | Lucas | 79 |

CROSS REFERENCE

CROSS REFERENCE - REF# to CATALOG#

| Mfr. Part# | Catalog# | Mfr. Name | Pg. # | Mfr. Part# | Catalog# | Mfr. Name | Pg. # |
|-----------------|---------------|---------------|-------|------------|-------------|-----------|-------|
| 26413A | 2-2305-LU | Lucas | 79 | 27474 | 2-2302-LU-1 | Lucas | 79 |
| 26414A/E | 2-2340-LU | Lucas | 81 | 27475 | 2-2300-LU | Lucas | 78 |
| 26414A/E | 2-2340-LU-1 | Lucas | 81 | 27475 | 2-2300-LU-1 | Lucas | 78 |
| 26422A | 2-2301-LU | Lucas | 78 | 27478 | 2-2301-LU | Lucas | 78 |
| 26428A | 2-2303-LU | Lucas | 80 | 27479 | 2-2300-LU | Lucas | 78 |
| 26429A | 2-2291-LU | Lucas | 80 | 27479 | 2-2300-LU-1 | Lucas | 78 |
| 26431A | 2-2687-LU | Lucas | 81 | 27481 | 2-2295-LU | Lucas | 78 |
| 26433A | 2-2303-LU | Lucas | 80 | 27481 | 2-2295-LU-1 | Lucas | 78 |
| 26435A | 2-2301-LU | Lucas | 78 | 27482 | 2-2300-LU | Lucas | 78 |
| 2653016 | 1-2510-01VA | Valeo | 112 | 27482 | 2-2300-LU-1 | Lucas | 78 |
| 2670J | 20-502-1 | Leece-Neville | 74 | 27486 | 2-2301-LU | Lucas | 78 |
| 2700J | 20-502-1 | Leece-Neville | 74 | 27487 | 2-2300-LU | Lucas | 78 |
| 270-412 | 20-504-1 | PIC | 74 | 27487 | 2-2300-LU-1 | Lucas | 78 |
| 270-419 | 20-501-1 | PIC | 73 | 27489 | 2-2295-LU | Lucas | 78 |
| 270-420 | 20-501-1 | PIC | 73 | 27489 | 2-2295-LU-1 | Lucas | 78 |
| 270-420F | 20-501-1 | PIC | 73 | 27490 | 2-2300-LU | Lucas | 78 |
| 270-421 | 20-501-1 | PIC | 73 | 27490 | 2-2300-LU-1 | Lucas | 78 |
| 270-421A | 20-502-1 | PIC | 74 | 27500A/J | 50-9200 | Lucas | 82 |
| 270-422 | 20-502-1 | PIC | 74 | 27500A/J | 50-9200-1 | Lucas | 82 |
| 270-422F | 20-502-1 | PIC | 74 | 27500A/J | 50-9200-2 | Lucas | 82 |
| 270-423 | 20-504-1 | PIC | 74 | 27502 | 2-2458-LU | Lucas | 81 |
| 270-426 | 20-502-1 | PIC | 74 | 27502 | 2-2458-LU-1 | Lucas | 81 |
| 270-429 | 20-504-1 | PIC | 74 | 27508A/B | 2-2303-LU | Lucas | 80 |
| 270-441 | 1-2653-00LN | PIC | 74 | 27508A/D | 2-2303-LU | Lucas | 80 |
| 270-460 | 1-2655-00LN | PIC | 74 | 27513 | 2-2304-LU | Lucas | 81 |
| 270-460B | 1-2661-00LN | PIC | 75 | 27513 | 2-2304-LU-1 | Lucas | 81 |
| 270-471 | 1-2658-00LN | PIC | 74 | 27515A/E | 2-2281-LU | Lucas | 79 |
| 270-553A | 1-2652-00LN | PIC | 74 | 27515A/E | 2-2281-LU-1 | Lucas | 79 |
| 27060-76305 | 1-2439-01ND | Toyota | 98 | 27518A/B | 2-2458-LU | Lucas | 81 |
| 27060-78001 | 1-2119-11ND | Toyota | 98 | 27518A/B | 2-2458-LU-1 | Lucas | 81 |
| 27060-78001 | 1-2119-11ND-9 | Toyota | 98 | 27518A/E | 2-2458-LU | Lucas | 81 |
| 27060-78001-71 | 1-2119-11ND | Toyota | 98 | 27518A/E | 2-2458-LU-1 | Lucas | 81 |
| 27060-78001-71 | 1-2119-11ND-9 | Toyota | 98 | 27519A | 2-2340-LU | Lucas | 81 |
| 27060-78003-71 | 1-2132-01ND | Toyota | 98 | 27519A | 2-2340-LU-1 | Lucas | 81 |
| 27060-78003-71 | 1-2132-01ND-2 | Toyota | 98 | 27520 | 2-2458-LU | Lucas | 81 |
| 27060-78156-71 | 1-2823-01ND-2 | Toyota | 100 | 27520 | 2-2458-LU-1 | Lucas | 81 |
| 27060-78300-71 | 1-2822-01ND-2 | Toyota | 99 | 27526 | 2-2304-LU | Lucas | 81 |
| 27060-78301 | 1-1946-01ND | Toyota | 97 | 27526 | 2-2304-LU-1 | Lucas | 81 |
| 27060-78301-71 | 1-1946-01ND | Toyota | 97 | 27533A/E | 2-2282-LU | Lucas | 80 |
| 27060-78305 | 1-2439-01ND | Toyota | 98 | 27536A | 2-2290-LU | Lucas | 80 |
| 27060-78305-71 | 1-2439-01ND | Toyota | 98 | 27539A | 2-2281-LU | Lucas | 79 |
| 27060-87201 | 1-2436-01ND | Daihatsu | 98 | 27539A | 2-2281-LU-1 | Lucas | 79 |
| 27060-87211 | 1-2119-11ND | Daihatsu | 98 | 27540A | 2-2292-LU | Lucas | 80 |
| 27060-87212 | 1-2119-11ND | Toyota | 98 | 27540A | 2-2292-LU-1 | Lucas | 80 |
| 27060-87212-000 | 1-2119-11ND | Daihatsu | 98 | 27541A | 2-2340-LU | Lucas | 81 |
| 27060-87701 | 1-1946-01ND | Toyota | 97 | 27541A | 2-2340-LU-1 | Lucas | 81 |
| 27070-23001-71 | 1-2821-01ND-2 | Toyota | 99 | 27546 | 2-2292-LU | Lucas | 80 |
| 27409A/B | 2-2302-LU | Lucas | 79 | 27546 | 2-2292-LU-1 | Lucas | 80 |
| 27409A/B | 2-2302-LU-1 | Lucas | 79 | 27554A | 2-2687-LU | Lucas | 81 |
| 27410A | 2-2686-LU | Lucas | 79 | 27556A | 2-2303-LU | Lucas | 80 |
| 27411A/B | 2-2305-LU | Lucas | 79 | 27558A/B | 2-2291-LU | Lucas | 80 |
| 27412 | 2-2300-LU | Lucas | 78 | 27564K | 2-2459-LU | Lucas | 81 |
| 27412 | 2-2300-LU-1 | Lucas | 78 | 27565B/D | 2-2340-LU | Lucas | 81 |
| 27415 | 2-2300-LU | Lucas | 78 | 27565B/D | 2-2340-LU-1 | Lucas | 81 |
| 27415 | 2-2300-LU-1 | Lucas | 78 | 27565E | 2-2340-LU | Lucas | 81 |
| 27417A/B | 2-2301-LU | Lucas | 78 | 27565E | 2-2340-LU-1 | Lucas | 81 |
| 27417A/E | 2-2301-LU | Lucas | 78 | 27568A | 2-2340-LU | Lucas | 81 |
| 27419A/D | 2-2295-LU | Lucas | 78 | 27568A | 2-2340-LU-1 | Lucas | 81 |
| 27419A/D | 2-2295-LU-1 | Lucas | 78 | 27569A | 50-9200-2 | Lucas | 82 |
| 27420A/B | 50-9202 | Lucas | 79 | 27569A/B | 50-9200-2 | Lucas | 82 |
| 27431A | 2-2296-LU | Lucas | 78 | 27570 | 2-2458-LU | Lucas | 81 |
| 27433A | 2-2305-LU | Lucas | 79 | 27570 | 2-2458-LU-1 | Lucas | 81 |
| 27435A | 2-2301-LU | Lucas | 78 | 27571 | 2-2292-LU | Lucas | 80 |
| 27459 | 2-2302-LU | Lucas | 79 | 27571 | 2-2292-LU-1 | Lucas | 80 |
| 27459 | 2-2302-LU-1 | Lucas | 79 | 27572 | 2-2281-LU | Lucas | 79 |
| 27469 | 2-2302-LU | Lucas | 79 | 27572 | 2-2281-LU-1 | Lucas | 79 |
| 27469 | 2-2302-LU-1 | Lucas | 79 | 27575E | 2-2303-LU | Lucas | 80 |
| 27470 | 2-2302-LU | Lucas | 79 | 27584 | 2-2292-LU | Lucas | 80 |
| 27470 | 2-2302-LU-1 | Lucas | 79 | 27584 | 2-2292-LU-1 | Lucas | 80 |
| 27473 | 2-2300-LU | Lucas | 78 | 27586 | 2-2303-LU | Lucas | 80 |
| 27473 | 2-2300-LU-1 | Lucas | 78 | 27588 | 2-2458-LU | Lucas | 81 |
| 27474 | 2-2302-LU | Lucas | 79 | 27588 | 2-2458-LU-1 | Lucas | 81 |

CROSS REFERENCE - REF# to CATALOG#

| Mfr. Part No. | Catalog No. | Mfr. Name | Pg. # | Mfr. Part No. | Catalog No. | Mfr. Name | Pg. # |
|----------------|---------------|---------------|-------|---------------|---------------|-----------------|-------|
| 27591 | 2-2292-LU | Lucas | 80 | 284074 | 2-2753-DR-2 | Hyster | 49 |
| 27591 | 2-2292-LU-1 | Lucas | 80 | 2869AB | 82-7852 | Meyer Products | 120 |
| 27592 | 2-2458-LU | Lucas | 81 | 2871A007 | 1-2721-01LU | Perkins | 77 |
| 27592 | 2-2458-LU-1 | Lucas | 81 | 2871A101 | 1-2619-01LU | Perkins | 76 |
| 27595 | 2-2459-LU | Lucas | 81 | 2871A121 | 1-2619-01LU | Perkins | 76 |
| 27596 | 2-2458-LU | Lucas | 81 | 2871A129 | 1-2619-01LU | Perkins | 76 |
| 27596 | 2-2458-LU-1 | Lucas | 81 | 2871A156 | 1-2730-00LU | Perkins | 77 |
| 27601 | 2-2282-LU | Lucas | 80 | 2871A651 | 1-2721-01LU | Perkins | 77 |
| 27604 | 2-2303-LU | Lucas | 80 | 2873121 | 2-2301-LU | Perkins | 78 |
| 27608 | 2-2340-LU | Lucas | 81 | 2873126 | 2-2295-LU | Perkins | 78 |
| 27608 | 2-2340-LU-1 | Lucas | 81 | 2873126 | 2-2295-LU-1 | Perkins | 78 |
| 2800J | 20-504-1 | Leece-Neville | 74 | 2873153 | 2-2295-LU | Perkins | 78 |
| 280-306A | 1-2762-01LU | PIC | 77 | 2873153 | 2-2295-LU-1 | Perkins | 78 |
| 280-312 | 1-2754-02LU | PIC | 77 | 2873A031 | 2-2340-LU | Perkins | 81 |
| 280-312A | 1-2754-02LU | PIC | 77 | 2873A031 | 2-2340-LU-1 | Perkins | 81 |
| 280-312C | 1-2754-02LU | PIC | 77 | 2873B056 | 2-2458-LU | Perkins | 81 |
| 280-325 | 1-2454-01MM | PIC | 76 | 2873B056 | 2-2458-LU-1 | Perkins | 81 |
| 280-326 | 1-2455-01MM | PIC | 73 | 2873B061 | 2-2292-LU | Perkins | 80 |
| 280-326A | 1-2455-01MM | PIC | 73 | 2873B061 | 2-2292-LU-1 | Perkins | 80 |
| 280-331 | 1-2619-01LU | PIC | 76 | 2873B071 | 2-2458-LU | Perkins | 81 |
| 280-331A | 1-2619-01LU | PIC | 76 | 2873B071 | 2-2458-LU-1 | Perkins | 81 |
| 280-331B | 1-2619-01LU | PIC | 76 | 2873B072 | 2-2340-LU | Perkins | 81 |
| 280-337 | 1-2621-01LU-2 | PIC | 76 | 2873B072 | 2-2340-LU-1 | Perkins | 81 |
| 280-347 | 1-2454-01MM | PIC | 76 | 2873D001 | 2-2737-HI-2 | Massey Ferguson | 69 |
| 280-358 | 1-2721-01LU | PIC | 77 | 2873D003 | 2-2301-LU | Perkins | 78 |
| 28100-1542 | 2-2108-ND | Hino | 106 | 2873D304 | 2-2285-BO | Perkins | 4 |
| 28100-1561A | 2-2709-ND-2 | Hino | 110 | 290-109 | 1-2461-01ND | PIC | 94 |
| 28100-1562A | 2-2709-ND-2 | Hino | 110 | 290-186 | 1-2821-01ND-2 | PIC | 99 |
| 28100-1645A | 2-2224-ND | Hino | 106 | 290-193 | 1-2478-01ND | PIC | 99 |
| 28100-1670 | 2-2276-ND | Hino | 101 | 290-194 | 1-2477-01ND | PIC | 99 |
| 28100-1670A | 2-2276-ND | Hino | 101 | 290-198 | 1-2436-01ND | PIC | 98 |
| 28100-1671A | 2-2276-ND | Hino | 101 | 290-199 | 1-2336-01ND | PIC | 98 |
| 28100-1672A | 2-2276-ND | Hino | 101 | 290-199 | 1-2336-01ND-9 | PIC | 98 |
| 28100-17040 | 2-2239-ND | Toyota | 107 | 290-199A | 1-2476-01ND | PIC | 99 |
| 28100-1743A | 2-2223-ND | Hino | 106 | 290-202 | 1-2119-11ND | PIC | 98 |
| 28100-1863 | 2-2222-ND | Hino | 106 | 290-205 | 1-1946-01ND | PIC | 97 |
| 28100-1863D | 2-2222-ND | Hino | 106 | 290-206 | 1-2132-01ND | PIC | 98 |
| 28100-1900 | 2-2108-ND | Hino | 106 | 290-206 | 1-2132-01ND-2 | PIC | 98 |
| 28100-1930A | 2-2709-ND-2 | Hino | 110 | 290-207 | 1-2439-01ND | PIC | 98 |
| 28100-1931A | 2-2709-ND-2 | Hino | 110 | 290-209 | 1-2119-11ND | PIC | 98 |
| 28100-1960A | 2-2709-ND-2 | Hino | 110 | 290-209 | 1-2119-11ND-9 | PIC | 98 |
| 28100-1961 | 2-2709-ND-2 | Hino | 110 | 2-90222-002-0 | 20-142-11-1 | Isuzu | 22 |
| 28100-1961A | 2-2709-ND-2 | Hino | 110 | 290-257 | 1-1527-02ND-2 | PIC | 96 |
| 28100-22061 | 2-1754-ND | Toyota | 103 | 290-257A | 1-1527-02ND-2 | PIC | 96 |
| 28100-22061-71 | 2-1754-ND | Toyota | 103 | 290-257B | 1-1527-02ND-2 | PIC | 96 |
| 28100-23660-71 | 2-2784-ND-2 | Toyota | 111 | 290-261 | 1-1504-05ND-2 | PIC | 95 |
| 28100-31625 | 2-2106-ND | Toyota | 105 | 290-261A | 1-1504-05ND-2 | PIC | 95 |
| 28100-31625-71 | 2-2106-ND | Toyota | 105 | 290-262 | 1-1504-01ND-2 | PIC | 95 |
| 28100-360E3 | 2-1526-ND | Toyota | 102 | 290-265A | 1-1504-06ND-2 | PIC | 96 |
| 28100-36E03 | 2-1526-ND | Toyota | 102 | 290-275C | 1-1503-05ND-2 | PIC | 95 |
| 28100-40010 | 2-1682-ND | Toyota | 100 | 290-275D | 1-1503-01ND-2 | PIC | 95 |
| 28100-40011 | 2-1682-ND | Toyota | 100 | 290-275E | 1-1503-06ND-2 | PIC | 95 |
| 28100-40014 | 2-1682-ND | Toyota | 100 | 2-90276-810-0 | 1-2358-01HI | Isuzu | 66 |
| 28100-40015 | 2-1682-ND | Toyota | 100 | 290-402 | 1-2236-10ND | PIC | 97 |
| 28100-40290 | 2-2784-ND-2 | Toyota | 111 | 290-402A | 1-2236-10ND | PIC | 97 |
| 28100-40290-71 | 2-2784-ND-2 | Toyota | 111 | 290-402B | 1-2236-10ND | PIC | 97 |
| 28100-40291 | 2-2784-ND-2 | Toyota | 111 | 290-405 | 1-2851-01ND | PIC | 100 |
| 28100-40291-71 | 2-2784-ND-2 | Toyota | 111 | 290-415 | 1-2822-01ND-2 | PIC | 99 |
| 28100-47090 | 2-2106-ND | Toyota | 105 | 290-472 | 1-2823-01ND-2 | PIC | 100 |
| 28100-47090-C | 2-2106-ND | Toyota | 105 | 290-473 | 20-121-1 | PIC | 16 |
| 28100-47091 | 2-2106-ND | Toyota | 105 | 290-499 | 1-2227-01ND | PIC | 96 |
| 28100-54070 | 2-2238-ND | Toyota | 107 | 290-5103 | 1-2087-01ND-2 | PIC | 96 |
| 28100-56030 | 2-2104-ND | Toyota | 105 | 290-5104 | 1-2227-02ND-2 | PIC | 97 |
| 28100-56100 | 2-2104-ND | Toyota | 105 | 290-5104A | 1-2227-02ND-2 | PIC | 97 |
| 28100-56160 | 2-2265-ND | Toyota | 108 | 290-5106 | 1-2225-01ND-2 | PIC | 96 |
| 28100-56161 | 2-2265-ND | Toyota | 108 | 290-5125 | 1-2389-01ND-2 | PIC | 97 |
| 28100-89107 | 2-2265-ND | Toyota | 108 | 290-5126 | 1-2390-01ND | PIC | 97 |
| 282-112 | 1-2435-01BO | PIC | 73 | 290-5126A | 1-2390-01ND | PIC | 97 |
| 282-287 | 1-2455-01MM | PIC | 73 | 290-5126B | 1-2390-01ND | PIC | 97 |
| 28300-23040 | 2-2708-ND-2 | Toyota | 109 | 290-5134 | 1-2441-01ND | PIC | 97 |
| 28300-23041 | 2-2708-ND-2 | Toyota | 109 | 290-5135 | 1-2541-01BO | PIC | 1 |
| 28300-23041-71 | 2-2708-ND-2 | Toyota | 109 | 290-5241 | 1-2456-01ND | PIC | 99 |

CROSS REFERENCE

CROSS REFERENCE - REF# to CATALOG#

| Mfr. Part# | Catalog# | Mfr. Name | Pg. # | Mfr. Part# | Catalog# | Mfr. Name | Pg. # |
|---------------|---------------|----------------------|-------|------------|---------------|-----------|-------|
| 2-91255-902-0 | 2-1745-ND-1 | Isuzu | 103 | 3136101 | 2-2753-DR-2 | Hyster | 49 |
| 2-91255-914-0 | 2-1193-ND | Isuzu | 101 | 313973R93 | 50-151-1 | IHC | 42 |
| 2-91276-000-0 | 1-2271-01HI | Isuzu | 65 | 313973R93 | 50-151-2 | IHC | 42 |
| 2-91276-300-0 | 1-2495-01HI | Isuzu | 68 | 313973R93 | 50-151-3 | IHC | 42 |
| 293-12 | 1-2308-31MD | PIC | 82 | 3152 | 2-1675-FD | Lester | 61 |
| 293-19 | 1-2308-31MD | PIC | 82 | 3180 | 2-1648-FD | Lester | 60 |
| 293-19A | 1-2467-01MD | PIC | 82 | 3181A032 | 2-2340-LU | Perkins | 81 |
| 293-20 | 1-2462-31MD | PIC | 82 | 3181A032 | 2-2340-LU-1 | Perkins | 81 |
| 2994BD00355 | 82-6877 | Haldex-Barnes | 118 | 3185 | 2-1642-FD | Lester | 60 |
| 2C24-11000-AA | 2-2197-FD-2 | Ford | 61 | 3188 | 2-1649-FD | Lester | 60 |
| 2C3T-11000-AA | 2-2197-FD-2 | Ford | 61 | 3205 | 2-1806-FD-1 | Lester | 62 |
| 2C3T-11000-AB | 2-2197-FD-2 | Ford | 61 | 321-1009 | 20-1132-12-1 | AC-Delco | 24 |
| 2C3U-10300-AA | 1-2504-31FD | Ford | 58 | 321-1015 | 20-110-2 | AC-Delco | 10 |
| 2C3U-10300-AB | 1-2504-31FD | Ford | 58 | 321-1016 | 20-1132-33-1 | AC-Delco | 25 |
| 2C3U-10300-BB | 1-2511-11FD-2 | Ford | 58 | 321-1025 | 1-1802-21DR-1 | AC-Delco | 25 |
| 2C3U-10300-BC | 1-2511-11FD-2 | Ford | 58 | 321-1026 | 1-1802-31DR-1 | AC-Delco | 26 |
| 2C3U-10300-CB | 1-2512-31FD-2 | Ford | 59 | 321-1027 | 1-1802-42DR-1 | AC-Delco | 26 |
| 2C3Z-10346-AA | 1-2504-31FD | Ford | 58 | 321-1033 | 20-1132-12-1 | AC-Delco | 24 |
| 2C3Z-10346-BA | 1-2511-11FD-2 | Ford | 58 | 321-1034 | 20-152-11-1 | AC-Delco | 23 |
| 2C3Z-10346-BB | 1-2511-11FD-2 | Ford | 58 | 321-1035 | 20-1132-22-1 | AC-Delco | 25 |
| 2C3Z-10346-CA | 1-2512-31FD-2 | Ford | 59 | 321-1037 | 20-1132-33-1 | AC-Delco | 25 |
| 2C3Z-11002-AA | 2-2197-FD-2 | Ford | 61 | 321-1038 | 20-1132-12-1 | AC-Delco | 24 |
| 2L3U-10300-BB | 20-239-31-2 | Ford | 56 | 321-1039 | 20-184-32 | AC-Delco | 24 |
| 2MJ4112P2 | 20-501-1 | Mack Truck | 73 | 321-1041 | 20-1142-31-1 | AC-Delco | 25 |
| 2MJ4112P3 | 20-501-1 | Mack Truck | 73 | 321-1042 | 20-1142-31-1 | AC-Delco | 25 |
| 2MJ54 | 1-2653-00LN | Mack Truck | 74 | 321-1043 | 20-1142-31-1 | AC-Delco | 25 |
| 2N2761 | 50-153-1 | Caterpillar | 43 | 321-1044 | 20-1132-22-1 | AC-Delco | 25 |
| 2N2761 | 50-153-2 | Caterpillar | 43 | 321-1045 | 20-1132-33-1 | AC-Delco | 25 |
| 2P1204 | 20-601 | Caterpillar | 111 | 321-1051 | 1-1802-42DR-1 | AC-Delco | 26 |
| 2P1698 | 20-601 | Caterpillar | 111 | 321-1052 | 20-145-11-1 | AC-Delco | 23 |
| 2P5113 | 20-601 | Caterpillar | 111 | 321-1064 | 20-189-11-1 | AC-Delco | 24 |
| 2P7836 | 20-601 | Caterpillar | 111 | 321-1085 | 20-142-11-1 | AC-Delco | 22 |
| 2S0900 | 50-152-1 | Caterpillar | 42 | 321-1095 | 20-1156-21 | AC-Delco | 28 |
| 2S0900 | 50-152-2 | Caterpillar | 42 | 321-1100 | 1-1802-31DR-1 | AC-Delco | 26 |
| 2S7029 | 20-117-1 | Caterpillar | 11 | 321-1107 | 1-1995-21DR-1 | AC-Delco | 26 |
| 30-00331 | 20-412 | Carrier | 75 | 321-1108 | 1-1995-21DR-1 | AC-Delco | 26 |
| 3001008 | 2-2596-DR-2 | Hyster | 49 | 321-1128 | 20-1156-21 | AC-Delco | 28 |
| 3001023 | 2-2753-DR-2 | Hyster | 49 | 321-1129 | 1-2037-21DR | AC-Delco | 27 |
| 3002935 | 2-2596-DR-2 | Hyster | 49 | 321-1130 | 1-2042-21DR-1 | AC-Delco | 26 |
| 3003784 | 2-2706-MI | Hyster | 86 | 321-1132 | 1-1995-21DR-1 | AC-Delco | 26 |
| 3004017 | 2-1737-ND | Hyster | 103 | 321-1134 | 20-1156-21 | AC-Delco | 28 |
| 3004552 | 2-2596-DR-2 | Hyster | 49 | 321-1161 | 20-101-1 | AC-Delco | 9 |
| 3004568 | 2-1754-ND | Hyster | 103 | 321-134 | 20-102-1 | AC-Delco | 10 |
| 3004578 | 1-1111-02HI | Hyster | 64 | 321-135 | 20-102-1 | AC-Delco | 10 |
| 3004806 | 20-131-1 | Cummins | 18 | 321-1429 | 20-1156-21 | AC-Delco | 28 |
| 302071 | 50-161-1 | Caterpillar | 36 | 321-143 | 20-102-1 | AC-Delco | 10 |
| 3021034 | 50-153-1 | Cummins | 43 | 321-1430 | 1-2037-21DR | AC-Delco | 27 |
| 3021034 | 50-153-2 | Cummins | 43 | 321-1432 | 1-2156-21DR-1 | AC-Delco | 26 |
| 3021036 | 50-151-1 | Cummins | 42 | 321-1433 | 1-2175-31DR-1 | AC-Delco | 27 |
| 3021036 | 50-151-2 | Cummins | 42 | 321-1438 | 1-1995-22DR | AC-Delco | 26 |
| 3021036 | 50-151-3 | Cummins | 42 | 321-1439 | 1-2042-21DR-1 | AC-Delco | 26 |
| 3021367 | 2-1728-MI | Hyster | 85 | 321-148 | 20-102-1 | AC-Delco | 10 |
| 3046890R93 | 50-9202 | IHC | 79 | 321-161 | 20-101-1 | AC-Delco | 9 |
| 3046996 | 1-2475-01HI | Hyster | 65 | 321-164 | 20-101-1 | AC-Delco | 9 |
| 3049385 | 2-2293-LU | Hyster | 80 | 321-169 | 20-101-1 | AC-Delco | 9 |
| 3049491 | 1-2119-11ND | Hyster | 98 | 321-1748 | 1-2197-21DR | AC-Delco | 21 |
| 3049491 | 1-2119-11ND-9 | Hyster | 98 | 321-1749 | 1-2419-21DR | AC-Delco | 22 |
| 3068342 | 1-1960-01MI | Hyster | 84 | 321-1793 | 1-2156-21DR-1 | AC-Delco | 26 |
| 3068345 | 2-1728-MI | Hyster | 85 | 321-1798 | 1-2320-21DR | AC-Delco | 21 |
| 3068345 | 2-1728-MI-3 | Hyster | 92 | 321-1811 | 1-2320-21DR | AC-Delco | 21 |
| 3068346 | 2-2024-MI | Hyster | 89 | 321-1813 | 1-2419-21DR | AC-Delco | 22 |
| 3091293-M92 | 2-2299-BO | Massey Ferguson | 5 | 321-1815 | 1-2320-21DR | AC-Delco | 21 |
| 30966-03010 | 2-2091-MI | Mitsubishi Heavy Ind | 89 | 321-1816 | 1-2419-21DR | AC-Delco | 22 |
| 3109 | 2-2288-FD | Lester | 61 | 321-1817 | 1-1995-21DR-1 | AC-Delco | 26 |
| 3110 | 2-2289-FD | Lester | 61 | 321-1819 | 1-2415-41DR | AC-Delco | 22 |
| 3114961 | 1-1960-01MI | Hyster | 84 | 321-1820 | 1-2418-41DR | AC-Delco | 22 |
| 3114993 | 2-2099-ND | Hyster | 105 | 321-1822 | 1-2398-11DR | AC-Delco | 27 |
| 3114995 | 2-1728-MI-3 | Hyster | 92 | 321-1845 | 1-2419-21DR | AC-Delco | 22 |
| 3122813 | 2-2099-ND | Hyster | 105 | 321-1850 | 1-2320-21DR | AC-Delco | 21 |
| 3123908 | 1-1960-01MI | Hyster | 84 | 321-1852 | 1-2415-41DR | AC-Delco | 22 |
| 3124 | 2-1668-FD | Lester | 60 | 321-266 | 20-110-2 | AC-Delco | 10 |
| 3131 | 2-1674-FD | Lester | 60 | 321-267 | 20-110-2 | AC-Delco | 10 |

CROSS REFERENCE - REF# to CATALOG#

| Mfr. Part No. | Catalog No. | Mfr. Name | Pg. # | Mfr. Part No. | Catalog No. | Mfr. Name | Pg. # |
|---------------|---------------|-----------|-------|---------------|---------------|-----------|-------|
| 321-268 | 20-110-2 | AC-Delco | 10 | 321-649 | 20-104-1 | AC-Delco | 10 |
| 321-304 | 20-152-22-1 | AC-Delco | 23 | 321-653 | 20-104-1 | AC-Delco | 10 |
| 321-305 | 20-152-22-1 | AC-Delco | 23 | 321-654 | 20-127-1 | AC-Delco | 18 |
| 321-318 | 20-142-11-1 | AC-Delco | 22 | 321-655 | 20-178-1 | AC-Delco | 17 |
| 321-319 | 20-142-11-1 | AC-Delco | 22 | 321-660 | 20-118-1 | AC-Delco | 11 |
| 321-326 | 20-152-22-1 | AC-Delco | 23 | 321-665 | 20-118-1 | AC-Delco | 11 |
| 321-332 | 20-142-11-1 | AC-Delco | 22 | 321-666 | 20-117-1 | AC-Delco | 11 |
| 321-333 | 20-152-32-1 | AC-Delco | 24 | 321-667 | 20-113-1 | AC-Delco | 10 |
| 321-334 | 20-152-11-1 | AC-Delco | 23 | 321-670 | 20-1163-1 | AC-Delco | 19 |
| 321-338 | 20-145-31-1 | AC-Delco | 23 | 321-670 | 20-131-1 | AC-Delco | 18 |
| 321-340 | 20-152-11-1 | AC-Delco | 23 | 321-671 | 20-132-1 | AC-Delco | 18 |
| 321-341 | 20-152-31-1 | AC-Delco | 24 | 321-674 | 1-1915-00DR | AC-Delco | 11 |
| 321-342 | 20-152-31-1 | AC-Delco | 24 | 321-674 | 1-2333-00DR | AC-Delco | 14 |
| 321-343 | 20-142-32-1 | AC-Delco | 22 | 321-676 | 1-1916-00DR | AC-Delco | 12 |
| 321-359 | 20-110-2 | AC-Delco | 10 | 321-677 | 1-1917-00DR | AC-Delco | 12 |
| 321-38 | 1-2410-11DR | AC-Delco | 9 | 321-682 | 1-1915-00DR | AC-Delco | 11 |
| 321-38 | 1-2410-11DR-1 | AC-Delco | 9 | 321-682 | 1-2300-00DR | AC-Delco | 14 |
| 321-38 | 20-102-1 | AC-Delco | 10 | 321-682 | 1-2333-00DR | AC-Delco | 14 |
| 321-380 | 20-152-22-1 | AC-Delco | 23 | 321-683 | 1-2300-00DR | AC-Delco | 14 |
| 321-389 | 20-145-21-1 | AC-Delco | 23 | 321-683 | 1-2333-00DR | AC-Delco | 14 |
| 321-39 | 20-102-1 | AC-Delco | 10 | 321-685 | 1-2333-00DR | AC-Delco | 14 |
| 321-39 | 20-102-5 | AC-Delco | 10 | 321-686 | 1-2333-00DR | AC-Delco | 14 |
| 321-396 | 20-152-11-1 | AC-Delco | 23 | 321-687 | 1-1915-00DR | AC-Delco | 11 |
| 321-40 | 20-102-1 | AC-Delco | 10 | 321-687 | 1-1918-00DR | AC-Delco | 12 |
| 321-401 | 20-145-21-1 | AC-Delco | 23 | 321-688 | 1-2299-00DR | AC-Delco | 13 |
| 321-402 | 20-145-21-1 | AC-Delco | 23 | 321-689 | 1-2334-00DR | AC-Delco | 14 |
| 321-41 | 20-102-1 | AC-Delco | 10 | 321-689 | 1-2334-00DR-3 | AC-Delco | 14 |
| 321-414 | 20-145-31-1 | AC-Delco | 23 | 321-697 | 20-178-1 | AC-Delco | 17 |
| 321-42 | 20-102-1 | AC-Delco | 10 | 321-698 | 20-121-1 | AC-Delco | 16 |
| 321-43 | 20-102-1 | AC-Delco | 10 | 321-699 | 1-2301-00DR | AC-Delco | 17 |
| 321-43 | 20-102-5 | AC-Delco | 10 | 321-700 | 1-2301-00DR | AC-Delco | 17 |
| 321-431 | 20-152-32-1 | AC-Delco | 24 | 321-701 | 1-2300-00DR | AC-Delco | 14 |
| 321-431 | 20-184-32 | AC-Delco | 24 | 321-702 | 20-119-1 | AC-Delco | 16 |
| 321-434 | 20-152-22-1 | AC-Delco | 23 | 321-719 | 1-2297-00DR | AC-Delco | 13 |
| 321-435 | 20-189-11-1 | AC-Delco | 24 | 321-720 | 1-2300-00DR | AC-Delco | 14 |
| 321-436 | 20-189-11-1 | AC-Delco | 24 | 321-721 | 1-2334-00DR | AC-Delco | 14 |
| 321-437 | 20-145-11-1 | AC-Delco | 23 | 321-721 | 1-2334-00DR-3 | AC-Delco | 14 |
| 321-438 | 20-145-11-1 | AC-Delco | 23 | 321-723 | 1-2299-00DR | AC-Delco | 13 |
| 321-443 | 20-175-11 | AC-Delco | 27 | 321-731 | 1-2057-00DR-1 | AC-Delco | 19 |
| 321-444 | 20-175-11 | AC-Delco | 27 | 321-732 | 1-2057-00DR-1 | AC-Delco | 19 |
| 321-45 | 20-102-1 | AC-Delco | 10 | 321-733 | 1-2077-00DR-1 | AC-Delco | 19 |
| 321-455 | 20-142-11-1 | AC-Delco | 22 | 321-734 | 1-2077-00DR-1 | AC-Delco | 19 |
| 321-456 | 20-145-21-1 | AC-Delco | 23 | 321-735 | 1-2060-00DR-1 | AC-Delco | 20 |
| 321-457 | 20-145-21-1 | AC-Delco | 23 | 321-738 | 1-2044-00DR | AC-Delco | 14 |
| 321-46 | 20-102-1 | AC-Delco | 10 | 321-739 | 1-2065-00DR | AC-Delco | 15 |
| 321-47 | 20-102-1 | AC-Delco | 10 | 321-739 | 1-2065-00DR-3 | AC-Delco | 15 |
| 321-47 | 20-102-5 | AC-Delco | 10 | 321-740 | 1-2065-00DR | AC-Delco | 15 |
| 321-471 | 20-152-31-1 | AC-Delco | 24 | 321-740 | 1-2065-00DR-3 | AC-Delco | 15 |
| 321-475 | 20-184-32 | AC-Delco | 24 | 321-741 | 1-2078-00DR-1 | AC-Delco | 20 |
| 321-477 | 20-152-11-1 | AC-Delco | 23 | 321-741 | 1-2304-00DR-1 | AC-Delco | 20 |
| 321-478 | 20-152-32-1 | AC-Delco | 24 | 321-743 | 20-125-1 | AC-Delco | 17 |
| 321-48 | 20-102-1 | AC-Delco | 10 | 321-748 | 1-2558-00DR-1 | AC-Delco | 19 |
| 321-489 | 20-1105-41 | AC-Delco | 28 | 321-749 | 1-2280-00DR | AC-Delco | 15 |
| 321-490 | 20-1105-41 | AC-Delco | 28 | 321-750 | 1-2154-00DR | AC-Delco | 15 |
| 321-496 | 20-152-32-1 | AC-Delco | 24 | 321-764 | 1-2304-00DR-1 | AC-Delco | 20 |
| 321-552 | 20-175-11 | AC-Delco | 27 | 321-796 | 1-2662-00DR | AC-Delco | 16 |
| 321-555 | 20-145-21-1 | AC-Delco | 23 | 321-798 | 1-2663-00DR | AC-Delco | 16 |
| 321-576 | 20-175-11 | AC-Delco | 27 | 321-823 | 1-2662-00DR | AC-Delco | 16 |
| 321-585 | 20-1105-41 | AC-Delco | 28 | 3221 | 2-1799-FD-1 | Lester | 62 |
| 321-586 | 20-1105-41 | AC-Delco | 28 | 3223 | 2-1881-FD-1 | Lester | 62 |
| 321-596 | 20-175-11 | AC-Delco | 27 | 3224 | 2-1885-FD-1 | Lester | 62 |
| 321-599 | 20-142-11-1 | AC-Delco | 22 | 3225 | 2-1882-FD-1 | Lester | 62 |
| 321-600 | 20-119-1 | AC-Delco | 16 | 3226 | 2-1883-FD-1 | Lester | 62 |
| 321-602 | 20-121-1 | AC-Delco | 16 | 3227687 | 20-202 | Chrysler | 49 |
| 321-603 | 20-124-1 | AC-Delco | 17 | 3228506 | 20-202 | Chrysler | 49 |
| 321-604 | 20-126-1 | AC-Delco | 18 | 3231 | 2-1894-FD-1 | Lester | 63 |
| 321-605 | 20-124-1 | AC-Delco | 17 | 323-1063 | 2-2095-DR-2 | AC-Delco | 46 |
| 321-611 | 20-119-1 | AC-Delco | 16 | 323-1064 | 2-1796-DR | AC-Delco | 47 |
| 321-641 | 20-131-1 | AC-Delco | 18 | 323-1399 | 2-1954-DR-2 | AC-Delco | 44 |
| 321-643 | 20-133-1 | AC-Delco | 18 | 323-1400 | 2-2054-DR-2 | AC-Delco | 44 |
| 321-647 | 20-104-1 | AC-Delco | 10 | 323-1434 | 2-2112-DR-2 | AC-Delco | 45 |
| 321-648 | 20-104-1 | AC-Delco | 10 | 323-1444 | 2-2200-DR-2 | AC-Delco | 45 |

CROSS REFERENCE

CROSS REFERENCE - REF# to CATALOG#

| Mfr. Part# | Catalog# | Mfr. Name | Pg. # | Mfr. Part# | Catalog# | Mfr. Name | Pg. # |
|------------|-------------|-----------|-------|------------|-------------|-----------|-------|
| 323-1451 | 2-2211-DR-2 | AC-Delco | 45 | 323-768 | 50-111-1 | AC-Delco | 43 |
| 323-1459 | 2-1690-DR-2 | AC-Delco | 46 | 323-773 | 2-2899-DR | AC-Delco | 40 |
| 323-1467 | 2-2200-DR-2 | AC-Delco | 45 | 323-773 | 50-104-1 | AC-Delco | 41 |
| 323-1468 | 2-2211-DR-2 | AC-Delco | 45 | 323-773 | 50-104-2 | AC-Delco | 41 |
| 323-1470 | 2-2112-DR-2 | AC-Delco | 45 | 323-773 | 50-108-1 | AC-Delco | 41 |
| 323-1471 | 2-2143-DR-2 | AC-Delco | 45 | 323-773 | 50-108-2 | AC-Delco | 41 |
| 323-1475 | 2-2054-DR-2 | AC-Delco | 44 | 323-774 | 50-100-1 | AC-Delco | 40 |
| 323-1483 | 2-2336-DR | AC-Delco | 44 | 323-774 | 50-100-2 | AC-Delco | 40 |
| 323-1484 | 2-2112-DR-2 | AC-Delco | 45 | 323-775 | 50-104-1 | AC-Delco | 41 |
| 323-1485 | 2-2200-DR-2 | AC-Delco | 45 | 323-775 | 50-104-2 | AC-Delco | 41 |
| 323-1622 | 2-2200-DR-2 | AC-Delco | 45 | 323-777 | 50-103-1 | AC-Delco | 41 |
| 3232 | 50-220-1 | Lester | 64 | 323-777 | 50-103-2 | AC-Delco | 40 |
| 323-220 | 2-1601-DR-2 | AC-Delco | 48 | 323-778 | 50-108-1 | AC-Delco | 41 |
| 323-244 | 2-1595-DR | AC-Delco | 48 | 323-778 | 50-108-2 | AC-Delco | 41 |
| 323-254 | 2-1595-DR | AC-Delco | 48 | 323-779 | 50-100-1 | AC-Delco | 40 |
| 323-255 | 2-1593-DR | AC-Delco | 48 | 323-779 | 50-100-2 | AC-Delco | 40 |
| 323-255 | 2-1604-DR | AC-Delco | 48 | 323-783 | 50-104-1 | AC-Delco | 41 |
| 323-274 | 2-1593-DR | AC-Delco | 48 | 323-783 | 50-104-2 | AC-Delco | 41 |
| 323-274 | 2-1604-DR | AC-Delco | 48 | 323-784 | 2-2899-DR | AC-Delco | 40 |
| 323-289 | 2-1592-DR | AC-Delco | 47 | 323-789 | 2-2473-DR | AC-Delco | 43 |
| 323-292 | 2-1604-DR | AC-Delco | 48 | 3238 | 2-1894-FD-1 | Lester | 63 |
| 323-292 | 2-1607-DR | AC-Delco | 48 | 323-801 | 2-2286-DR | AC-Delco | 43 |
| 323-300 | 2-1413-DR | AC-Delco | 47 | 323-807 | 2-1601-DR-2 | AC-Delco | 48 |
| 323-349 | 2-1493-DR | AC-Delco | 47 | 323-818 | 50-113-1 | AC-Delco | 35 |
| 323-365 | 2-1592-DR | AC-Delco | 47 | 323-823 | 50-157-9 | AC-Delco | 28 |
| 323-367 | 2-1604-DR | AC-Delco | 48 | 323-824 | 50-157-9 | AC-Delco | 28 |
| 323-367 | 2-1607-DR | AC-Delco | 48 | 323-830 | 50-150-1 | AC-Delco | 42 |
| 323-368 | 2-1604-DR | AC-Delco | 48 | 323-830 | 50-150-2 | AC-Delco | 42 |
| 323-371 | 2-1601-DR-2 | AC-Delco | 48 | 323-834 | 50-158-1 | AC-Delco | 36 |
| 323-373 | 2-1598-DR-2 | AC-Delco | 48 | 323-835 | 50-159-1 | AC-Delco | 36 |
| 323-394 | 2-1474-DR-2 | AC-Delco | 46 | 323-836 | 50-159-1 | AC-Delco | 36 |
| 323-396 | 2-1474-DR-2 | AC-Delco | 46 | 323-837 | 50-161-1 | AC-Delco | 36 |
| 3234 | 2-1956-FD-1 | Lester | 64 | 323-839 | 50-113-1 | AC-Delco | 35 |
| 323-404 | 2-1474-DR-2 | AC-Delco | 46 | 323-840 | 50-193-1 | AC-Delco | 36 |
| 323-406 | 2-1580-DR | AC-Delco | 29 | 323-842 | 50-162-1 | AC-Delco | 36 |
| 323-407 | 50-8402-2 | AC-Delco | 29 | 323-843 | 2-1584-DR-2 | AC-Delco | 34 |
| 323-413 | 2-1493-DR | AC-Delco | 47 | 323-850 | 50-160-1 | AC-Delco | 36 |
| 323-419 | 50-8407 | AC-Delco | 30 | 323-851 | 50-160-1 | AC-Delco | 36 |
| 323-419 | 50-8420 | AC-Delco | 31 | 323-852 | 50-160-1 | AC-Delco | 36 |
| 323-419 | 50-8437 | AC-Delco | 33 | 323-855 | 50-150-1 | AC-Delco | 42 |
| 323-426 | 2-1413-DR | AC-Delco | 47 | 323-855 | 50-150-2 | AC-Delco | 42 |
| 323-437 | 50-8405 | AC-Delco | 29 | 323-858 | 50-151-1 | AC-Delco | 42 |
| 323-437 | 50-8431 | AC-Delco | 32 | 323-858 | 50-151-2 | AC-Delco | 42 |
| 323-438 | 50-8406-2 | AC-Delco | 30 | 323-858 | 50-151-3 | AC-Delco | 42 |
| 323-439 | 50-8406-2 | AC-Delco | 30 | 323-858 | 50-152-1 | AC-Delco | 42 |
| 323-440 | 50-8410 | AC-Delco | 30 | 323-858 | 50-152-2 | AC-Delco | 42 |
| 323-441 | 50-8410 | AC-Delco | 30 | 323-859 | 50-103-1 | AC-Delco | 41 |
| 323-442 | 50-8404 | AC-Delco | 29 | 323-859 | 50-103-2 | AC-Delco | 40 |
| 323-443 | 50-8404 | AC-Delco | 29 | 323-859 | 50-152-1 | AC-Delco | 42 |
| 323-446 | 2-1580-DR | AC-Delco | 29 | 323-859 | 50-152-2 | AC-Delco | 42 |
| 323-447 | 50-8402-2 | AC-Delco | 29 | 323-864 | 50-192-1 | AC-Delco | 43 |
| 323-450 | 50-8415 | AC-Delco | 30 | 323-864 | 50-192-2 | AC-Delco | 43 |
| 323-451 | 50-8403 | AC-Delco | 29 | 323-867 | 50-153-1 | AC-Delco | 43 |
| 323-456 | 2-1470-DR | AC-Delco | 47 | 323-867 | 50-153-2 | AC-Delco | 43 |
| 323-485 | 2-1690-DR-2 | AC-Delco | 46 | 323-868 | 50-159-1 | AC-Delco | 36 |
| 323-487 | 50-8407 | AC-Delco | 30 | 323-869 | 50-159-1 | AC-Delco | 36 |
| 323-487 | 50-8420 | AC-Delco | 31 | 323-871 | 2-2703-DR | AC-Delco | 42 |
| 3235 | 2-1953-FD-1 | Lester | 63 | 323-877 | 2-2471-DR | AC-Delco | 41 |
| 323-504 | 50-8425 | AC-Delco | 32 | 323-878 | 50-151-3 | AC-Delco | 42 |
| 323-528 | 2-1912-DR-2 | AC-Delco | 46 | 323-879 | 50-194-1 | AC-Delco | 37 |
| 323-59 | 2-1598-DR-2 | AC-Delco | 48 | 323-880 | 2-1582-DR-1 | AC-Delco | 34 |
| 323-618 | 50-103-1 | AC-Delco | 41 | 323-882 | 2-2471-DR | AC-Delco | 41 |
| 323-618 | 50-103-2 | AC-Delco | 40 | 323-884 | 50-158-1 | AC-Delco | 36 |
| 323-623 | 50-100-2 | AC-Delco | 40 | 323-885 | 50-161-1 | AC-Delco | 36 |
| 323-630 | 2-2596-DR-2 | AC-Delco | 49 | 323-889 | 2-2471-DR | AC-Delco | 41 |
| 323-730 | 50-159-1 | AC-Delco | 36 | 323-898 | 2-2471-DR | AC-Delco | 41 |
| 323-732 | 50-159-1 | AC-Delco | 36 | 3239 | 2-1885-FD-1 | Lester | 62 |
| 323-744 | 50-160-1 | AC-Delco | 36 | 323-901 | 2-2206-DR-1 | AC-Delco | 35 |
| 323-761 | 50-111 | AC-Delco | 43 | 323-902 | 50-192-1 | AC-Delco | 43 |
| 323-761 | 50-111-1 | AC-Delco | 43 | 323-902 | 50-192-2 | AC-Delco | 43 |
| 323-764 | 2-2474-DR | AC-Delco | 43 | 323-928 | 50-152-1 | AC-Delco | 42 |
| 323-768 | 50-111 | AC-Delco | 43 | 323-928 | 50-152-2 | AC-Delco | 42 |

CROSS REFERENCE

CROSS REFERENCE - REF# to CATALOG#

| Mfr. Part No. | Catalog No. | Mfr. Name | Pg. # | Mfr. Part No. | Catalog No. | Mfr. Name | Pg. # |
|---------------|---------------|----------------------|-------|---------------|---------------|---------------|-------|
| 323-948 | 50-153-1 | AC-Delco | 43 | 3510 | 2-1593-DR | Lester | 48 |
| 323-948 | 50-153-2 | AC-Delco | 43 | 3510M | 2-1604-DR | Lester | 48 |
| 3240 | 2-1895-FD-1 | Lester | 63 | 351940 | 1-2410-11DR | Caterpillar | 9 |
| 3241 | 2-1881-FD-1 | Lester | 62 | 351940 | 1-2410-11DR-1 | Caterpillar | 9 |
| 3246 | 2-1882-FD-1 | Lester | 62 | 35258940 | 50-8407 | Prestolite | 30 |
| 3247 | 2-1883-FD-1 | Lester | 62 | 35261220S | 2-1254-MI-2 | Leece-Neville | 87 |
| 3267 | 2-1799-FD-1 | Lester | 62 | 35261220S | 2-1748-MI-1 | Leece-Neville | 92 |
| 3268 | 2-1806-FD-1 | Lester | 62 | 355794R91 | 2-2287-DR | Case | 44 |
| 326875 | 2-1728-MI | Hyster | 85 | 355794R92 | 2-2287-DR | Case | 44 |
| 3271 | 50-237-1 | Lester | 64 | 3560 | 2-1595-DR | Lester | 48 |
| 3272 | 2-1887-FD-1 | Lester | 63 | 3582185C91 | 1-2532-00MO | IHC | 75 |
| 3273 | 2-1886-FD-1 | Lester | 63 | 3593752RX | 50-100-1 | Cummins | 40 |
| 3282883-M91 | 1-2312-01HI | Massey Ferguson | 65 | 3593752RX | 50-100-2 | Cummins | 40 |
| 3283813 | 2-2666 | Cummins | 109 | 3603848RX | 20-121-1 | Cummins | 16 |
| 3290 | 2-2899-DR | Lester | 40 | 3603850RX | 1-2301-00DR | Cummins | 17 |
| 32A66-00100 | 2-2102-MI | Mitsubishi Heavy Ind | 90 | 3603851RX | 20-124-1 | Cummins | 17 |
| 32A66-00101 | 2-2102-MI | Mitsubishi Heavy Ind | 90 | 3603852RX | 20-126-1 | Cummins | 18 |
| 3300 | 50-157-9 | Lester | 28 | 3603854RX | 20-133-1 | Cummins | 18 |
| 3332213 | 1-2558-00DR-1 | Cummins | 19 | 3603857RX | 20-501-1 | Cummins | 73 |
| 3339 | 50-100-1 | Lester | 40 | 3603858RX | 20-501-1 | Cummins | 73 |
| 3339 | 50-100-2 | Lester | 40 | 3603859RX | 20-501-1 | Cummins | 73 |
| 3339 | 50-108-1 | Lester | 41 | 3603862RX | 50-151-1 | Cummins | 42 |
| 3339 | 50-108-2 | Lester | 41 | 3603862RX | 50-151-2 | Cummins | 42 |
| 3339 | 50-193-1 | Lester | 36 | 3603862RX | 50-151-3 | Cummins | 42 |
| 334-1409 | 1-2389-01ND-2 | AC-Delco | 97 | 3603863RX | 50-104-1 | Cummins | 41 |
| 3353 | 50-159-1 | Lester | 36 | 3603863RX | 50-104-2 | Cummins | 41 |
| 335867 | 2-2753-DR-2 | Hyster | 49 | 3603863RX | 50-108-1 | Cummins | 41 |
| 336-1737 | 2-2320-HI-1 | AC-Delco | 72 | 3603863RX | 50-108-2 | Cummins | 41 |
| 3367 | 50-159-1 | Lester | 36 | 3603864RX | 50-150-1 | Cummins | 42 |
| 3368 | 50-159-1 | Lester | 36 | 3603864RX | 50-150-2 | Cummins | 42 |
| 3370 | 50-103-1 | Lester | 41 | 3603877RX | 20-131-1 | Cummins | 18 |
| 3370 | 50-103-2 | Lester | 40 | 3604225RX | 20-178-1 | Cummins | 17 |
| 3374 | 50-100-1 | Lester | 40 | 3604234RX | 20-502-1 | Cummins | 74 |
| 3374 | 50-100-2 | Lester | 40 | 3604652RX | 20-1163-1 | Cummins | 19 |
| 3400698 | 1-2558-00DR-1 | Cummins | 19 | 3604654RX | 50-8407 | Cummins | 30 |
| 34070-16081 | 2-2734-ND-2 | Kubota | 110 | 3604654RX | 50-8420 | Cummins | 31 |
| 34070-16083 | 2-2734-ND-2 | Kubota | 110 | 3604659RX | 20-125-1 | Cummins | 17 |
| 34070-16800 | 2-2734-ND-2 | Kubota | 110 | 3604877RX | 20-131-1 | Cummins | 18 |
| 34070-16803 | 2-2734-ND-2 | Kubota | 110 | 3610942 | 2-2703-DR | Cummins | 42 |
| 34070-75600 | 1-2478-01ND | Kubota | 99 | 3627 | 2-1595-DR | Lester | 48 |
| 34070-75601 | 1-2478-01ND | Kubota | 99 | 3635 | 2-1601-DR-2 | Lester | 48 |
| 34070-75602 | 1-2478-01ND | Kubota | 99 | 3675201RX | 1-2291-00DR | Cummins | 12 |
| 343-151-71-01 | 50-9100-1 | Mercedes | 5 | 3675219RX | 1-2304-00DR-1 | Cummins | 20 |
| 343274 | 50-161-1 | Caterpillar | 36 | 3675235RX | 1-2558-00DR-1 | Cummins | 19 |
| 34366-00101 | 2-2087-MI | Mitsubishi Heavy Ind | 89 | 3675245RX | 2-2666 | Cummins | 109 |
| 34366-00101 | 2-2087-MI-1 | Mitsubishi Heavy Ind | 89 | 3675250RX | 1-2571-00DR | Cummins | 16 |
| 34366-10100 | 2-2087-MI | Mitsubishi Heavy Ind | 89 | 3675252RX | 1-2571-00DR | Cummins | 16 |
| 34366-10100 | 2-2087-MI-1 | Mitsubishi Heavy Ind | 89 | 3675254RX | 1-2427-30DR | Cummins | 11 |
| 344-151-05-01 | 2-2669-BO | Mercedes | 5 | 369714 | 50-161-1 | Caterpillar | 36 |
| 34466-03101 | 2-2103-MI | Mitsubishi Heavy Ind | 90 | 3710 | 50-103-1 | Lester | 41 |
| 34466-03200 | 2-1963-MI | Mitsubishi Heavy Ind | 89 | 3710 | 50-103-2 | Lester | 40 |
| 34466-10103 | 2-2103-MI | Mitsubishi Heavy Ind | 90 | 3720 | 50-159-1 | Lester | 36 |
| 34466-15100 | 2-2103-MI | Mitsubishi Heavy Ind | 90 | 37300-41010 | 1-2434-01MI | Hyundai | 83 |
| 34466-15102 | 2-2103-MI | Mitsubishi Heavy Ind | 90 | 3733 | 2-1607-DR | Lester | 48 |
| 34466-15202 | 2-1963-MI | Mitsubishi Heavy Ind | 89 | 3745 | 50-104-1 | Lester | 41 |
| 34466-20100 | 2-2103-MI | Mitsubishi Heavy Ind | 90 | 3745 | 50-104-2 | Lester | 41 |
| 34466-20102 | 2-2103-MI | Mitsubishi Heavy Ind | 90 | 3745 | 50-108-1 | Lester | 41 |
| 34466-20200 | 2-1963-MI | Mitsubishi Heavy Ind | 89 | 3745 | 50-108-2 | Lester | 41 |
| 34466-20201 | 2-1963-MI | Mitsubishi Heavy Ind | 89 | 3745 | 50-151-1 | Lester | 42 |
| 34468-18200 | 1-2391-01MI | Mitsubishi Heavy Ind | 83 | 3745 | 50-151-2 | Lester | 42 |
| 34468-28100 | 1-2391-01MI | Mitsubishi Heavy Ind | 83 | 3745 | 50-151-3 | Lester | 42 |
| 34468-28200 | 1-2391-01MI | Mitsubishi Heavy Ind | 83 | 3755 | 50-9102 | Lester | 6 |
| 34766-10903 | 2-2087-MI | Mitsubishi Heavy Ind | 89 | 3767 | 50-108-1 | Lester | 41 |
| 34766-10903 | 2-2087-MI-1 | Mitsubishi Heavy Ind | 89 | 3767 | 50-108-2 | Lester | 41 |
| 34766-20900 | 2-2087-MI | Mitsubishi Heavy Ind | 89 | 3785 | 50-104-1 | Lester | 41 |
| 34766-20900 | 2-2087-MI-1 | Mitsubishi Heavy Ind | 89 | 3785 | 50-104-2 | Lester | 41 |
| 34766-20901 | 2-2087-MI | Mitsubishi Heavy Ind | 89 | 3785426 | 2-2103-MI | Clark | 90 |
| 34766-20901 | 2-2087-MI-1 | Mitsubishi Heavy Ind | 89 | 3790819 | 2-1727-MI | Clark | 85 |
| 34766-21301 | 2-1963-MI | Mitsubishi Heavy Ind | 89 | 379095 | 2-2103-MI | Clark | 90 |
| 34766-31300 | 2-1963-MI | Mitsubishi Heavy Ind | 89 | 380-10 | 3-1005-01LU | PIC | 77 |
| 34766-41300 | 2-1963-MI | Mitsubishi Heavy Ind | 89 | 383290C91 | 1-2301-00DR | IHC | 17 |
| 350-40 | 3-1021-FD | PIC | 60 | 3838 | 2-1592-DR | Lester | 47 |

CROSS REFERENCE

CROSS REFERENCE - REF# to CATALOG#

| Mfr. Part# | Catalog# | Mfr. Name | Pg. # | Mfr. Part# | Catalog# | Mfr. Name | Pg. # |
|---------------|-------------|----------------|-------|---------------|-------------|-------------|-------|
| 3872D304 | 2-2285-BO | Perkins | 4 | 3C3Z-11002-AA | 2-2215-FD | Ford | 61 |
| 388040 | 2-1728-MI | Hyster | 85 | 3E5382 | 2-2263-ND | Caterpillar | 107 |
| 3901386 | 50-157-9 | Cummins | 28 | 3E7863 | 2-2703-DR | Caterpillar | 42 |
| 3904445 | 50-157-9 | Cummins | 28 | 3L54-11000-AA | 2-1887-FD-1 | Ford | 63 |
| 3904466 | 2-1526-ND | Cummins | 102 | 3L5A-11000-AA | 2-1887-FD-1 | Ford | 63 |
| 3905 | 2-2473-DR | Lester | 43 | 3L5Z-11002-AA | 2-1887-FD-1 | Ford | 63 |
| 3906261 | 2-2459-LU | Cummins | 81 | 3R7356 | 50-103-1 | Caterpillar | 41 |
| 3908594 | 2-2207-DR-1 | Cummins | 35 | 3R7356 | 50-103-2 | Caterpillar | 40 |
| 3909982 | 20-113-1 | Cummins | 10 | 3T2655 | 50-100-1 | Caterpillar | 40 |
| 3910643 | 50-162-1 | Cummins | 36 | 3T2655 | 50-100-2 | Caterpillar | 40 |
| 3910644 | 50-160-1 | Cummins | 36 | 3T5649 | 2-1737-ND | Caterpillar | 103 |
| 3910645 | 50-150-1 | Cummins | 42 | 3Y8852 | 50-103-1 | Caterpillar | 41 |
| 3910645 | 50-150-2 | Cummins | 42 | 3Y8852 | 50-103-2 | Caterpillar | 40 |
| 3911516 | 2-2459-LU | Cummins | 81 | 4006D20G01 | 20-412 | Thermo King | 75 |
| 3912084 | 2-1397-ND-1 | Cummins | 102 | 4006D20G02 | 20-412 | Thermo King | 75 |
| 391632 | 2-2596-DR-2 | Clark | 49 | 4033 | 2-2287-DR | Lester | 44 |
| 3916854 | 50-8407 | Cummins | 30 | 4090084 | 2-2455-ND | Cummins | 108 |
| 3916854 | 50-8420 | Cummins | 31 | 41-0749 | 1-2436-01ND | Thermo King | 98 |
| 3916854 | 50-8437 | Cummins | 33 | 4132 | 2-2286-DR | Lester | 43 |
| 3918376 | 50-8420 | Cummins | 31 | 4169095 | 2-2283-BO | Fiat | 4 |
| 3918377 | 50-8421 | Cummins | 31 | 4169096 | 50-9101-1 | Fiat | 6 |
| 391887C91 | 20-102-1 | IHC | 10 | 4174 | 2-1598-DR-2 | Lester | 48 |
| 391890C91 | 20-102-1 | IHC | 10 | 421000-010 | 1-2441-01ND | Nippondenso | 97 |
| 39200292 | 82-6854 | MTE Hydraulics | 113 | 421000-011 | 1-2541-01BO | Nippondenso | 1 |
| 39200292 | 82-6854-1 | MTE Hydraulics | 113 | 4231018 | 2-2283-BO | Fiat | 4 |
| 39200295 | 82-6875 | MTE Hydraulics | 118 | 4234 | 2-2596-DR-2 | Lester | 49 |
| 39200321 | 82-6877 | Haldex-Barnes | 118 | 42488477 | 50-9110-1 | KHD | 7 |
| 39200380 | 82-6873 | MTE Hydraulics | 116 | 42498678 | 2-2463-BO | Iveco | 8 |
| 39200388 | 82-6854 | MTE Hydraulics | 113 | 4269114 | 2-2283-BO | Fiat | 4 |
| 39200388 | 82-6854-1 | MTE Hydraulics | 113 | 428000-010 | 2-2327-ND | Nippondenso | 108 |
| 39200397 | 82-6864 | MTE Hydraulics | 115 | 428000-046 | 2-2548-ND | Nippondenso | 108 |
| 39200398 | 82-6869 | Haldex-Barnes | 115 | 428000-073 | 2-2722-ND-2 | Nippondenso | 110 |
| 39200398 | 82-6869-1 | Haldex-Barnes | 115 | 428000-119 | 2-2455-ND | Nippondenso | 108 |
| 39200398 | 82-6874 | Haldex-Barnes | 116 | 428000-122 | 2-2773-ND | Nippondenso | 111 |
| 39200399 | 82-6880 | MTE Hydraulics | 117 | 428000-142 | 2-2774-ND | Nippondenso | 111 |
| 39200421 | 82-6877 | Haldex-Barnes | 118 | 428000-145 | 2-2886-ND | Nippondenso | 111 |
| 39200455 | 82-6886 | Haldex-Barnes | 119 | 428000-201 | 2-2327-ND | Nippondenso | 108 |
| 39200482 | 82-6864 | MTE Hydraulics | 115 | 428000-240 | 2-1981-ND-2 | Nippondenso | 104 |
| 3920403 | 2-1526-ND | Cummins | 102 | 428000-264 | 2-2656-ND | Nippondenso | 109 |
| 3920617 | 1-2291-00DR | Cummins | 12 | 430138C91 | 50-150-1 | IHC | 42 |
| 3920618 | 20-127-1 | Cummins | 18 | 430138C91 | 50-150-2 | IHC | 42 |
| 3920643 | 2-1526-ND | Cummins | 102 | 4314765 | 2-1612-MI | Clark | 88 |
| 3921402 | 2-2472-DR | Cummins | 41 | 4314765 | 2-1612-MI-2 | Clark | 88 |
| 392525 | 2-2308-MD | Tennant | 83 | 432644 | 2-2355-BO | Valeo | 8 |
| 3934777 | 1-2427-30DR | Cummins | 11 | 432644 | 2-2355-BO-1 | Valeo | 8 |
| 393820R91 | 20-101-1 | IHC | 9 | 432864 | 1-2762-01LU | Valeo | 77 |
| 3948 | 50-103-1 | Lester | 41 | 433316 | 2-2281-LU | Valeo | 79 |
| 3948 | 50-103-2 | Lester | 40 | 433316 | 2-2281-LU-1 | Valeo | 79 |
| 394906R91 | 50-161-1 | IHC | 36 | 433318 | 50-9109-1 | Valeo | 6 |
| 3955 | 50-103-1 | Lester | 41 | 433318 | 50-9124-1 | Valeo | 7 |
| 3955 | 50-103-2 | Lester | 40 | 433485 | 1-2619-01LU | Valeo | 76 |
| 3958 | 50-108-1 | Lester | 41 | 4349144 | 2-1383-ND-2 | Chrysler | 102 |
| 3958 | 50-108-2 | Lester | 41 | 436071 | 2-2302-LU | Valeo | 79 |
| 3972 | 50-159-1 | Lester | 36 | 436071 | 2-2302-LU-1 | Valeo | 79 |
| 3974 | 50-108-1 | Lester | 41 | 436073 | 50-9101-1 | Valeo | 6 |
| 3974 | 50-108-2 | Lester | 41 | 436075 | 2-2325-BO | Valeo | 5 |
| 3978 | 50-108-1 | Lester | 41 | 436077 | 50-9109-1 | Valeo | 6 |
| 3978 | 50-108-2 | Lester | 41 | 436077 | 50-9124-1 | Valeo | 7 |
| 3991 | 50-159-1 | Lester | 36 | 436170 | 1-2754-02LU | Valeo | 77 |
| 3C24-11000-AA | 2-1806-FD-1 | Ford | 62 | 436186 | 1-2762-01LU | Valeo | 77 |
| 3C24-11000-CA | 2-1799-FD-1 | Ford | 62 | 436223 | 1-2754-02LU | Valeo | 77 |
| 3C2Z-11002-AA | 2-1806-FD-1 | Ford | 62 | 436428 | 1-2711-00BO | Valeo | 2 |
| 3C2Z-11002-CA | 2-1799-FD-1 | Ford | 62 | 436489 | 1-2741-01VA | Valeo | 112 |
| 3C3T-10300-AA | 1-2531-11FD | Ford | 59 | 436497 | 1-2436-01ND | Valeo | 98 |
| 3C3T-10300-AC | 1-2531-11FD | Ford | 59 | 436497 | 1-2476-01ND | Valeo | 99 |
| 3C3T-10300-DA | 1-2504-31FD | Ford | 58 | 436498 | 1-2119-11ND | Valeo | 98 |
| 3C3T-10300-EA | 1-2531-11FD | Ford | 59 | 436504 | 1-2479-01MI | Valeo | 84 |
| 3C3U-11000-AB | 2-2215-FD | Ford | 61 | 436507 | 1-1112-01 | Valeo | 65 |
| 3C3U-11000-AC | 2-2215-FD | Ford | 61 | 436507 | 1-2314-01HI | Valeo | 66 |
| 3C3Z-10346-AA | 1-2531-11FD | Ford | 59 | 436507 | 1-2332-01HI | Valeo | 66 |
| 3C3Z-10346-DA | 1-2504-31FD | Ford | 58 | 436530 | 1-2312-01HI | Valeo | 65 |
| 3C3Z-10346-EA | 1-2531-11FD | Ford | 59 | 436591 | 1-2711-00BO | Valeo | 2 |

CROSS REFERENCE - REF# to CATALOG#

| Mfr. Part No. | Catalog No. | Mfr. Name | Pg. # | Mfr. Part No. | Catalog No. | Mfr. Name | Pg. # |
|---------------|---------------|-------------|-------|---------------|-------------|------------|-------|
| 436680 | 1-2614-01VA | Valeo | 112 | 46-2099 | 82-6868-1 | Prestolite | 121 |
| 436715 | 1-2762-01LU | Valeo | 77 | 46-2099 | 82-6868-2 | Prestolite | 122 |
| 437144 | 1-2434-01MI | Valeo | 83 | 46-2099 | 82-6868-3 | Prestolite | 122 |
| 437734 | 1-2454-01MM | Valeo | 76 | 46-2099 | 82-6884 | Prestolite | 122 |
| 4379143 | 2-1383-ND-2 | Chrysler | 102 | 46-2107 | 82-6861 | Prestolite | 114 |
| 4379144 | 2-1383-ND-2 | Chrysler | 102 | 46-2126 | 82-6862 | Prestolite | 115 |
| 4379160 | 2-1383-ND-2 | Chrysler | 102 | 46-2155 | 82-6888 | Prestolite | 117 |
| 438012 | 2-2294-VA | Valeo | 112 | 46-2194 | 82-6862 | Prestolite | 115 |
| 438032 | 50-9117 | Valeo | 7 | 46-2220 | 82-6860 | Prestolite | 114 |
| 438169 | 2-2463-BO | Valeo | 8 | 46-2220 | 82-6860-1 | Prestolite | 114 |
| 439039 | 1-2741-01VA | Valeo | 112 | 46-2220 | 82-6860-2 | Prestolite | 114 |
| 439677R91 | 50-151-1 | IHC | 42 | 46-2220 | 82-6860-3 | Prestolite | 114 |
| 439677R91 | 50-151-2 | IHC | 42 | 46-2244 | 82-6888 | Prestolite | 117 |
| 439677R91 | 50-151-3 | IHC | 42 | 46-2262 | 82-6866 | Prestolite | 121 |
| 4428221 | 2-1397-ND-1 | Chrysler | 102 | 46-2285 | 82-6868-1 | Prestolite | 121 |
| 44-2918 | 2-1734-HI | Thermo King | 70 | 46-2285 | 82-6868-2 | Prestolite | 122 |
| 44-3325 | 20-412 | Thermo King | 75 | 46-2285 | 82-6868-3 | Prestolite | 122 |
| 44-5443 | 2-1734-HI | Thermo King | 70 | 46-2285 | 82-6884 | Prestolite | 122 |
| 44-5674 | 2-1193-ND | Thermo King | 101 | 46-2287 | 82-6868-1 | Prestolite | 121 |
| 44-8499 | 1-2237-00BO | Thermo King | 2 | 46-2287 | 82-6868-2 | Prestolite | 122 |
| 45-1229 | 2-1193-ND | Thermo King | 101 | 46-2287 | 82-6868-3 | Prestolite | 122 |
| 45-1229 | 2-1734-HI | Thermo King | 70 | 46-2287 | 82-6884 | Prestolite | 122 |
| 45-1263 | 2-1776-HI | Thermo King | 70 | 46-2369 | 82-6861 | Prestolite | 114 |
| 45-1285 | 2-1734-HI | Thermo King | 70 | 46-2401 | 82-6868-1 | Prestolite | 121 |
| 45-1312 | 2-2705-ND-2 | Thermo King | 109 | 46-2401 | 82-6868-2 | Prestolite | 122 |
| 45-1671 | 2-1776-HI | Thermo King | 70 | 46-2401 | 82-6868-3 | Prestolite | 122 |
| 45-1688 | 2-2318-HI | Thermo King | 72 | 46-2401 | 82-6884 | Prestolite | 122 |
| 45-1718 | 2-2705-ND-2 | Thermo King | 109 | 46-2414 | 82-6861 | Prestolite | 114 |
| 45-1993 | 2-1776-HI | Thermo King | 70 | 46-2415 | 82-7850 | Prestolite | 120 |
| 4525 | 2-2753-DR-2 | Lester | 49 | 46-2426 | 82-6868-1 | Prestolite | 121 |
| 455514 | 2-2638 | Valeo | 93 | 46-2426 | 82-6868-2 | Prestolite | 122 |
| 455516 | 50-9110-1 | Valeo | 7 | 46-2426 | 82-6868-3 | Prestolite | 122 |
| 455518 | 50-9122-1 | Valeo | 7 | 46-2426 | 82-6884 | Prestolite | 122 |
| 455520 | 50-9108 | Valeo | 6 | 46-2432 | 82-6870 | Prestolite | 116 |
| 455520 | 50-9122-1 | Valeo | 7 | 46-2451 | 82-6862 | Prestolite | 115 |
| 455527 | 50-9100-1 | Valeo | 5 | 46-2473 | 82-6852 | Prestolite | 119 |
| 455528 | 2-2298-BO | Valeo | 4 | 46-2473 | 82-6852-1 | Prestolite | 119 |
| 455585 | 2-1682-ND | Valeo | 100 | 46-2473 | 82-6889 | Prestolite | 120 |
| 45-5657 | 2-1193-ND | Thermo King | 101 | 46-2478 | 82-6855 | Prestolite | 113 |
| 45-56572 | 2-1193-ND | Thermo King | 101 | 46-2478 | 82-6871-1 | Prestolite | 116 |
| 45-5674 | 2-1193-ND | Thermo King | 101 | 46-2495 | 82-6869 | Prestolite | 115 |
| 455720 | 2-2355-BO | Valeo | 8 | 46-2495 | 82-6869-1 | Prestolite | 115 |
| 455720 | 2-2355-BO-1 | Valeo | 8 | 46-2495 | 82-6874 | Prestolite | 116 |
| 4557301 | 1-1527-02ND-2 | Chrysler | 96 | 46-2516 | 82-6869 | Prestolite | 115 |
| 455735 | 2-2294-VA | Valeo | 112 | 46-2516 | 82-6869-1 | Prestolite | 115 |
| 455911 | 2-2235-HI | Valeo | 71 | 46-2516 | 82-6874 | Prestolite | 116 |
| 455960 | 2-2638 | Valeo | 93 | 46-2520 | 82-6880 | Prestolite | 117 |
| 458192 | 2-2463-BO | Valeo | 8 | 46-2534 | 82-6869 | Prestolite | 115 |
| 458469 | 2-2355-BO-1 | Valeo | 8 | 46-2534 | 82-6869-1 | Prestolite | 115 |
| 4600 | 50-111 | Lester | 43 | 46-2534 | 82-6874 | Prestolite | 116 |
| 4600 | 50-111-1 | Lester | 43 | 46-2543 | 82-6879 | Prestolite | 117 |
| 46-0416 | 82-6879 | Prestolite | 117 | 46-2550 | 82-6855 | Prestolite | 113 |
| 46-0620 | 82-6876 | Prestolite | 118 | 46-2550 | 82-6871-1 | Prestolite | 116 |
| 46-103 | 82-6868-1 | Prestolite | 121 | 46-2552 | 82-6862 | Prestolite | 115 |
| 46-103 | 82-6868-2 | Prestolite | 122 | 46-2559 | 82-6862 | Prestolite | 115 |
| 46-103 | 82-6868-3 | Prestolite | 122 | 46-2570 | 82-6862 | Prestolite | 115 |
| 46-103 | 82-6884 | Prestolite | 122 | 46-2584 | 82-6852 | Prestolite | 119 |
| 46-175 | 82-6862 | Prestolite | 115 | 46-2584 | 82-6852-1 | Prestolite | 119 |
| 46-2001 | 82-7850 | Prestolite | 120 | 46-2584 | 82-6889 | Prestolite | 120 |
| 46-2014 | 82-6855 | Prestolite | 113 | 46-2585 | 82-6861 | Prestolite | 114 |
| 46-2014 | 82-6871-1 | Prestolite | 116 | 46-2595 | 82-6861 | Prestolite | 114 |
| 46-2015 | 82-6855 | Prestolite | 113 | 46-2604 | 82-6888 | Prestolite | 117 |
| 46-2015 | 82-6871-1 | Prestolite | 116 | 46-2610 | 82-6879 | Prestolite | 117 |
| 46-2018 | 82-6880 | Prestolite | 117 | 46-2611 | 82-6879 | Prestolite | 117 |
| 46-2037 | 82-6855 | Prestolite | 113 | 46-2624 | 82-6854 | Prestolite | 113 |
| 46-2037 | 82-6871-1 | Prestolite | 116 | 46-2624 | 82-6854-1 | Prestolite | 113 |
| 46-2054 | 82-6869 | Prestolite | 115 | 46-2624 | 82-6873 | Prestolite | 116 |
| 46-2054 | 82-6869-1 | Prestolite | 115 | 46-2636 | 82-6868-1 | Prestolite | 121 |
| 46-2054 | 82-6874 | Prestolite | 116 | 46-2636 | 82-6868-2 | Prestolite | 122 |
| 46-2073 | 82-6876 | Prestolite | 118 | 46-2636 | 82-6868-3 | Prestolite | 122 |
| 46-2086 | 82-6862 | Prestolite | 115 | 46-2636 | 82-6884 | Prestolite | 122 |
| 46-2093 | 82-6861 | Prestolite | 114 | 46-2637 | 82-6875 | Prestolite | 118 |

CROSS REFERENCE

CROSS REFERENCE - REF# to CATALOG#

| Mfr. Part# | Catalog# | Mfr. Name | Pg. # | Mfr. Part# | Catalog# | Mfr. Name | Pg. # |
|------------|-----------|------------|-------|--------------|-------------|---------------|-------|
| 46-2662 | 82-6854 | Prestolite | 113 | 46-717 | 82-6861 | Prestolite | 114 |
| 46-2662 | 82-6854-1 | Prestolite | 113 | 46-72 | 82-6855 | Prestolite | 113 |
| 46-2662 | 82-6873 | Prestolite | 116 | 46-72 | 82-6871-1 | Prestolite | 116 |
| 46-2777 | 82-6860 | Prestolite | 114 | 46-7610 | 2-1781-MI | Toro | 88 |
| 46-2777 | 82-6860-1 | Prestolite | 114 | 46-783 | 82-6862 | Prestolite | 115 |
| 46-2777 | 82-6860-2 | Prestolite | 114 | 46-806 | 82-6853 | Prestolite | 120 |
| 46-2777 | 82-6860-3 | Prestolite | 114 | 46-812 | 82-6870 | Prestolite | 116 |
| 46-2782 | 82-6860 | Prestolite | 114 | 4682998 | 2-2325-BO | Fiat | 5 |
| 46-2782 | 82-6860-1 | Prestolite | 114 | 4682999 | 2-2283-BO | Fiat | 4 |
| 46-2782 | 82-6860-2 | Prestolite | 114 | 46-854 | 82-7850 | Prestolite | 120 |
| 46-2782 | 82-6860-3 | Prestolite | 114 | 46-888 | 82-6855 | Prestolite | 113 |
| 46-2811 | 82-6875 | Prestolite | 118 | 46-888 | 82-6871-1 | Prestolite | 116 |
| 46-349 | 82-6861 | Prestolite | 114 | 4691200 | 50-9108 | Fiat | 6 |
| 4635 | 50-108-1 | Lester | 41 | 46-917 | 82-6855 | Prestolite | 113 |
| 4635 | 50-108-2 | Lester | 41 | 46-917 | 82-6871-1 | Prestolite | 116 |
| 46-3520 | 82-6861 | Prestolite | 114 | 4692477 | 2-2283-BO | Fiat | 4 |
| 46-3550 | 82-6880 | Prestolite | 117 | 46-9248 | 82-7861 | Prestolite | 118 |
| 46-3553 | 82-6861 | Prestolite | 114 | 46-933 | 82-6880 | Prestolite | 117 |
| 46-3563 | 82-6855 | Prestolite | 113 | 46-948 | 82-6860 | Prestolite | 114 |
| 46-3563 | 82-6871-1 | Prestolite | 116 | 46-948 | 82-6860-1 | Prestolite | 114 |
| 46-3564 | 82-6870 | Prestolite | 116 | 46-948 | 82-6860-2 | Prestolite | 114 |
| 46-3593 | 82-6875 | Prestolite | 118 | 46-948 | 82-6860-3 | Prestolite | 114 |
| 46-3618 | 82-6852 | Prestolite | 119 | 46-958 | 82-6855 | Prestolite | 113 |
| 46-3618 | 82-6852-1 | Prestolite | 119 | 46-958 | 82-6871-1 | Prestolite | 116 |
| 46-3618 | 82-6889 | Prestolite | 120 | 46-969 | 82-6855 | Prestolite | 113 |
| 46-3623 | 82-6875 | Prestolite | 118 | 46-969 | 82-6871-1 | Prestolite | 116 |
| 46-3627 | 82-6872-1 | Prestolite | 113 | 46-974 | 82-6855 | Prestolite | 113 |
| 46-3639 | 82-6875 | Prestolite | 118 | 46-974 | 82-6871-1 | Prestolite | 116 |
| 46-3650 | 82-6890 | Prestolite | 122 | 46-975 | 82-6855 | Prestolite | 113 |
| 46-3663 | 82-6887 | Prestolite | 117 | 46-975 | 82-6871-1 | Prestolite | 116 |
| 46-3938 | 82-6852 | Prestolite | 119 | 46-990 | 82-6855 | Prestolite | 113 |
| 46-3938 | 82-6852-1 | Prestolite | 119 | 46-990 | 82-6871-1 | Prestolite | 116 |
| 46-3938 | 82-6889 | Prestolite | 120 | 46-992 | 82-6880 | Prestolite | 117 |
| 46-4036 | 82-6872-1 | Prestolite | 113 | 4699705 | 50-9101-1 | Fiat | 6 |
| 46-4038 | 82-6869 | Prestolite | 115 | 4701920 | 2-2283-BO | Fiat | 4 |
| 46-4038 | 82-6869-1 | Prestolite | 115 | 4702248 | 50-9101-1 | Fiat | 6 |
| 46-4038 | 82-6874 | Prestolite | 116 | 4703751 | 50-9101-1 | Fiat | 6 |
| 46-4048 | 82-6885 | Prestolite | 117 | 4706008 | 50-9122-1 | Fiat | 7 |
| 46-4048 | 82-7851 | Prestolite | 118 | 4706720 | 2-2284-BO | Fiat | 4 |
| 46-4050 | 82-6855 | Prestolite | 113 | 4706931 | 50-9108 | Fiat | 6 |
| 46-4050 | 82-6871-1 | Prestolite | 116 | 4710224 | 2-2325-BO | Fiat | 5 |
| 46-4057 | 82-6854 | Prestolite | 113 | 4713806 | 50-9105-1 | Fiat | 6 |
| 46-4057 | 82-6854-1 | Prestolite | 113 | 4716026 | 50-9122-1 | Fiat | 7 |
| 46-4058 | 82-6859 | Prestolite | 114 | 4716062 | 50-9122-1 | Fiat | 7 |
| 46-4068 | 82-6855 | Prestolite | 113 | 4719666 | 50-9105-1 | Fiat | 6 |
| 46-4068 | 82-6871-1 | Prestolite | 116 | 4728682 | 2-2325-BO | Fiat | 5 |
| 46-4071 | 82-6858 | Prestolite | 121 | 4735444 | 2-2283-BO | Fiat | 4 |
| 46-4072 | 82-6885 | Prestolite | 117 | 4737754 | 2-2283-BO | Fiat | 4 |
| 46-4154 | 82-6869 | Prestolite | 115 | 4737755 | 50-9101-1 | Fiat | 6 |
| 46-4154 | 82-6869-1 | Prestolite | 115 | 4737756 | 50-9122-1 | Fiat | 7 |
| 46-4154 | 82-6874 | Prestolite | 116 | 4737757 | 2-2284-BO | Fiat | 4 |
| 46-4157 | 82-6868-1 | Prestolite | 121 | 4737759 | 50-9105-1 | Fiat | 6 |
| 46-4157 | 82-6868-2 | Prestolite | 122 | 4744811 | 50-9108 | Iveco | 6 |
| 46-4157 | 82-6868-3 | Prestolite | 122 | 4744841 | 50-9108 | Fiat | 6 |
| 46-4157 | 82-6884 | Prestolite | 122 | 4746 | 50-103-1 | Lester | 41 |
| 46-4166 | 82-6860 | Prestolite | 114 | 4746 | 50-103-2 | Lester | 40 |
| 46-4166 | 82-6860-1 | Prestolite | 114 | 4755108 | 2-2283-BO | Fiat | 4 |
| 46-4166 | 82-6860-2 | Prestolite | 114 | 4755109 | 50-9101-1 | Fiat | 6 |
| 46-4166 | 82-6860-3 | Prestolite | 114 | 4755110 | 50-9105-1 | Fiat | 6 |
| 46-419 | 82-6872-1 | Prestolite | 113 | 4755111 | 50-9122-1 | Fiat | 7 |
| 46-4195 | 82-7861 | Prestolite | 118 | 4755113 | 2-2284-BO | Fiat | 4 |
| 46-4196 | 82-7852 | Prestolite | 120 | 4759929 | 2-2325-BO | Fiat | 5 |
| 46-4200 | 82-6888 | Prestolite | 117 | 4774976 | 50-9115 | Fiat | 7 |
| 46-4214 | 82-6868-1 | Prestolite | 121 | 47749764 | 50-9115 | Fiat | 7 |
| 46-4214 | 82-6868-2 | Prestolite | 122 | 4780-18-400 | 2-2088-MI | Mazda | 86 |
| 46-4214 | 82-6868-3 | Prestolite | 122 | 4780-18-400A | 2-2088-MI | Mazda | 86 |
| 46-4214 | 82-6884 | Prestolite | 122 | 4800J | 1-2655-00LN | Leece-Neville | 74 |
| 46-4220 | 82-6864 | Prestolite | 115 | 4800JB | 1-2655-00LN | Leece-Neville | 74 |
| 46-555 | 82-6888 | Prestolite | 117 | 4801253AA | 2-2697-MI | Chrysler | 93 |
| 46-557 | 82-6888 | Prestolite | 117 | 4833LGH | 1-2661-00LN | Leece-Neville | 75 |
| 46-584 | 82-6862 | Prestolite | 115 | 4834LC | 1-2658-00LN | Leece-Neville | 74 |
| 465930 | 50-9115 | Volvo | 7 | 4836AAH | 1-2652-00LN | Leece-Neville | 74 |

CROSS REFERENCE

CROSS REFERENCE - REF# to CATALOG#

| Mfr. Part No. | Catalog No. | Mfr. Name | Pg. # | Mfr. Part No. | Catalog No. | Mfr. Name | Pg. # |
|---------------|---------------|---------------------|-------|---------------|---------------|----------------|-------|
| 4840-18-400 | 2-2024-MI | Mazda | 89 | 50-831001961 | 2-2709-ND-2 | Mercury Marine | 110 |
| 4840-18-400A | 2-2024-MI | Mazda | 89 | 5086932AA | 2-2455-ND | Chrysler | 108 |
| 4840-18-400B | 2-2024-MI | Mazda | 89 | 510275C91 | 50-153-1 | IHC | 43 |
| 4854420MO48HM | 82-7859 | United Technologies | 120 | 510275C91 | 50-153-2 | IHC | 43 |
| 4854440 | 82-7859 | Johnson Electric | 120 | 5103581AA | 2-2355-BO | Chrysler | 8 |
| 4860J | 1-2653-00LN | Leece-Neville | 74 | 5103581AA | 2-2355-BO-1 | Chrysler | 8 |
| 4860JB | 1-2653-00LN | Leece-Neville | 74 | 5103581AB | 2-2355-BO | Chrysler | 8 |
| 4893-18-400B | 2-2706-MI | Mazda | 86 | 5103581AB | 2-2355-BO-1 | Chrysler | 8 |
| 4893-18-400D | 2-2706-MI | Mazda | 86 | 5103885AA | 1-2768-01BO | Chrysler | 3 |
| 4893-18-400E | 2-1728-MI | Mazda | 85 | 5103887AA | 1-2589-01BO | Chrysler | 3 |
| 4894-18-400B | 2-1729-MI | Mazda | 85 | 510751 | 2-2824-MI | Prevost | 92 |
| 4894-18-400D | 2-1729-MI | Mazda | 85 | 5111319 | 50-9900 | Fiat | 49 |
| 4897 | 2-2474-DR | Lester | 43 | 511146C91 | 1-2301-00DR | IHC | 17 |
| 489716C91 | 50-151-1 | IHC | 42 | 5117537AA | 2-2355-BO | Chrysler | 8 |
| 489716C91 | 50-151-2 | IHC | 42 | 5117537AA | 2-2355-BO-1 | Chrysler | 8 |
| 489716C91 | 50-151-3 | IHC | 42 | 5117537AB | 2-2355-BO | Chrysler | 8 |
| 4906 | 50-159-1 | Lester | 36 | 5117537AB | 2-2355-BO-1 | Chrysler | 8 |
| 4927 | 50-111 | Lester | 43 | 5117587AA | 1-2852-01BO | Chrysler | 3 |
| 4927 | 50-111-1 | Lester | 43 | 5117587AB | 1-2852-01BO | Chrysler | 3 |
| 4930 | 50-111 | Lester | 43 | 51-178 | 20-601 | Prestolite | 111 |
| 4930 | 50-111-1 | Lester | 43 | 5119319 | 50-9900 | Fiat | 49 |
| 4937 | 50-111 | Lester | 43 | 51-212 | 20-601 | Prestolite | 111 |
| 4937 | 50-111-1 | Lester | 43 | 51-26101-7192 | 1-2711-00BO | MAN | 2 |
| 4987 | 50-103-1 | Lester | 41 | 51-26101-7192 | 1-2711-01BO | MAN | 2 |
| 4987 | 50-103-2 | Lester | 40 | 51-26101-7195 | 1-2711-00BO | MAN | 2 |
| 4997 | 50-160-1 | Lester | 36 | 51-26101-7195 | 1-2711-01BO | MAN | 2 |
| 4BD00355 | 82-6877 | HalDEX-Barnes | 118 | 51-26101-9192 | 1-2711-00BO | MAN | 2 |
| 4BD02273 | 82-6878 | HalDEX-Barnes | 119 | 51-26101-9192 | 1-2711-01BO | MAN | 2 |
| 4C3T-10300-AA | 1-2531-11FD | Ford | 59 | 51-26201-7114 | 50-9117 | MAN | 7 |
| 4C3Z-10346-AA | 1-2531-11FD | Ford | 59 | 51-26201-7129 | 50-9117 | MAN | 7 |
| 4C4Z-10346-FA | 1-2428-00DR-3 | Ford | 15 | 51-26201-7137 | 50-9117 | MAN | 7 |
| 4C4Z-10346-LA | 1-2154-00DR | Ford | 15 | 51-26201-7159 | 50-9117 | MAN | 7 |
| 4C4Z-10346-PA | 1-2532-00MO | Ford | 75 | 51-26201-9123 | 50-9117 | MAN | 7 |
| 4C4Z-11002-CA | 2-2391-DR | Ford | 34 | 51-26201-9159 | 50-9117 | MAN | 7 |
| 4L3U-10300-BA | 1-2539-31FD | Ford | 59 | 513303C91 | 20-501-1 | IHC | 73 |
| 4L3Z-10346-BA | 1-2539-31FD | Ford | 59 | 5134199AA | 1-2768-01BO | Chrysler | 3 |
| 4L3Z-10346-BB | 1-2539-31FD | Ford | 59 | 5134199AB | 1-2768-01BO | Chrysler | 3 |
| 4M4615 | 50-111 | Caterpillar | 43 | 5134205AA | 1-2589-01BO | Chrysler | 3 |
| 4M4615 | 50-111-1 | Caterpillar | 43 | 5134205AB | 1-2589-01BO | Chrysler | 3 |
| 4N0957 | 50-151-1 | Caterpillar | 42 | 5134510AA | 2-2355-BO | Chrysler | 8 |
| 4N0957 | 50-151-2 | Caterpillar | 42 | 5134510AA | 2-2355-BO-1 | Chrysler | 8 |
| 4N0957 | 50-151-3 | Caterpillar | 42 | 5134510AB | 2-2355-BO | Chrysler | 8 |
| 4N3182 | 50-152-1 | Caterpillar | 42 | 5134510AB | 2-2355-BO-1 | Chrysler | 8 |
| 4N3182 | 50-152-2 | Caterpillar | 42 | 513542C91 | 20-501-1 | IHC | 73 |
| 4N7905 | 50-152-1 | Caterpillar | 42 | 514089C91 | 20-501-1 | IHC | 73 |
| 4N7905 | 50-152-2 | Caterpillar | 42 | 51-8250 | 1-2391-01MI | Toro | 83 |
| 4N8118 | 50-151-1 | Caterpillar | 42 | 5196 | 82-6888 | Lester | 117 |
| 4N8118 | 50-151-2 | Caterpillar | 42 | 5200 | 82-7850 | Lester | 120 |
| 4N8118 | 50-151-3 | Caterpillar | 42 | 521829C91 | 20-131-1 | IHC | 18 |
| 4R3T-11000-AA | 2-1886-FD-1 | Ford | 63 | 5233662 | 2-1383-ND-2 | Chrysler | 102 |
| 4R3T-11000-AB | 2-1886-FD-1 | Ford | 63 | 5234026 | 1-1527-02ND-2 | Chrysler | 96 |
| 4R3Z-11002-AA | 2-1886-FD-1 | Ford | 63 | 5234028 | 1-1503-01ND-2 | Chrysler | 95 |
| 5000240884 | 2-2297-BO | Renault | 4 | 5234199 | 1-1504-01ND-2 | Chrysler | 95 |
| 5000241777 | 50-9117 | Renault | 7 | 5234201 | 1-1527-02ND-2 | Chrysler | 96 |
| 5000791211 | 2-2680-BO | Renault | 5 | 5234374 | 1-1504-05ND-2 | Chrysler | 95 |
| 5000804191 | 50-9115 | Renault | 7 | 524023C91 | 20-178-1 | IHC | 17 |
| 5000806878 | 50-9117 | Renault | 7 | 527888C91 | 50-151-1 | IHC | 42 |
| 5001000061 | 50-9117 | Renault | 7 | 527888C91 | 50-151-2 | IHC | 42 |
| 5001014221 | 2-2680-BO | Renault | 5 | 527888C91 | 50-151-3 | IHC | 42 |
| 5001-8101-00 | 1-2312-01HI | Toyosha | 65 | 527890C91 | 20-504-1 | IHC | 74 |
| 50027532 | 2-2553-BO | Yale | 8 | 528965C91 | 20-133-1 | IHC | 18 |
| 5010090370 | 2-2680-BO | Renault | 5 | 529965R92 | 2-2707-BO-2 | IHC | 5 |
| 5010090683 | 2-2680-BO | Renault | 5 | 529965R93 | 2-2707-BO-2 | IHC | 5 |
| 5010099875 | 1-2614-01VA | Renault | 112 | 53005984 | 2-1398-ND-2 | Chrysler | 102 |
| 5010217215 | 50-9115 | Renault | 7 | 53008646 | 1-1527-02ND-2 | Chrysler | 96 |
| 50316401 | 2-2362-BO | Hatz | 8 | 53008647 | 1-1503-05ND-2 | Chrysler | 95 |
| 5073919AA | 2-2355-BO | Chrysler | 8 | 53008651 | 1-1504-06ND-2 | Chrysler | 96 |
| 5073919AA | 2-2355-BO-1 | Chrysler | 8 | 532176R91 | 20-101-1 | IHC | 9 |
| 50-805991 | 50-8407 | Mercury Marine | 30 | 537140R94 | 2-2303-LU | IHC | 80 |
| 50-831001562 | 2-2709-ND-2 | Mercury Marine | 110 | 5381 | 82-6879 | Lester | 117 |
| 50-831001671 | 2-2276-ND | Mercury Marine | 101 | 54022053 | 1-2762-01LU | Marelli | 77 |
| 50-831001672 | 2-2276-ND | Mercury Marine | 101 | 54022054 | 1-2762-01LU | Marelli | 77 |

CROSS REFERENCE

CROSS REFERENCE - REF# to CATALOG#

| Mfr. Part# | Catalog# | Mfr. Name | Pg. # | Mfr. Part# | Catalog# | Mfr. Name | Pg. # |
|------------|---------------|-----------|-------|---------------|---------------|-----------------|-------|
| 54022059 | 1-2754-02LU | Marelli | 77 | 56028733AA | 2-2722-ND-2 | Chrysler | 110 |
| 54022096 | 1-2762-01LU | Marelli | 77 | 56028920AA | 1-2227-02ND-2 | Chrysler | 97 |
| 54022108 | 1-2762-01LU | Marelli | 77 | 56028920AB | 1-2390-01ND | Chrysler | 97 |
| 54022109 | 1-2762-01LU | Marelli | 77 | 56029086AA | 1-2553-01BO | Chrysler | 1 |
| 54022162 | 1-2754-02LU | Marelli | 77 | 56029113AA | 2-2327-ND | Chrysler | 108 |
| 54022178 | 1-2754-02LU | Marelli | 77 | 56029113AB | 2-2327-ND | Chrysler | 108 |
| 54022182 | 1-2762-01LU | Marelli | 77 | 56029274AA | 2-2725-MI | Chrysler | 93 |
| 54022186 | 1-2754-02LU | Marelli | 77 | 56029700AA | 1-2441-01ND | Chrysler | 97 |
| 54022188 | 1-2754-02LU | Marelli | 77 | 56029700AB | 1-2441-01ND | Chrysler | 97 |
| 54022192 | 1-2754-02LU | Marelli | 77 | 56029700AC | 1-2441-01ND | Chrysler | 97 |
| 54022211 | 1-2762-01LU | Marelli | 77 | 56029701AA | 1-2541-01BO | Chrysler | 1 |
| 54022212 | 1-2762-01LU | Marelli | 77 | 56030914AA | 1-2390-01ND | Chrysler | 97 |
| 54022214 | 1-2754-02LU | Marelli | 77 | 56030914AB | 1-2390-01ND | Chrysler | 97 |
| 54022217 | 1-2754-02LU | Marelli | 77 | 56030914AC | 1-2390-01ND | Chrysler | 97 |
| 54022218 | 1-2762-01LU | Marelli | 77 | 56041120AC | 1-2526-01BO-2 | Chrysler | 1 |
| 54022219 | 1-2762-01LU | Marelli | 77 | 56058 | 82-6852 | Western | 119 |
| 54022220 | 1-2621-01LU-2 | Marelli | 76 | 56058 | 82-6852-1 | Western | 119 |
| 54022226 | 1-2762-01LU | Lucas | 77 | 56058 | 82-6889 | Western | 120 |
| 54022227 | 1-2754-02LU | Marelli | 77 | 56062 | 82-6852 | Western | 119 |
| 54022235 | 1-2754-02LU | Marelli | 77 | 56062 | 82-6852-1 | Western | 119 |
| 54022263 | 1-2762-01LU | Marelli | 77 | 56062 | 82-6889 | Western | 120 |
| 54022280 | 1-2762-01LU | Marelli | 77 | 56133 | 82-6852 | Western | 119 |
| 54022285 | 1-2754-02LU | Marelli | 77 | 56133 | 82-6852-1 | Western | 119 |
| 54022291 | 1-2754-02LU | Marelli | 77 | 56133 | 82-6889 | Western | 120 |
| 54022295 | 1-2762-01LU | Marelli | 77 | 562202X8912 | 82-6877 | Haldex-Barnes | 118 |
| 54022309 | 1-2754-02LU | Marelli | 77 | 5686 | 82-6868-1 | Lester | 121 |
| 54022342 | 1-2754-02LU | Marelli | 77 | 5686 | 82-6868-2 | Lester | 122 |
| 54022353 | 1-2762-01LU | Marelli | 77 | 5686 | 82-6868-3 | Lester | 122 |
| 54022354 | 1-2762-01LU | Marelli | 77 | 5686 | 82-6884 | Lester | 122 |
| 54022382 | 1-2621-01LU-2 | Marelli | 76 | 5687 | 82-6868-1 | Lester | 121 |
| 54022383 | 1-2621-01LU-2 | Marelli | 76 | 5687 | 82-6868-2 | Lester | 122 |
| 54022395 | 1-2621-01LU-2 | Marelli | 76 | 5687 | 82-6868-3 | Lester | 122 |
| 54022408 | 1-2621-01LU-2 | Marelli | 76 | 5687 | 82-6884 | Lester | 122 |
| 54022415 | 1-2721-01LU | Lucas | 77 | 5702100-728 | 1-2461-01ND | Nippondenso | 94 |
| 54022443B | 1-2454-01MM | Lucas | 76 | 570-429 | 82-6876 | Raymond | 118 |
| 54022443B | 1-2454-01MM | Marelli | 76 | 570-444 | 82-6879 | Raymond | 117 |
| 54022521 | 1-2454-01MM | Lucas | 76 | 5705L1 | 1-2741-01VA | Peugeot-Citroen | 112 |
| 54022524 | 1-2730-00LU | Lucas | 77 | 5705N0 | 1-2741-01VA | Peugeot-Citroen | 112 |
| 54022527 | 1-2454-01MM | Lucas | 76 | 5705N1 | 1-2741-01VA | Peugeot-Citroen | 112 |
| 54022552 | 1-2754-02LU | Marelli | 77 | 5712800-071 | 2-2705-ND-2 | Nippondenso | 109 |
| 54022568 | 1-2454-01MM | Lucas | 76 | 571518 | 1-2614-01VA | Scania | 112 |
| 54022578 | 1-2721-01LU | Lucas | 77 | 5792 | 3-1021-FD | Lester | 60 |
| 54022669 | 1-2454-01MM | Lucas | 76 | 579-487-M91 | 2-2292-LU | Massey Ferguson | 80 |
| 54022711 | 1-2721-01LU | Lucas | 77 | 579-487-M91 | 2-2292-LU-1 | Massey Ferguson | 80 |
| 541747C91 | 50-192-1 | IHC | 43 | 579488-M91 | 2-2290-LU | Massey Ferguson | 80 |
| 541747C91 | 50-192-2 | IHC | 43 | 5802C3 | 2-2638 | Peugeot-Citroen | 93 |
| 547269C91 | 20-504-1 | IHC | 74 | 5802E2 | 2-2638 | Peugeot-Citroen | 93 |
| 551503093 | 2-2770-NK | Talbot | 94 | 5802Q5 | 2-2638 | Peugeot-Citroen | 93 |
| 56004757 | 2-1717-ND | Chrysler | 102 | 5-81100-086-0 | 2-1193-ND | Isuzu | 101 |
| 56007912 | 1-1503-06ND-2 | Chrysler | 95 | 5-81100-103-0 | 2-1734-HI | Isuzu | 70 |
| 56027221 | 1-1504-05ND-2 | Chrysler | 95 | 5-81100-118-0 | 2-2105-ND | Isuzu | 105 |
| 56027221AB | 1-2227-01ND | Chrysler | 96 | 5-81100-128-0 | 2-2231-HI | Isuzu | 71 |
| 56027221AD | 1-2389-01ND-2 | Chrysler | 97 | 5-81100-128-1 | 2-2231-HI | Isuzu | 71 |
| 56027702 | 2-1807-ND-2 | Chrysler | 104 | 5-81100-128-2 | 2-2231-HI | Isuzu | 71 |
| 56027702AB | 2-1981-ND-2 | Chrysler | 104 | 5-81100-129-0 | 2-2264-HI | Isuzu | 72 |
| 56027702AC | 2-1981-ND-2 | Chrysler | 104 | 5-81100-129-1 | 2-2264-HI | Isuzu | 72 |
| 56027703 | 2-1822-ND | Chrysler | 104 | 5-81100-129-2 | 2-2264-HI | Isuzu | 72 |
| 56027703AB | 2-1983-ND | Chrysler | 104 | 5-81100-155-0 | 2-1193-ND | Isuzu | 101 |
| 56027703AC | 2-1983-ND | Chrysler | 104 | 5-81100-166-0 | 2-1193-ND | Isuzu | 101 |
| 56027912AB | 1-2225-01ND-2 | Chrysler | 96 | 5-81100-166-1 | 2-1193-ND | Isuzu | 101 |
| 56027913 | 1-2087-01ND-2 | Chrysler | 96 | 5-81100-166-2 | 2-1193-ND | Isuzu | 101 |
| 56027913AB | 1-2227-02ND-2 | Chrysler | 97 | 5-81100-166-3 | 2-1193-ND | Isuzu | 101 |
| 56027913AC | 1-2227-02ND-2 | Chrysler | 97 | 5-81100-166-4 | 2-1193-ND | Isuzu | 101 |
| 56028237 | 1-2225-01BO | Chrysler | 1 | 5-81100-169-0 | 2-1753-ND | Isuzu | 103 |
| 56028238 | 1-2227-02BO | Chrysler | 1 | 5-81100-169-1 | 2-1753-ND | Isuzu | 103 |
| 56028238AB | 1-2227-02BO | Chrysler | 1 | 5-81100-169-2 | 2-1753-ND | Isuzu | 103 |
| 56028239 | 1-2227-01ND | Chrysler | 96 | 5-81100-174-0 | 2-1951-NK-1 | Isuzu | 93 |
| 56028560AA | 1-2541-01BO | Chrysler | 1 | 5-81100-174-2 | 2-1951-NK-1 | Isuzu | 93 |
| 56028699AA | 1-2553-01BO | Chrysler | 1 | 5-81100-183-0 | 2-1193-ND | Isuzu | 101 |
| 56028715AD | 2-2327-ND | Chrysler | 108 | 5-81100-183-1 | 2-1193-ND | Isuzu | 101 |
| 56028715AE | 2-2327-ND | Chrysler | 108 | 5-81100-192-0 | 2-1855-HI | Isuzu | 69 |
| 56028732AA | 1-2877-01BO | Chrysler | 1 | 5-81100-192-1 | 2-1855-HI | Isuzu | 69 |

CROSS REFERENCE

CROSS REFERENCE - REF# to CATALOG#

| Mfr. Part No. | Catalog No. | Mfr. Name | Pg. # | Mfr. Part No. | Catalog No. | Mfr. Name | Pg. # |
|---------------|---------------|-------------|-------|---------------|-------------|-----------|-------|
| 5-81200-330-0 | 1-2471-01HI | Isuzu | 67 | 6075 | 82-7850 | Lester | 120 |
| 5-81200-335-0 | 1-2471-01HI | Isuzu | 67 | 6078 | 82-6862 | Lester | 115 |
| 5-81200-338-1 | 1-2332-01HI | Isuzu | 66 | 6093 | 82-6879 | Lester | 117 |
| 5-81200-341-0 | 1-2332-01HI | Isuzu | 66 | 6119 | 82-6861 | Lester | 114 |
| 5-81200-341-1 | 1-2332-01HI | Isuzu | 66 | 6120 | 82-6862 | Lester | 115 |
| 5-81200-358-0 | 1-2313-01HI | Isuzu | 66 | 6121 | 82-6861 | Lester | 114 |
| 58400890 | 2-2362-BO | Lombardini | 8 | 6126 | 82-6860 | Lester | 114 |
| 585946C91 | 20-501-1 | IHC | 73 | 6126 | 82-6860-1 | Lester | 114 |
| 585947C91 | 20-501-1 | IHC | 73 | 6126 | 82-6860-2 | Lester | 114 |
| 585948C91 | 20-504-1 | IHC | 74 | 6126 | 82-6860-3 | Lester | 114 |
| 586986C91 | 20-117-1 | IHC | 11 | 6127 | 82-6860 | Lester | 114 |
| 592303 | 82-6879 | Yale | 117 | 6127 | 82-6860-1 | Lester | 114 |
| 5A6522 | 50-103-1 | Caterpillar | 41 | 6127 | 82-6860-2 | Lester | 114 |
| 5A6522 | 50-103-2 | Caterpillar | 40 | 6127 | 82-6860-3 | Lester | 114 |
| 5C3T-10300-BA | 1-2667-31FD | Ford | 59 | 6129 | 82-6876 | Lester | 118 |
| 5C3T-10300-DB | 1-2669-31FD | Ford | 59 | 6179 | 50-8429 | Lester | 32 |
| 5C3Z-10346-BA | 1-2667-31FD | Ford | 59 | 6209190 | 50-9110-1 | Volvo | 7 |
| 5C3Z-10346-DA | 1-2669-31FD | Ford | 59 | 6224 | 50-150-1 | Lester | 42 |
| 5C8661 | 20-601 | Caterpillar | 111 | 6224 | 50-150-2 | Lester | 42 |
| 5D36221G01 | 1-2436-01ND | Thermo King | 98 | 6225 | 50-150-1 | Lester | 42 |
| 5L2T-11000-AA | 2-1886-FD-1 | Ford | 63 | 6225 | 50-150-2 | Lester | 42 |
| 5L2Z-11002-AA | 2-1886-FD-1 | Ford | 63 | 6232 | 50-103-1 | Lester | 41 |
| 5L3648 | 50-111 | Caterpillar | 43 | 6232 | 50-103-2 | Lester | 40 |
| 5L3648 | 50-111-1 | Caterpillar | 43 | 6241 | 50-160-1 | Lester | 36 |
| 5L3T-10300-BA | 1-2350-11FD-2 | Ford | 58 | 6243 | 50-108-1 | Lester | 41 |
| 5L3T-10300-BB | 1-2350-11FD-2 | Ford | 58 | 6243 | 50-108-2 | Lester | 41 |
| 5L3T-10300-BC | 1-2350-11FD-2 | Ford | 58 | 6245 | 2-2675-DR | Lester | 42 |
| 5L3Z-10346-BA | 1-2350-11FD-2 | Ford | 58 | 6252 | 50-150-1 | Lester | 42 |
| 5L3Z-10346-BC | 1-2350-11FD-2 | Ford | 58 | 6252 | 50-150-2 | Lester | 42 |
| 5L4405 | 50-111 | Caterpillar | 43 | 6253 | 50-150-1 | Lester | 42 |
| 5L4405 | 50-111-1 | Caterpillar | 43 | 6253 | 50-150-2 | Lester | 42 |
| 5L4431 | 50-151-1 | Caterpillar | 42 | 6254 | 50-150-1 | Lester | 42 |
| 5L4431 | 50-151-2 | Caterpillar | 42 | 6254 | 50-150-2 | Lester | 42 |
| 5L4431 | 50-151-3 | Caterpillar | 42 | 6260 | 50-104-1 | Lester | 41 |
| 5L5353 | 50-111 | Caterpillar | 43 | 6260 | 50-104-2 | Lester | 41 |
| 5L5353 | 50-111-1 | Caterpillar | 43 | 6269 | 2-2207-DR-1 | Lester | 35 |
| 5N5692 | 20-118-1 | Caterpillar | 11 | 6292 | 50-160-1 | Lester | 36 |
| 5R3857 | 50-103-1 | Caterpillar | 41 | 6293 | 50-160-1 | Lester | 36 |
| 5R3857 | 50-103-2 | Caterpillar | 40 | 6297 | 2-2206-DR-1 | Lester | 35 |
| 5S6698 | 1-2301-00DR | Caterpillar | 17 | 6313 | 2-1413-DR | Lester | 47 |
| 600-10-75 | 50-9117 | Liebherr | 7 | 63216701 | 2-2283-BO | Marelli | 4 |
| 6-004-MA5-001 | 1-2225-01BO | Bosch | 1 | 63216702 | 2-2284-BO | Marelli | 4 |
| 6-004-ML0-002 | 1-2227-02BO | Bosch | 1 | 63216725 | 2-2283-BO | Marelli | 4 |
| 6-004-ML0-004 | 1-2227-01ND | Bosch | 96 | 63216726 | 2-2283-BO | Marelli | 4 |
| 6-004-ML0-024 | 1-2510-01BO | Bosch | 2 | 63216727 | 2-2283-BO | Marelli | 4 |
| 6-004-ML0-024 | 1-2510-01VA | Bosch | 112 | 63216731 | 2-2283-BO | Marelli | 4 |
| 6005 | 82-6888 | Lester | 117 | 63216733 | 2-2284-BO | Marelli | 4 |
| 600-813-1420 | 2-2232-ND | Komatsu | 107 | 63216740 | 50-9122-1 | Marelli | 7 |
| 600-813-2241 | 2-2828-NK | Komatsu | 94 | 63216741 | 50-9122-1 | Marelli | 7 |
| 600-813-2242 | 2-2828-NK | Komatsu | 94 | 63216747 | 2-2283-BO | Marelli | 4 |
| 600-813-2250 | 2-2828-NK | Komatsu | 94 | 63216748 | 2-2283-BO | Marelli | 4 |
| 600-813-3530 | 2-2730-NK-2 | Komatsu | 94 | 63216825 | 50-9101-1 | Marelli | 6 |
| 600-813-3630 | 2-2731-NK-2 | Komatsu | 94 | 63216826 | 50-9101-1 | Marelli | 6 |
| 600-813-3631 | 2-2731-NK-2 | Komatsu | 94 | 63216827 | 50-9101-1 | Marelli | 6 |
| 600-813-4530 | 2-2729-NK-2 | Komatsu | 94 | 63216831 | 50-9101-1 | Marelli | 6 |
| 600-813-4531 | 2-2729-NK-2 | Komatsu | 94 | 63216873 | 50-9105-1 | Marelli | 6 |
| 600-813-4532 | 2-2729-NK-2 | Komatsu | 94 | 63216896 | 50-9105-1 | Marelli | 6 |
| 600-813-4533 | 2-2729-NK-2 | Komatsu | 94 | 63216898 | 50-9105-1 | Marelli | 6 |
| 6033 | 82-6861 | Lester | 114 | 63217101 | 2-2325-BO | Marelli | 5 |
| 6034 | 82-6861 | Lester | 114 | 63217121 | 50-9900 | Marelli | 49 |
| 6035 | 82-6862 | Lester | 115 | 63217125 | 2-2325-BO | Marelli | 5 |
| 6037 | 82-6862 | Lester | 115 | 63217126 | 2-2325-BO | Marelli | 5 |
| 603853RX | 20-127-1 | Cummins | 18 | 63217201 | 50-9108 | Marelli | 6 |
| 6044 | 82-6855 | Lester | 113 | 63217225 | 50-9108 | Marelli | 6 |
| 6044 | 82-6871-1 | Lester | 116 | 63227419 | 2-2295-LU | Marelli | 78 |
| 6044-DBB | 82-6855 | Lester | 113 | 63227419 | 2-2295-LU-1 | Marelli | 78 |
| 6044-DBB | 82-6871-1 | Lester | 116 | 63227470 | 2-2302-LU | Marelli | 79 |
| 6046 | 82-6870 | Lester | 116 | 63227470 | 2-2302-LU-1 | Marelli | 79 |
| 60-5420 | 1-2391-01MI | Toro | 83 | 63227486 | 2-2301-LU | Marelli | 78 |
| 60-5421 | 1-2391-01MI | Toro | 83 | 63227487 | 2-2300-LU | Marelli | 78 |
| 60559 | 1-2462-31MD | Tennant | 82 | 63227487 | 2-2300-LU-1 | Marelli | 78 |
| 6067 | 82-6853 | Lester | 120 | 63227490 | 2-2300-LU | Marelli | 78 |

CROSS REFERENCE

CROSS REFERENCE - REF# to CATALOG#

| Mfr. Part# | Catalog# | Mfr. Name | Pg. # | Mfr. Part# | Catalog# | Mfr. Name | Pg. # |
|------------|---------------|-----------|-------|-----------------|-------------|-----------|-------|
| 63227490 | 2-2300-LU-1 | Marelli | 78 | 6492 | 2-2095-DR-2 | Lester | 46 |
| 63227554 | 2-2687-LU | Marelli | 81 | 6492 | 2-2200-DR-2 | Lester | 45 |
| 63227564 | 2-2459-LU | Marelli | 81 | 6494 | 2-2336-DR | Lester | 44 |
| 63227592 | 2-2458-LU | Marelli | 81 | 6504 | 2-1582-DR-1 | Lester | 34 |
| 63227592 | 2-2458-LU-1 | Marelli | 81 | 6505 | 50-194-1 | Lester | 37 |
| 63227601 | 2-2282-LU | Marelli | 80 | 6511 | 2-2703-DR | Lester | 42 |
| 63227604 | 2-2303-LU | Marelli | 80 | 6513 | 50-192-1 | Lester | 43 |
| 6330 | 2-1493-DR | Lester | 47 | 6513 | 50-192-2 | Lester | 43 |
| 63321285 | 1-2454-01MM | Marelli | 76 | 6516 | 2-2471-DR | Lester | 41 |
| 63321345 | 1-2454-01MM | Marelli | 76 | 6544 | 50-103-1 | Lester | 41 |
| 63321346 | 1-2454-01MM | Marelli | 76 | 6544 | 50-103-2 | Lester | 40 |
| 63321347 | 1-2455-01MM | Marelli | 73 | 6548 | 50-192-1 | Lester | 43 |
| 63321421 | 1-2454-01MM | Marelli | 76 | 6548 | 50-192-2 | Lester | 43 |
| 63321753 | 1-2455-01MM | Marelli | 73 | 6551 | 50-153-1 | Lester | 43 |
| 63324145 | 1-2754-02LU | Marelli | 77 | 6551 | 50-153-2 | Lester | 43 |
| 63324157 | 1-2762-01LU | Marelli | 77 | 6552 | 50-151-3 | Lester | 42 |
| 63324161 | 1-2754-02LU | Marelli | 77 | 6566 | 2-2471-DR | Lester | 41 |
| 63324200 | 1-2754-02LU | Marelli | 77 | 6570 | 50-8422 | Lester | 31 |
| 63324221 | 1-2754-02LU | Marelli | 77 | 6571 | 50-8403 | Lester | 29 |
| 63324276 | 1-2762-01LU | Marelli | 77 | 6572 | 50-8405 | Lester | 29 |
| 63324294 | 1-2621-01LU-2 | Marelli | 76 | 6572 | 50-8431 | Lester | 32 |
| 63340015 | 1-2454-01MM | Marelli | 76 | 6573 | 50-8407 | Lester | 30 |
| 63341285 | 1-2454-01MM | Marelli | 76 | 6573 | 50-8420 | Lester | 31 |
| 63341345 | 1-2454-01MM | Marelli | 76 | 6573 | 50-8437 | Lester | 33 |
| 6348 | 50-113-1 | Lester | 35 | 6574 | 50-8421 | Lester | 31 |
| 6352 | 50-153-1 | Lester | 43 | 6575 | 50-8410 | Lester | 30 |
| 6352 | 50-153-2 | Lester | 43 | 6576 | 50-8404 | Lester | 29 |
| 6354 | 50-160-1 | Lester | 36 | 6578 | 50-8429 | Lester | 32 |
| 6356 | 50-153-1 | Lester | 43 | 6581 | 50-8423 | Lester | 31 |
| 6356 | 50-153-2 | Lester | 43 | 6581-200-338-0 | 1-2332-01HI | Iseki | 66 |
| 6358 | 50-160-1 | Lester | 36 | 6581-200-338-0A | 1-2332-01HI | Iseki | 66 |
| 6359 | 50-160-1 | Lester | 36 | 6581-200-349-0 | 1-2332-01HI | Iseki | 66 |
| 6360 | 50-152-1 | Lester | 42 | 6582 | 50-8421 | Lester | 31 |
| 6360 | 50-152-2 | Lester | 42 | 6583 | 50-8420 | Lester | 31 |
| 63608D | 2-2286-DR | Case | 43 | 6584 | 50-8406-2 | Lester | 30 |
| 636180 | 2-2596-DR-2 | Clark | 49 | 6585 | 50-8425 | Lester | 32 |
| 6369 | 50-152-1 | Lester | 42 | 6586 | 50-8426 | Lester | 32 |
| 6369 | 50-152-2 | Lester | 42 | 6587 | 50-8431 | Lester | 32 |
| 6370 | 50-151-1 | Lester | 42 | 6588 | 50-8417 | Lester | 30 |
| 6370 | 50-151-2 | Lester | 42 | 6589 | 50-8437 | Lester | 33 |
| 6370 | 50-151-3 | Lester | 42 | 6590 | 50-8419 | Lester | 31 |
| 6371 | 50-150-1 | Lester | 42 | 6591 | 50-8424 | Lester | 31 |
| 6371 | 50-150-2 | Lester | 42 | 6592 | 50-8434 | Lester | 33 |
| 6378 | 50-151-1 | Lester | 42 | 6593 | 50-8415 | Lester | 30 |
| 6378 | 50-151-2 | Lester | 42 | 6594 | 50-8418 | Lester | 30 |
| 6378 | 50-151-3 | Lester | 42 | 6595 | 50-8428 | Lester | 32 |
| 6379 | 50-162-1 | Lester | 36 | 6597 | 50-8432 | Lester | 32 |
| 6380 | 50-162-1 | Lester | 36 | 6598 | 50-8433 | Lester | 33 |
| 6382 | 50-161-1 | Lester | 36 | 65GB-10300-LA | 1-2454-01MM | Ford | 76 |
| 6386 | 2-1584-DR-2 | Lester | 34 | 6600 | 50-8436 | Lester | 33 |
| 6387 | 50-159-1 | Lester | 36 | 6601 | 50-8438 | Lester | 33 |
| 6391 | 50-158-1 | Lester | 36 | 6603 | 2-2051-DR | Lester | 29 |
| 6392 | 50-161-1 | Lester | 36 | 6605 | 2-2770-NK | Lester | 94 |
| 6393 | 50-162-1 | Lester | 36 | 6618 | 50-150-1 | Lester | 42 |
| 6398 | 50-193-1 | Lester | 36 | 6618 | 50-150-2 | Lester | 42 |
| 6407 | 2-1474-DR-2 | Lester | 46 | 6630 | 2-2472-DR | Lester | 41 |
| 6410 | 50-159-1 | Lester | 36 | 6632415 | 2-1750-ND | Clark | 103 |
| 6412 | 50-193-1 | Lester | 36 | 6636 | 50-150-1 | Lester | 42 |
| 6416 | 2-1470-DR | Lester | 47 | 6636 | 50-150-2 | Lester | 42 |
| 6449 | 2-1690-DR-2 | Lester | 46 | 6640 | 2-1953-FD-1 | Lester | 63 |
| 6449 | 2-2143-DR-2 | Lester | 45 | 6641 | 2-1956-FD-1 | Lester | 64 |
| 6452 | 2-1912-DR-2 | Lester | 46 | 6646 | 2-1910-FD-1 | Lester | 63 |
| 6464 | 2-2470-DR | Lester | 35 | 6647 | 2-1955-FD-1 | Lester | 64 |
| 6468 | 2-1580-DR | Lester | 29 | 6651210 | 50-8429 | Bobcat | 32 |
| 6469 | 50-8402-2 | Lester | 29 | 6651664 | 50-8429 | Bobcat | 32 |
| 6482 | 2-1811-DR-2 | Lester | 46 | 6657 | 2-2218-FD | Lester | 64 |
| 6483 | 2-1796-DR | Lester | 47 | 6661611 | 1-2308-31MD | Bobcat | 82 |
| 6485 | 2-1954-DR-2 | Lester | 44 | 6669 | 2-2197-FD-2 | Lester | 61 |
| 6485 | 2-2112-DR-2 | Lester | 45 | 6670 | 2-2215-FD | Lester | 61 |
| 6488 | 2-2054-DR-2 | Lester | 44 | 6675292 | 1-2466-01MD | Bobcat | 82 |
| 6489 | 2-2054-DR-2 | Lester | 44 | 6676957 | 2-2306-MD | Bobcat | 83 |
| 6489 | 2-2211-DR-2 | Lester | 45 | 6676958 | 2-2307-MD | Bobcat | 83 |

CROSS REFERENCE - REF# to CATALOG#

| Mfr. Part No. | Catalog No. | Mfr. Name | Pg. # | Mfr. Part No. | Catalog No. | Mfr. Name | Pg. # |
|---------------|---------------|---------------|-------|---------------|---------------|---------------|-------|
| 6678205 | 1-2466-01MD | Bobcat | 82 | 6N5468 | 20-601 | Caterpillar | 111 |
| 6686 | 50-150-1 | Lester | 42 | 6N9294 | 20-118-1 | Caterpillar | 11 |
| 6686 | 50-150-2 | Lester | 42 | 703F-11000-AA | 2-2293-LU | Ford | 80 |
| 6687 | 50-150-1 | Lester | 42 | 7058 | 20-202 | Lester | 49 |
| 6687 | 50-150-2 | Lester | 42 | 70-5860 | 2-1963-MI | Toro | 89 |
| 6688 | 50-150-1 | Lester | 42 | 7069 | 20-209-9 | Lester | 50 |
| 6688 | 50-150-2 | Lester | 42 | 7072 | 20-210-1 | Lester | 50 |
| 66925090S | 2-2340-LU | Leece-Neville | 81 | 7078 | 20-202 | Lester | 49 |
| 66925090S | 2-2340-LU-1 | Leece-Neville | 81 | 7088 | 20-207-30-1 | Lester | 51 |
| 673796C92 | 50-150-1 | IHC | 42 | 7088 | 20-220-10 | Lester | 51 |
| 673796C92 | 50-150-2 | IHC | 42 | 7088 | 20-220-30 | Lester | 51 |
| 67-4630 | 1-2392-01MI | Toro | 84 | 711925 | 20-501-1 | Delco-Remy | 73 |
| 675359 | 50-161-1 | Caterpillar | 36 | 7122 | 20-101-1 | Lester | 9 |
| 6764 | 50-111 | Lester | 43 | 7127 | 20-102-1 | Lester | 10 |
| 6764 | 50-111-1 | Lester | 43 | 7127 | 20-102-5 | Lester | 10 |
| 6769 | 2-2471-DR | Lester | 41 | 7136 | 20-126-1 | Lester | 18 |
| 6779 | 50-152-1 | Lester | 42 | 7138 | 20-124-1 | Lester | 17 |
| 6779 | 50-152-2 | Lester | 42 | 714-29300R | 2-2458-LU | JCB | 81 |
| 678627 | 50-9115 | DAF | 7 | 714-29300R | 2-2458-LU-1 | JCB | 81 |
| 6801 | 2-2001-DR | Lester | 37 | 714-29500R | 2-2340-LU | JCB | 81 |
| 6802 | 2-2350-DR | Lester | 39 | 714-29500R | 2-2340-LU-1 | JCB | 81 |
| 6802 | 2-2350-DR-2 | Lester | 38 | 714-40005 | 2-2340-LU | JCB | 81 |
| 6803 | 2-2349-DR | Lester | 38 | 714-40005 | 2-2340-LU-1 | JCB | 81 |
| 6803 | 2-2349-DR-1 | Lester | 38 | 7154 | 20-104-1 | Lester | 10 |
| 6804 | 2-2347-DR-1 | Lester | 38 | 7164 | 1-2410-11DR | Lester | 9 |
| 6804 | 2-2352-DR-1 | Lester | 39 | 7164 | 1-2410-11DR-1 | Lester | 9 |
| 6806 | 2-2347-DR-1 | Lester | 38 | 7177 | 20-104-1 | Lester | 10 |
| 6807 | 2-2377-DR | Lester | 37 | 7178 | 20-104-1 | Lester | 10 |
| 6807 | 2-2377-DR-1 | Lester | 37 | 7185 | 20-104-1 | Lester | 10 |
| 6808 | 2-2372-DR | Lester | 37 | 7186 | 20-104-1 | Lester | 10 |
| 6812 | 2-2350-DR | Lester | 39 | 7197 | 20-127-1 | Lester | 18 |
| 6812 | 2-2350-DR-2 | Lester | 38 | 7199 | 20-104-1 | Lester | 10 |
| 6813 | 2-2349-DR | Lester | 38 | 7252 | 20-178-1 | Lester | 17 |
| 6813 | 2-2349-DR-1 | Lester | 38 | 7254 | 20-121-1 | Lester | 16 |
| 6814 | 2-2366-DR | Lester | 39 | 7255 | 20-119-1 | Lester | 16 |
| 6818 | 2-2353-DR-1 | Lester | 39 | 7256 | 20-133-1 | Lester | 18 |
| 6819 | 2-2345-DR-1 | Lester | 38 | 7262 | 20-131-1 | Lester | 18 |
| 6822 | 2-2367-DR | Lester | 39 | 7266 | 20-117-1 | Lester | 11 |
| 6826 | 2-2364-DR | Lester | 39 | 7282 | 20-102-1 | Lester | 10 |
| 6832 | 2-2379-DR | Lester | 37 | 7282 | 20-102-5 | Lester | 10 |
| 6833 | 2-2375-DR | Lester | 37 | 7287 | 20-116-1 | Lester | 10 |
| 6833 | 2-2375-DR-1 | Lester | 37 | 7294 | 20-110-2 | Lester | 10 |
| 683594C91 | 20-127-1 | IHC | 18 | 7297 | 20-118-1 | Lester | 11 |
| 6840 | 2-2357-DR-1 | Lester | 34 | 7305 | 20-601 | Lester | 111 |
| 6841 | 2-2704-DR-2 | Lester | 34 | 7331 | 20-601 | Lester | 111 |
| 6842 | 2-2389-DR | Lester | 34 | 7377 | 1-2836-11MO-2 | Lester | 75 |
| 6844 | 2-2391-DR | Lester | 34 | 7444 | 20-412 | Lester | 75 |
| 6849 | 2-2389-DR | Lester | 34 | 7467 | 20-118-1 | Lester | 11 |
| 6852 | 2-2348-DR | Lester | 38 | 7564 | 1-1918-00DR | Lester | 12 |
| 6853 | 2-2348-DR | Lester | 38 | 7565 | 1-1918-00DR | Lester | 12 |
| 690644C92 | 50-103-1 | IHC | 41 | 75717980 | 2-2655-ND | Lister Petter | 109 |
| 690644C92 | 50-103-2 | IHC | 40 | 75721700 | 2-2655-ND | Lister Petter | 109 |
| 690837 | 50-161-1 | Caterpillar | 36 | 75AB-10300-UA | 1-2619-01LU | Ford | 76 |
| 693F-11000-AA | 2-2293-LU | Ford | 80 | 7602 | 20-501-1 | Lester | 73 |
| 6B5539 | 50-151-1 | Caterpillar | 42 | 7608 | 20-501-1 | Lester | 73 |
| 6B5539 | 50-151-2 | Caterpillar | 42 | 7611 | 20-501-1 | Lester | 73 |
| 6B5539 | 50-151-3 | Caterpillar | 42 | 7611 | 20-502-1 | Lester | 74 |
| 6C2Z-11002-AA | 2-2215-FD | Ford | 61 | 7612 | 20-502-1 | Lester | 74 |
| 6C3T-10300-BA | 1-2667-31FD | Ford | 59 | 7613 | 20-504-1 | Lester | 74 |
| 6C3T-10300-DA | 1-2669-31FD | Ford | 59 | 7641 | 1-2333-00DR | Lester | 14 |
| 6C3Z-10346-BA | 1-2667-31FD | Ford | 59 | 7642 | 1-2291-00DR | Lester | 12 |
| 6C3Z-10346-DA | 1-2669-31FD | Ford | 59 | 7644 | 1-2299-00DR | Lester | 13 |
| 6L2Z-11002-AA | 2-1886-FD-1 | Ford | 63 | 7659 | 1-1918-00DR | Lester | 12 |
| 6L3T-10300-BA | 1-2350-11FD-2 | Ford | 58 | 7660 | 1-2333-00DR | Lester | 14 |
| 6L3Z-10346-AA | 1-2539-31FD | Ford | 59 | 7662 | 1-2297-00DR | Lester | 13 |
| 6L3Z-10346-BA | 1-2350-11FD-2 | Ford | 58 | 7662 | 1-2333-00DR | Lester | 14 |
| 6L5T-11000-AA | 2-2218-FD | Ford | 64 | 7663 | 1-2333-00DR | Lester | 14 |
| 6L5Z-11002-AA | 2-2218-FD | Ford | 64 | 7664 | 1-1915-00DR | Lester | 11 |
| 6L7Z-10346-A | 1-2539-31FD | Ford | 59 | 7664 | 1-2333-00DR | Lester | 14 |
| 6N1889 | 50-151-1 | Caterpillar | 42 | 7666 | 1-1916-00DR | Lester | 12 |
| 6N1889 | 50-151-2 | Caterpillar | 42 | 7667 | 1-1915-00DR | Lester | 11 |
| 6N1889 | 50-151-3 | Caterpillar | 42 | 7668 | 1-2333-00DR | Lester | 14 |

CROSS REFERENCE

CROSS REFERENCE - REF# to CATALOG#

| Mfr. Part# | Catalog# | Mfr. Name | Pg. # | Mfr. Part# | Catalog# | Mfr. Name | Pg. # |
|------------|---------------|-------------|-------|---------------|---------------|--------------|-------|
| 7669 | 1-2299-00DR | Lester | 13 | 7768 | 20-228-12-2 | Lester | 54 |
| 7670 | 1-1915-00DR | Lester | 11 | 7768 | 20-228-13-2 | Lester | 54 |
| 7671 | 1-1915-00DR | Lester | 11 | 7768 | 20-228-14-2 | Lester | 55 |
| 7672 | 1-2299-00DR | Lester | 13 | 7776 | 20-239-30-2 | Lester | 56 |
| 7673 | 1-2300-00DR | Lester | 14 | 7776 | 20-239-31-2 | Lester | 56 |
| 7678 | 20-1105-41 | Lester | 28 | 7778 | 20-229-31-2 | Lester | 55 |
| 7679 | 1-2334-00DR | Lester | 14 | 7778 | 20-232-10-2 | Lester | 56 |
| 7679 | 1-2334-00DR-3 | Lester | 14 | 7778 | 20-232-11-2 | Lester | 56 |
| 7680 | 1-1915-00DR | Lester | 11 | 7785 | 1-1997-11FD-2 | Lester | 52 |
| 7680 | 1-2300-00DR | Lester | 14 | 7790 | 20-244-30-2 | Lester | 56 |
| 7681 | 1-2300-00DR | Lester | 14 | 7790 | 20-244-31-2 | Lester | 57 |
| 7683 | 1-2333-00DR | Lester | 14 | 7791 | 20-239-30-2 | Lester | 56 |
| 7684 | 20-1105-41 | Lester | 28 | 7791 | 20-239-32-2 | Lester | 56 |
| 7685 | 1-2334-00DR | Lester | 14 | 7796 | 1-2173-11FD-2 | Lester | 57 |
| 7685 | 1-2334-00DR-3 | Lester | 14 | 7797 | 1-2209-11FD-2 | Lester | 58 |
| 7686 | 1-2334-00DR | Lester | 14 | 7798 | 1-2172-31FD-2 | Lester | 57 |
| 7686 | 1-2334-00DR-3 | Lester | 14 | 7799 | 1-2178-31FD-2 | Lester | 57 |
| 7687 | 20-1138-11-1 | Lester | 25 | 7802 | 20-152-11-1 | Lester | 23 |
| 769132 | 2-2471-DR | Caterpillar | 41 | 7802 | 20-152-22-1 | Lester | 23 |
| 7701003914 | 50-9115 | Renault | 7 | 7802 | 20-152-31-1 | Lester | 24 |
| 77040561 | 2-2283-BO | Fiat | 4 | 7802 | 20-152-32-1 | Lester | 24 |
| 7705 | 1-1806-12FD | Lester | 49 | 7850 | 20-125-1 | Lester | 17 |
| 77050262 | 50-9122-1 | Fiat | 7 | 7853 | 20-113-1 | Lester | 10 |
| 77050561 | 50-9108 | Fiat | 6 | 7860 | 20-142-11-1 | Lester | 22 |
| 77050562 | 50-9122-1 | Fiat | 7 | 7860 | 20-142-32-1 | Lester | 22 |
| 77065560 | 2-2284-BO | Fiat | 4 | 7861 | 20-145-11-1 | Lester | 23 |
| 77080560 | 2-2283-BO | Fiat | 4 | 7861 | 20-145-21-1 | Lester | 23 |
| 77080560 | 50-9108 | Fiat | 6 | 7861 | 20-145-31-1 | Lester | 23 |
| 77080561 | 50-9108 | Fiat | 6 | 7880 | 20-142-11-1 | Lester | 22 |
| 77097430 | 2-2284-BO | Fiat | 4 | 7880 | 20-142-32-1 | Lester | 22 |
| 7711 | 20-210-1 | Lester | 50 | 7894 | 20-152-11-1 | Lester | 23 |
| 7712 | 20-210-1 | Lester | 50 | 7894 | 20-152-22-1 | Lester | 23 |
| 77130560 | 2-2284-BO | Fiat | 4 | 7894 | 20-152-31-1 | Lester | 24 |
| 7716 | 20-208-30-1 | Lester | 51 | 78BB-10300-AA | 1-2619-01LU | Ford | 76 |
| 7716 | 20-216-10 | Lester | 50 | 78GB-10300-BA | 1-2619-01LU | Ford | 76 |
| 7716 | 20-216-30 | Lester | 50 | 7901 | 20-175-11 | Lester | 27 |
| 7732 | 20-207-30-1 | Lester | 51 | 7921 | 20-145-11-1 | Lester | 23 |
| 7732 | 20-207-31-2 | Lester | 50 | 7921 | 20-145-21-1 | Lester | 23 |
| 7732 | 20-220-10 | Lester | 51 | 7921 | 20-145-31-1 | Lester | 23 |
| 7732 | 20-220-30 | Lester | 51 | 7940 | 20-1163-1 | Lester | 19 |
| 7735 | 20-208-30-1 | Lester | 51 | 7945 | 20-189-11-1 | Lester | 24 |
| 7735 | 20-216-10 | Lester | 50 | 7960 | 20-189-11-1 | Lester | 24 |
| 7735 | 20-216-30 | Lester | 50 | 7971 | 1-1917-00DR | Lester | 12 |
| 7740560 | 2-2283-BO | Fiat | 4 | 7974 | 20-145-21-1 | Lester | 23 |
| 77414430 | 2-2283-BO | Fiat | 4 | 7975 | 20-132-1 | Lester | 18 |
| 77414431 | 2-2283-BO | Fiat | 4 | 7976 | 1-1915-00DR | Lester | 11 |
| 7744 | 20-207-30-1 | Lester | 51 | 7977 | 20-184-32 | Lester | 24 |
| 7744 | 20-220-10 | Lester | 51 | 7981 | 20-145-21-1 | Lester | 23 |
| 7744 | 20-220-30 | Lester | 51 | 7G7889 | 20-117-1 | Caterpillar | 11 |
| 77444430 | 2-2283-BO | Fiat | 4 | 7L3T-10300-AA | 1-2539-31FD | Ford | 59 |
| 77445430 | 2-2283-BO | Fiat | 4 | 7L3Z-10300-BA | 1-2350-11FD-2 | Ford | 58 |
| 7745 | 20-216-10 | Lester | 50 | 7L3Z-10346-A | 1-2539-31FD | Ford | 59 |
| 7746 | 20-219-10 | Lester | 51 | 7L3Z-10346-B | 1-2350-11FD-2 | Ford | 58 |
| 7749 | 1-1997-11FD-2 | Lester | 52 | 7L8797 | 50-151-1 | Caterpillar | 42 |
| 7749 | 20-229-10-2 | Lester | 55 | 7L8797 | 50-151-2 | Caterpillar | 42 |
| 7749 | 20-229-11-2 | Lester | 55 | 7L8797 | 50-151-3 | Caterpillar | 42 |
| 7749 | 20-229-12-2 | Lester | 55 | 7N6503 | 50-150-1 | Caterpillar | 42 |
| 7749 | 20-229-14-2 | Lester | 55 | 7N6503 | 50-150-2 | Caterpillar | 42 |
| 7749 | 20-229-31-2 | Lester | 55 | 7N8089 | 20-104-1 | Caterpillar | 10 |
| 7750 | 20-221-10-2 | Lester | 52 | 8000016 | 2-2336-DR | Delco-Remy | 44 |
| 7750 | 20-221-11-2 | Lester | 52 | 8000045 | 2-2336-DR | Delco-Remy | 44 |
| 7750 | 20-221-12-2 | Lester | 52 | 8000052 | 2-2200-DR-2 | Delco-Remy | 45 |
| 7755 | 20-225-11-2 | Lester | 53 | 8003 | 1-2291-00DR | Lester | 12 |
| 7756 | 20-226-10-2 | Lester | 53 | 8007700 | 1-2711-00BO | Iveco | 2 |
| 7756 | 20-226-11-2 | Lester | 53 | 8007700 | 1-2711-01BO | Iveco | 2 |
| 7756 | 20-226-12-2 | Lester | 53 | 8010 | 1-1916-00DR | Lester | 12 |
| 7756 | 20-226-13-2 | Lester | 53 | 8011 | 1-1915-00DR | Lester | 11 |
| 77563430 | 2-2284-BO | Fiat | 4 | 8012 | 1-1915-00DR | Lester | 11 |
| 7764 | 1-1612-33FD-2 | Lester | 52 | 8013 | 1-1915-00DR | Lester | 11 |
| 7764 | 20-227-30-2 | Lester | 54 | 8020 | 1-2334-00DR | Lester | 14 |
| 7768 | 20-228-10-2 | Lester | 54 | 8020 | 1-2334-00DR-3 | Lester | 14 |
| 7768 | 20-228-11-2 | Lester | 54 | 802010018 | 20-502-1 | Western Star | 74 |

CROSS REFERENCE

CROSS REFERENCE - REF# to CATALOG#

| Mfr. Part No. | Catalog No. | Mfr. Name | Pg. # | Mfr. Part No. | Catalog No. | Mfr. Name | Pg. # |
|---------------|---------------|--------------------|-------|---------------|---------------|-----------------|-------|
| 8021 | 1-2334-00DR | Lester | 14 | 8200024 | 2-2379-DR | Delco-Remy | 37 |
| 8021 | 1-2334-00DR-3 | Lester | 14 | 8200025 | 2-2372-DR | Delco-Remy | 37 |
| 8022 | 1-2334-00DR | Lester | 14 | 8200027 | 2-2364-DR | Delco-Remy | 39 |
| 8022 | 1-2334-00DR-3 | Lester | 14 | 8200029 | 2-2349-DR | Delco-Remy | 38 |
| 8023 | 1-2334-00DR | Lester | 14 | 8200029 | 2-2349-DR-1 | Delco-Remy | 38 |
| 8023 | 1-2334-00DR-3 | Lester | 14 | 8200032 | 2-2348-DR | Delco-Remy | 38 |
| 8026 | 1-1918-00DR | Lester | 12 | 8200033 | 2-2347-DR-1 | Delco-Remy | 38 |
| 8027 | 1-1918-00DR | Lester | 12 | 8200033 | 2-2352-DR-1 | Delco-Remy | 39 |
| 8030 | 1-2292-00DR | Lester | 12 | 8200034 | 2-2345-DR-1 | Delco-Remy | 38 |
| 8058 | 1-2429-00MO | Lester | 75 | 8200037 | 2-2350-DR | Delco-Remy | 39 |
| 8060 | 1-2301-00DR | Lester | 17 | 8200037 | 2-2350-DR-2 | Delco-Remy | 38 |
| 8066 | 1-2301-00DR | Lester | 17 | 8200039 | 2-2348-DR | Delco-Remy | 38 |
| 8070 | 1-2154-00DR | Lester | 15 | 8200040 | 2-2347-DR-1 | Delco-Remy | 38 |
| 8071 | 1-2044-00DR | Lester | 14 | 8200040 | 2-2352-DR-1 | Delco-Remy | 39 |
| 8072 | 1-2065-00DR | Lester | 15 | 8200041 | 2-2345-DR-1 | Delco-Remy | 38 |
| 8072 | 1-2065-00DR-3 | Lester | 15 | 8200043 | 2-2349-DR | Delco-Remy | 38 |
| 8073 | 1-2431-00DR-3 | Lester | 15 | 8200043 | 2-2349-DR-1 | Delco-Remy | 38 |
| 8074 | 1-2154-00DR | Lester | 15 | 8200044 | 2-2364-DR | Delco-Remy | 39 |
| 8076 | 1-2280-00DR | Lester | 15 | 8200067 | 2-2704-DR-2 | Delco-Remy | 34 |
| 8078 | 1-2065-00DR | Lester | 15 | 8200072 | 2-2375-DR | Delco-Remy | 37 |
| 8078 | 1-2065-00DR-3 | Lester | 15 | 8200072 | 2-2375-DR-1 | Delco-Remy | 37 |
| 8079 | 1-2280-00DR | Lester | 15 | 8200076 | 2-2377-DR | Delco-Remy | 37 |
| 807950 | 2-1781-MI | Clark | 88 | 8200076 | 2-2377-DR-1 | Delco-Remy | 37 |
| 8080 | 1-2077-00DR-1 | Lester | 19 | 8200078 | 2-2379-DR | Delco-Remy | 37 |
| 8081 | 1-2077-00DR-1 | Lester | 19 | 82002329 | 1-2455-01MM | New Holland | 73 |
| 8082 | 1-2057-00DR-1 | Lester | 19 | 82003307 | 1-2454-01MM | New Holland | 76 |
| 8083 | 1-2057-00DR-1 | Lester | 19 | 82010242 | 1-2454-01MM | New Holland | 76 |
| 8085 | 1-2558-00DR-1 | Lester | 19 | 82010243 | 1-2455-01MM | New Holland | 73 |
| 8090 | 1-2060-00DR-1 | Lester | 20 | 8203 | 20-1156-21 | Lester | 28 |
| 8092 | 1-2078-00DR-1 | Lester | 20 | 8206 | 1-1995-21DR-1 | Lester | 26 |
| 8094 | 1-2680-00DR | Lester | 20 | 8209 | 1-2037-21DR | Lester | 27 |
| 8096 | 1-2304-00DR-1 | Lester | 20 | 8216 | 1-2042-21DR-1 | Lester | 26 |
| 8098 | 1-2427-30DR | Lester | 11 | 8219 | 20-1156-21 | Lester | 28 |
| 8100 | 82-6869 | Monarch Hydraulics | 115 | 8227 | 1-1995-22DR | Lester | 26 |
| 8100 | 82-6869-1 | Monarch Hydraulics | 115 | 8231 | 1-2156-21DR-1 | Lester | 26 |
| 8100 | 82-6874 | Monarch Hydraulics | 116 | 8233 | 1-2175-31DR-1 | Lester | 27 |
| 8-10455-016-0 | 2-1413-DR | Isuzu | 47 | 8237 | 1-2419-21DR | Lester | 22 |
| 8-10463-034-0 | 20-142-11-1 | Isuzu | 22 | 8238 | 1-2197-21DR | Lester | 21 |
| 8-10463-034-1 | 20-142-11-1 | Isuzu | 22 | 8247 | 1-2320-21DR | Lester | 21 |
| 8-10463-407-0 | 1-1802-31DR-1 | Isuzu | 26 | 8261 | 1-2350-11FD-2 | Lester | 58 |
| 8-10463-651-0 | 1-1995-21DR-1 | Isuzu | 26 | 8262 | 1-2270-31FD-2 | Lester | 58 |
| 8-10464-084-0 | 1-2156-21DR-1 | Isuzu | 26 | 8273 | 1-2320-21DR | Lester | 21 |
| 8-10464-085-0 | 1-2175-31DR-1 | Isuzu | 27 | 8274 | 1-2419-21DR | Lester | 22 |
| 8-10464-476-0 | 1-2419-21DR | Isuzu | 22 | 8274 | 82-6866 | Warn Industries | 121 |
| 8-10465-167-0 | 2-1690-DR-2 | Isuzu | 46 | 8283 | 1-2398-11DR | Lester | 27 |
| 8-10465-462-0 | 2-1954-DR-2 | Isuzu | 44 | 8291 | 1-2320-21DR | Lester | 21 |
| 8-10465-561-0 | 2-2211-DR-2 | Isuzu | 45 | 8292 | 1-2419-21DR | Lester | 22 |
| 8111 | 82-6861 | Monarch Hydraulics | 114 | 8292 | 1-2556-21DR | Lester | 28 |
| 8111D | 82-6859 | Monarch Hydraulics | 114 | 82BB-10300-GA | 1-2754-02LU | Ford | 77 |
| 8112 | 82-6861 | Monarch Hydraulics | 114 | 8300005 | 2-2372-DR | Delco-Remy | 37 |
| 8119 | 82-6875 | Monarch Hydraulics | 118 | 8300009 | 2-2367-DR | Delco-Remy | 39 |
| 8120 | 82-6876 | Monarch Hydraulics | 118 | 8300014 | 2-2349-DR | Delco-Remy | 38 |
| 8122161 | 50-9115 | Fiat | 7 | 8300014 | 2-2349-DR-1 | Delco-Remy | 38 |
| 8126436 | 20-202 | Jeep-Eagle | 49 | 8300016 | 2-2348-DR | Delco-Remy | 38 |
| 8127023 | 20-102-1 | Jeep-Eagle | 10 | 8300019 | 2-2366-DR | Delco-Remy | 39 |
| 8131881 | 20-102-1 | Jeep-Eagle | 10 | 8300020 | 2-2350-DR | Delco-Remy | 39 |
| 8131881 | 20-102-5 | Jeep-Eagle | 10 | 8300020 | 2-2350-DR-2 | Delco-Remy | 38 |
| 8134663 | 20-102-1 | Jeep-Eagle | 10 | 8300021 | 2-2377-DR | Delco-Remy | 37 |
| 8160 | 1-1802-21DR-1 | Lester | 25 | 8300021 | 2-2377-DR-1 | Delco-Remy | 37 |
| 8160 | 1-1802-31DR-1 | Lester | 26 | 8300023 | 2-2379-DR | Delco-Remy | 37 |
| 8160 | 1-1802-42DR-1 | Lester | 26 | 8300025 | 2-2375-DR | Delco-Remy | 37 |
| 8165 | 20-1132-12-1 | Lester | 24 | 8300025 | 2-2375-DR-1 | Delco-Remy | 37 |
| 8165 | 20-1132-22-1 | Lester | 25 | 8306 | 1-2531-11FD | Lester | 59 |
| 8165 | 20-1132-33-1 | Lester | 25 | 8310 | 1-2504-31FD | Lester | 58 |
| 8166 | 20-184-32 | Lester | 24 | 8316 | 1-2511-11FD-2 | Lester | 58 |
| 8167 | 20-1142-31-1 | Lester | 25 | 8317 | 1-2512-31FD-2 | Lester | 59 |
| 81BB-10300-CA | 1-2754-02LU | Ford | 77 | 8318 | 1-2539-31FD | Lester | 59 |
| 8200000 | 2-2375-DR | Delco-Remy | 37 | 8320 | 1-2653-00LN | Lester | 74 |
| 8200000 | 2-2375-DR-1 | Delco-Remy | 37 | 8328 | 1-2429-00MO | Lester | 75 |
| 8200005 | 2-2372-DR | Delco-Remy | 37 | 8329 | 1-2564-00LN | Lester | 75 |
| 8200010 | 2-2357-DR-1 | Delco-Remy | 34 | 8349 | 1-2658-00LN | Lester | 74 |
| 8200011 | 2-2389-DR | Delco-Remy | 34 | 83505104 | 20-110-2 | Jeep-Eagle | 10 |

CROSS REFERENCE

CROSS REFERENCE - REF# to CATALOG#

| Mfr. Part# | Catalog# | Mfr. Name | Pg. # | Mfr. Part# | Catalog# | Mfr. Name | Pg. # |
|----------------|---------------|-----------------|-------|---------------|---------------|-------------|-------|
| 8361 | 1-2428-00DR-3 | Lester | 15 | 8-94333-438-0 | 2-2230-HI | Isuzu | 71 |
| 8362 | 1-2428-00DR-3 | Lester | 15 | 8-94338-096-0 | 1-2469-01HI | Isuzu | 68 |
| 8363 | 1-2662-00DR | Lester | 16 | 8-94338-847-0 | 1-2473-01HI | Isuzu | 67 |
| 8364 | 1-2663-00DR | Lester | 16 | 8-94338-847-1 | 1-2473-01HI | Isuzu | 67 |
| 8410 | 1-2532-00MO | Lester | 75 | 8-94408-365-0 | 1-1940-01HI | Isuzu | 65 |
| 8432 | 1-2678-00DR | Lester | 19 | 8-94410-409-0 | 2-2006-HI | Isuzu | 70 |
| 844-3325 | 20-412 | Thermo King | 75 | 8-94412-730-0 | 2-1193-ND | Isuzu | 101 |
| 8447 | 1-2350-11FD-2 | Lester | 58 | 8-94412-730-1 | 2-1193-ND | Isuzu | 101 |
| 845-1263 | 2-1776-HI | Thermo King | 70 | 8-94423-452-0 | 2-2100-HI | Isuzu | 71 |
| 845-1285 | 2-1734-HI | Thermo King | 70 | 8-94423-756-0 | 1-2332-01HI | Isuzu | 66 |
| 8478 | 1-2667-31FD | Lester | 59 | 8-94426-447-0 | 1-2472-01HI | Isuzu | 67 |
| 8479 | 1-2669-31FD | Lester | 59 | 8-94429-977-0 | 2-1776-HI | Isuzu | 70 |
| 8490 | 1-2415-41DR | Lester | 22 | 8-94429-978-0 | 2-1734-HI | Isuzu | 70 |
| 8492 | 1-2418-41DR | Lester | 22 | 8-94448-959-1 | 2-1193-ND | Isuzu | 101 |
| 84FB-10300-AAB | 1-2754-02LU | Ford | 77 | 8-94453-212-0 | 2-1193-HI | Isuzu | 69 |
| 8504304 | 2-2203-ND | Hyster | 106 | 8961386 | 2-2284-BO | Fiat | 4 |
| 85BB-10300-GA | 1-2754-02LU | Ford | 77 | 8962534 | 2-2284-BO | Fiat | 4 |
| 8600064 | 1-2563-00DR | Delco-Remy | 21 | 8-97023-733-1 | 1-2271-01HI | Isuzu | 65 |
| 8600065 | 1-2561-00DR | Delco-Remy | 20 | 8-97032-464-0 | 2-2233-HI | Isuzu | 71 |
| 8600066 | 1-2562-00DR | Delco-Remy | 21 | 8-97032-464-2 | 2-2233-HI | Isuzu | 71 |
| 8600112 | 1-2662-00DR | Delco-Remy | 16 | 8-97037-064-0 | 1-2470-01HI | Isuzu | 66 |
| 8600125 | 1-2682-00DR | Delco-Remy | 21 | 8-97042-997-0 | 2-2099-ND | Isuzu | 105 |
| 8607 | 1-2563-00DR | Lester | 21 | 8-97042-997-1 | 2-2099-ND | Isuzu | 105 |
| 8608 | 1-2561-00DR | Lester | 20 | 8-97042-997-2 | 2-2099-ND | Isuzu | 105 |
| 8609 | 1-2562-00DR | Lester | 21 | 8-97065-526-0 | 2-2233-HI | Isuzu | 71 |
| 8613 | 1-2682-00DR | Lester | 21 | 8-97084-877-0 | 2-2006-HI | Isuzu | 70 |
| 8624171 | 2-2596-DR-2 | Allis-Chalmers | 49 | 8-97116-697-2 | 1-2495-01HI | Isuzu | 68 |
| 8663 | 1-2655-00LN | Lester | 74 | 8-97116-697-3 | 1-2358-01HI | Isuzu | 66 |
| 86-6400 | 1-2391-01MI | Toro | 83 | 8-97118-542-0 | 2-1776-HI | Isuzu | 70 |
| 8673 | 1-2661-00LN | Lester | 75 | 8-97119-749-0 | 2-1745-ND-1 | Isuzu | 103 |
| 8674 | 1-2652-00LN | Lester | 74 | 8-97189-549-0 | 1-2496-01HI | Isuzu | 68 |
| 86AB-10300-ADA | 1-2754-02LU | Ford | 77 | 8-97189-649-0 | 1-2496-01HI | Isuzu | 68 |
| 86FB-10300-AA | 1-2754-02LU | Ford | 77 | 8-97189-650-0 | 1-2358-01HI | Isuzu | 66 |
| 86FB-10300-BA | 1-2754-02LU | Ford | 77 | 8-97209-548-3 | 2-2320-HI-1 | Isuzu | 72 |
| 8700008 | 1-2570-00DR | Delco-Remy | 16 | 8-97209-548-4 | 2-2320-HI-1 | Isuzu | 72 |
| 8700016 | 1-2563-00DR | Delco-Remy | 21 | 8972415160 | 1-2602-01VA | Isuzu | 112 |
| 8700017 | 1-2561-00DR | Delco-Remy | 20 | 8-97241-516-0 | 1-2602-01VA | Isuzu | 112 |
| 8700018 | 1-2562-00DR | Delco-Remy | 21 | 8973291631 | 2-2320-HI-1 | Isuzu | 72 |
| 8700045 | 1-2682-00DR | Delco-Remy | 21 | 8-97329-163-1 | 2-2320-HI-1 | Isuzu | 72 |
| 8706 | 1-2570-00DR | Lester | 16 | 8973828350 | 2-2320-HI-1 | Isuzu | 72 |
| 870G-10300-AA | 1-2754-02LU | Ford | 77 | 8-97382-835-0 | 2-2320-HI-1 | Isuzu | 72 |
| 878173 | 82-6879 | Clark | 117 | 8982775004 | 20-102-1 | Jeep-Eagle | 10 |
| 8796 | 82-6866 | Warn Industries | 121 | 8982775006 | 20-102-1 | Jeep-Eagle | 10 |
| 87HU-10300-AA | 20-210-1 | Ford | 50 | 8982775006 | 20-102-5 | Jeep-Eagle | 10 |
| 8-81100-253-1 | 2-2105-ND | Isuzu | 105 | 8982775013 | 2-1413-DR | Jeep-Eagle | 47 |
| 88205006 | 50-9101-1 | Fiat | 6 | 8AL2056K | 1-2836-11MO-2 | Motorola | 75 |
| 886111C91 | 50-161-1 | IHC | 36 | 8H1813 | 50-151-1 | Caterpillar | 42 |
| 8-89017-440-0 | 2-2336-DR | Isuzu | 44 | 8H1813 | 50-151-2 | Caterpillar | 42 |
| 8-89017-631-0 | 2-2336-DR | Isuzu | 44 | 8H1813 | 50-151-3 | Caterpillar | 42 |
| 89017440 | 2-2336-DR | Delco-Remy | 44 | 8H1913 | 50-151-1 | Caterpillar | 42 |
| 89-01-7440 | 2-2336-DR | Saab | 44 | 8H1913 | 50-151-2 | Caterpillar | 42 |
| 89017441 | 2-2112-DR-2 | Delco-Remy | 45 | 8H1913 | 50-151-3 | Caterpillar | 42 |
| 89017442 | 2-2200-DR-2 | Delco-Remy | 45 | 8HA2003F | 20-412 | Motorola | 75 |
| 89017630 | 2-2200-DR-2 | Delco-Remy | 45 | 8HA2003FS | 20-412 | Motorola | 75 |
| 89017631 | 2-2336-DR | Delco-Remy | 44 | 8HA2006F | 20-412 | Motorola | 75 |
| 89-01-7631 | 2-2336-DR | Saab | 44 | 8L8204 | 50-111 | Caterpillar | 43 |
| 89332 | 2-1526-ND | Versatile | 102 | 8L8204 | 50-111-1 | Caterpillar | 43 |
| 8-94123-387-0 | 2-1193-ND | Isuzu | 101 | 8L8205 | 50-111 | Caterpillar | 43 |
| 8-94133-338-0 | 2-2311-HI | Isuzu | 72 | 8L8205 | 50-111-1 | Caterpillar | 43 |
| 8-94133-338-1 | 2-2311-HI | Isuzu | 72 | 8L8206 | 50-153-1 | Caterpillar | 43 |
| 8-94136-400-0 | 2-1193-HI | Isuzu | 69 | 8L8206 | 50-153-2 | Caterpillar | 43 |
| 8-94136-400-1 | 2-1193-HI | Isuzu | 69 | 8LHA2070 | 1-2429-00MO | Motorola | 75 |
| 8-94147-549-2 | 2-1776-HI | Isuzu | 70 | 8LHA2070V | 1-2429-00MO | Motorola | 75 |
| 8-94149-249-0 | 2-1193-ND | Isuzu | 101 | 8LHA2070VA | 1-2429-00MO | Motorola | 75 |
| 8-94149-249-0 | 2-1734-HI | Isuzu | 70 | 8LHA2070VB | 1-2429-00MO | Motorola | 75 |
| 8-94151-409-0 | 2-2311-HI | Isuzu | 72 | 8LHA2070VB | 1-2429-00MO | Prestolite | 75 |
| 8-94151-409-1 | 2-2311-HI | Isuzu | 72 | 8LHA2070VBH | 1-2429-00MO | Motorola | 75 |
| 8-94175-418-0 | 1-1940-01HI | Isuzu | 65 | 8LHA2070VE | 1-2564-00LN | Motorola | 75 |
| 8-94175-448-1 | 1-1940-01HI | Isuzu | 65 | 8LHA2070VE | 1-2564-00LN | Prestolite | 75 |
| 8-94175-488-0 | 1-1940-01HI | Isuzu | 65 | 8LHA2070VGH | 1-2429-00MO | Motorola | 75 |
| 8-94332-581-1 | 1-2482-01HI | Isuzu | 67 | 8LHP2170E | 1-2665-00LN | Motorola | 76 |
| 8-94332-581-2 | 1-2482-01HI | Isuzu | 67 | 8LHP2170E | 1-2665-00LN | Prestolite | 76 |

CROSS REFERENCE - REF# to CATALOG#

| Mfr. Part No. | Catalog No. | Mfr. Name | Pg. # | Mfr. Part No. | Catalog No. | Mfr. Name | Pg. # |
|---------------|-------------|------------------------|-------|---------------|---------------|----------------|-------|
| 8LHP2170V | 1-2532-00MO | Motorola | 75 | 92497A3 | 1-2308-31MD | Mercury Marine | 82 |
| 8LHP2170V | 1-2532-00MO | Prestolite | 75 | 928805 | 2-1727-MI | Clark | 85 |
| 8LHP2170VE | 1-2665-00LN | Motorola | 76 | 929162 | 50-9108 | Fiat | 6 |
| 8LHP2170VE | 1-2665-00LN | Prestolite | 76 | 93-5907 | 1-2741-01VA | Toro | 112 |
| 8LHP2170VH | 1-2532-00MO | Motorola | 75 | 94039465 | 2-1745-ND-1 | Delco-Remy | 103 |
| 8LHP2170VH | 1-2532-00MO | Prestolite | 75 | 94052175 | 2-1745-ND-1 | Delco-Remy | 103 |
| 8N0999 | 20-178-1 | Caterpillar | 17 | 94052404 | 1-2271-01HI | Delco-Remy | 65 |
| 8N1000 | 3-1021-FD | Ford | 60 | 94123387 | 2-1193-ND | Delco-Remy | 101 |
| 8N11001 | 2-2288-FD | Ford | 61 | 943356946010 | 1-2741-01VA | Marelli | 112 |
| 8N11002 | 2-2288-FD | Ford | 61 | 94665498 | 1-2928-01DR | Delco-Remy | 28 |
| 8S9096 | 2-2220-MI | Caterpillar | 90 | 9528 | 50-103-1 | Lester | 41 |
| 9-000-083-028 | 50-9100-1 | Bosch | 5 | 9528 | 50-103-2 | Lester | 40 |
| 9-000-083-054 | 50-9100-1 | Bosch | 5 | 95VB-10300-BC | 1-2454-01MM | Ford | 76 |
| 9-000-083-071 | 2-2669-BO | Bosch | 5 | 960373 | 82-6880 | Clark | 117 |
| 9-000-143-101 | 2-2301-LU | Bosch | 78 | 9700211-029 | 1-2236-10ND | Nippondenso | 97 |
| 9-000-143-108 | 2-2301-LU | Bosch | 78 | 9700211-603 | 1-2851-01ND | Nippondenso | 100 |
| 9000719 | 2-1474-DR-2 | Delco-Remy | 46 | 9700211-605 | 1-2851-01ND | Nippondenso | 100 |
| 9000725 | 2-1474-DR-2 | Delco-Remy | 46 | 9702800-329 | 2-2276-ND | Nippondenso | 101 |
| 9000735 | 2-1474-DR-2 | Delco-Remy | 46 | 9702800-329 | 50-159-1 | Nippondenso | 36 |
| 9000786 | 2-1690-DR-2 | Delco-Remy | 46 | 9702800-381 | 2-2277-ND | Nippondenso | 101 |
| 9000812 | 2-1912-DR-2 | Delco-Remy | 46 | 9702800-397 | 2-2044-ND | Nippondenso | 100 |
| 9000834 | 2-1811-DR-2 | Delco-Remy | 46 | 9702800-525 | 2-1962-ND | Nippondenso | 100 |
| 9000841 | 2-1954-DR-2 | Delco-Remy | 44 | 9702800-840 | 2-1750-ND | Nippondenso | 103 |
| 9000842 | 2-2054-DR-2 | Delco-Remy | 44 | 9702809-588 | 2-1726-ND-2 | Nippondenso | 102 |
| 9000853 | 2-2095-DR-2 | Delco-Remy | 46 | 97082211 | 20-239-30-2 | Delco-Remy | 56 |
| 9000854 | 2-2054-DR-2 | Delco-Remy | 44 | 97082211 | 20-239-32-2 | Delco-Remy | 56 |
| 9000858 | 2-1954-DR-2 | Delco-Remy | 44 | 9712109-337 | 1-1503-01ND-2 | Nippondenso | 95 |
| 9000860 | 2-1690-DR-2 | Delco-Remy | 46 | 9712109-341 | 1-1527-02ND-2 | Nippondenso | 96 |
| 9000864 | 2-1912-DR-2 | Delco-Remy | 46 | 9712109-343 | 1-1527-02ND-2 | Nippondenso | 96 |
| 9000866 | 2-1811-DR-2 | Delco-Remy | 46 | 9712109-404 | 1-1504-01ND-2 | Nippondenso | 95 |
| 9000871 | 2-2112-DR-2 | Delco-Remy | 45 | 9712109-408 | 1-1504-05ND-2 | Nippondenso | 95 |
| 9000873 | 2-2211-DR-2 | Delco-Remy | 45 | 9712800-048 | 2-2045-ND | Nippondenso | 100 |
| 9000879 | 2-2143-DR-2 | Delco-Remy | 45 | 9712800-597 | 2-2279-ND | Nippondenso | 101 |
| 9000880 | 2-2200-DR-2 | Delco-Remy | 45 | 9712809-021 | 2-1526-ND | Nippondenso | 102 |
| 9000899 | 2-1690-DR-2 | Delco-Remy | 46 | 9712809-049 | 2-1745-ND-1 | Nippondenso | 103 |
| 9000910 | 2-2112-DR-2 | Delco-Remy | 45 | 9712809-077 | 2-2276-ND | Nippondenso | 101 |
| 9000916 | 2-2143-DR-2 | Delco-Remy | 45 | 9712809-288 | 2-1193-ND | Nippondenso | 101 |
| 9000925 | 2-2211-DR-2 | Delco-Remy | 45 | 9712809-491 | 2-1397-ND-1 | Nippondenso | 102 |
| 9000927 | 2-2200-DR-2 | Delco-Remy | 45 | 9712809-496 | 2-1383-ND-2 | Nippondenso | 102 |
| 9000939 | 2-2336-DR | Delco-Remy | 44 | 9712809-509 | 2-2709-ND-2 | Nippondenso | 110 |
| 9000962 | 2-2200-DR-2 | Delco-Remy | 45 | 9712809-527 | 2-1383-ND-2 | Nippondenso | 102 |
| 9000964 | 2-2112-DR-2 | Delco-Remy | 45 | 9712809-528 | 2-1383-ND-2 | Nippondenso | 102 |
| 9000973 | 2-2112-DR-2 | Delco-Remy | 45 | 9712809-530 | 2-2709-ND-2 | Nippondenso | 110 |
| 9002904386 | 2-1946-BO | Volvo | 7 | 9712809-572 | 2-2263-ND | Nippondenso | 107 |
| 9005408-49 | 2-1728-MI | Yale | 85 | 9712809-781 | 2-1398-ND-2 | Nippondenso | 102 |
| 9005408-56 | 2-1727-MI | Yale | 85 | 9712809-950 | 2-1526-ND | Nippondenso | 102 |
| 9005408-57 | 2-1728-MI | Yale | 85 | 971561 | 2-2596-DR-2 | Towmotor | 49 |
| 9005958-01 | 2-1729-MI | Yale | 85 | 97189650 | 1-2358-01HI | Delco-Remy | 66 |
| 9005958-24 | 2-1729-MI | Yale | 85 | 97209548 | 2-2320-HI-1 | Delco-Remy | 72 |
| 9010988-90 | 2-2024-MI | Yale | 89 | 9722800-236 | 2-2279-ND | Nippondenso | 101 |
| 9010988-91 | 2-2024-MI | Yale | 89 | 9722809-102 | 2-2107-ND | Nippondenso | 105 |
| 907381 | 82-6879 | Clark | 117 | 9722809-106 | 2-2735-ND-2 | Nippondenso | 111 |
| 911410 | 2-1781-MI | Clark | 88 | 9722809-107 | 2-1960-ND | Nippondenso | 104 |
| 9120321 | 82-6877 | Haldex-Barnes | 118 | 9722809-107 | 2-1960-ND-2 | Nippondenso | 104 |
| 9129786-00 | 2-1728-MI | Yale | 85 | 97241516 | 1-2602-01VA | Delco-Remy | 112 |
| 9-130-450-039 | 82-6880 | Wapsa | 117 | 9760211-163 | 1-2436-01ND | Nippondenso | 98 |
| 9-130-450-061 | 82-6854 | Wapsa | 113 | 9760218-454 | 1-2132-01ND | Nippondenso | 98 |
| 9-130-450-061 | 82-6854-1 | Wapsa | 113 | 9760218-454 | 1-2132-01ND-2 | Nippondenso | 98 |
| 9-130-450-064 | 82-6854 | Wapsa | 113 | 97720446 | 2-2320-HI-1 | Delco-Remy | 72 |
| 9-130-450-064 | 82-6854-1 | Wapsa | 113 | 97729079 | 2-2320-HI-1 | Delco-Remy | 72 |
| 9-130-450-081 | 82-6854 | Wapsa | 113 | 98-9474 | 1-2478-01ND | Toro | 99 |
| 9-130-450-081 | 82-6854-1 | Wapsa | 113 | 989969C91 | 50-151-1 | IHC | 42 |
| 916303 | 2-2596-DR-2 | Clark | 49 | 989969C91 | 50-151-2 | IHC | 42 |
| 9181396-00 | 2-1728-MI-3 | Yale | 92 | 989969C91 | 50-151-3 | IHC | 42 |
| 918306 | 2-1612-MI | Clark | 88 | 98AB-10300-FC | 1-2350-11FD-2 | Ford | 58 |
| 918306 | 2-1612-MI-2 | Clark | 88 | 98AZ-10346-FA | 1-2350-11FD-2 | Ford | 58 |
| 91902C1 | 2-2710-ND-2 | Case | 101 | 99451753 | 2-2463-BO | Iveco | 8 |
| 91920-04200 | 1-2467-01MD | Mitsubishi Caterpillar | 82 | 997870R91 | 2-2286-DR | IHC | 43 |
| 920670 | 2-2102-MI | Clark | 90 | 9G9538 | 20-121-1 | Caterpillar | 16 |
| 920971 | 2-1996-MI | Clark | 92 | 9L3597 | 50-150-1 | Caterpillar | 42 |
| 92134 | 50-9900 | Electroprecizia | 49 | 9L3597 | 50-150-2 | Caterpillar | 42 |
| 921615 | 2-1996-MI | Clark | 92 | 9L5938 | 20-124-1 | Caterpillar | 17 |

CROSS REFERENCE

CROSS REFERENCE - REF# to CATALOG#

| Mfr. Part# | Catalog# | Mfr. Name | Pg. # | Mfr. Part# | Catalog# | Mfr. Name | Pg. # |
|-------------|-------------|---------------|-------|--------------|-------------|------------|-------|
| 9L6474 | 50-111 | Caterpillar | 43 | ANB-7003 | 20-601 | Prestolite | 111 |
| 9L6474 | 50-111-1 | Caterpillar | 43 | ANB-7004 | 20-601 | Prestolite | 111 |
| 9M1662 | 50-152-1 | Caterpillar | 42 | AR150CA | 1-2308-31MD | Mando | 82 |
| 9M1662 | 50-152-2 | Caterpillar | 42 | AR150DA | 1-2308-31MD | Mando | 82 |
| 9N10000 | 3-1021-FD | Ford | 60 | AR41627 | 2-2276-ND | John Deere | 101 |
| 9N-10002-C | 3-1021-FD | Ford | 60 | AR46886 | 2-2277-ND | John Deere | 101 |
| 9N11001 | 2-2288-FD | Ford | 61 | AR62154 | 2-2277-ND | John Deere | 101 |
| 9N11002 | 2-2288-FD | Ford | 61 | AR63341 | 2-2044-ND | John Deere | 100 |
| 9S4870 | 20-601 | Caterpillar | 111 | AR87204 | 1-2236-10ND | John Deere | 97 |
| 9W1082 | 20-125-1 | Caterpillar | 17 | AR87205 | 1-2236-10ND | John Deere | 97 |
| 9W2946 | 2-2263-ND | Caterpillar | 107 | AR93447 | 1-2236-10ND | John Deere | 97 |
| A000B0431 | 1-2308-31MD | Mando | 82 | AR93448 | 1-2236-10ND | John Deere | 97 |
| A000B0471K | 1-2462-31MD | Mando | 82 | AT103789 | 1-2236-10ND | John Deere | 97 |
| A001090752 | 20-502-1 | Leece-Neville | 74 | AT220394 | 1-2344-00BO | John Deere | 2 |
| A0014800JB | 1-2655-00LN | Leece-Neville | 74 | AZF4507 | 2-2770-NK | Iskra | 94 |
| A0014833LGH | 1-2661-00LN | Leece-Neville | 75 | AZF4611 | 2-2666 | Iskra | 109 |
| A0014834LC | 1-2658-00LN | Leece-Neville | 74 | AZJ0501 | 2-2297-BO | Iskra | 4 |
| A0014836AAH | 1-2652-00LN | Leece-Neville | 74 | AZJ3115 | 50-9900 | Iskra | 49 |
| A0T25371 | 1-2392-01MI | Mitsubishi | 84 | AZJ3131 | 50-9122-1 | Iskra | 7 |
| A0T25471 | 1-2392-01MI | Mitsubishi | 84 | AZJ3132 | 50-9110-1 | Iskra | 7 |
| A11VI45 | 1-2741-01VA | Valeo | 112 | AZJ3133 | 2-2283-BO | Iskra | 4 |
| A14N104 | 1-2614-01VA | Valeo | 112 | AZJ3169 | 50-9124-1 | Iskra | 7 |
| A14N138 | 1-2614-01VA | Valeo | 112 | AZJ3195 | 50-9900 | Iskra | 49 |
| A14N160 | 1-2614-01VA | Valeo | 112 | AZJ3516 | 50-9900 | Iskra | 49 |
| A14N205 | 1-2614-01VA | Valeo | 112 | AZJ3518 | 50-9110-1 | Iskra | 7 |
| A162469 | 2-2710-ND-2 | Case | 101 | AZJ3534 | 50-9900 | Iskra | 49 |
| A170746 | 2-1526-ND | Case | 102 | AZJ3535 | 50-9101-1 | Iskra | 6 |
| A187623 | 1-2344-00BO | Case | 2 | AZJ3538 | 2-2325-BO | Iskra | 5 |
| A187728 | 2-2710-ND-2 | Case | 101 | AZJ3548 | 50-9100-1 | Iskra | 5 |
| A1T22971 | 1-1112-01 | Mitsubishi | 65 | AZJ3582 | 50-9101-1 | Iskra | 6 |
| A1T25077 | 1-2391-01MI | Mitsubishi | 83 | AZJ3594 | 50-9105-1 | Iskra | 6 |
| A1T25083 | 1-2391-01MI | Mitsubishi | 83 | C0DF-11001-A | 2-1674-FD | Ford | 60 |
| A2T36776 | 1-2438-01MI | Mitsubishi | 84 | C0DF-11001-D | 2-1674-FD | Ford | 60 |
| A2T38776 | 1-2438-01MI | Mitsubishi | 84 | C1AF-11001-C | 2-1674-FD | Ford | 60 |
| A2TA2871 | 1-2153-01MI | Mitsubishi | 84 | C1VF-11001-D | 2-1674-FD | Ford | 60 |
| A2TA2871A | 1-2153-01MI | Mitsubishi | 84 | C2OZ-11002-B | 2-1668-FD | Ford | 60 |
| A3T03471 | 1-2479-01MI | Mitsubishi | 84 | C2VF-11001-C | 2-1674-FD | Ford | 60 |
| A44794 | 20-601 | Case | 111 | C2VY-11002-A | 2-1674-FD | Ford | 60 |
| A449934Z | 2-2287-DR | Case | 44 | C3NF-11001-A | 2-2289-FD | Ford | 61 |
| A47434 | 20-601 | Case | 111 | C3NF-11002-D | 2-2289-FD | Ford | 61 |
| A47496 | 2-1726-ND-2 | Case | 102 | C3OF-11001-B | 2-1674-FD | Ford | 60 |
| A49652 | 20-127-1 | Case | 18 | C3OZ-11002-C | 2-1674-FD | Ford | 60 |
| A7T03277 | 1-1960-01MI | Mitsubishi | 84 | C3VF-11001-A | 2-1674-FD | Ford | 60 |
| A7T03277A | 1-1960-01MI | Mitsubishi | 84 | C4OF-11001-B | 2-1674-FD | Ford | 60 |
| A7T03371 | 1-2062-01MI | Mitsubishi | 84 | C4TF-11001-B | 2-1674-FD | Ford | 60 |
| A7T03371A | 1-2062-01MI | Mitsubishi | 84 | C4TZ-11002-B | 2-1674-FD | Ford | 60 |
| A7T03371AC | 1-2062-01MI | Mitsubishi | 84 | C4VF-11001-A | 2-1674-FD | Ford | 60 |
| A7T03877 | 1-2480-01MI | Mitsubishi | 85 | C5AF-10300-A | 20-202 | Ford | 49 |
| A8TU0091 | 1-1929-01MI | Mitsubishi | 83 | C5AF-10300-B | 20-202 | Ford | 49 |
| AAK5354 | 1-2455-01MM | Iskra | 73 | C5AF-10300-C | 20-202 | Ford | 49 |
| AC155513 | 1-2308-31MD | Mando | 82 | C5AF-10300-D | 20-202 | Ford | 49 |
| AC155515 | 1-2462-31MD | Mando | 82 | C5AF-10300-E | 20-202 | Ford | 49 |
| AC155515 | 1-2462-31MD | Valeo | 82 | C5AF-10300-F | 20-202 | Ford | 49 |
| AELB710 | 1-2721-01LU | DAF | 77 | C5AF-10300-G | 20-202 | Ford | 49 |
| AJU1957 | 1-2619-01LU | Rover | 76 | C5AF-10346-A | 20-202 | Ford | 49 |
| AL39700 | 2-1803-BO-2 | John Deere | 4 | C5AF-11001-A | 2-1674-FD | Ford | 60 |
| AL41247 | 2-1803-BO-2 | John Deere | 4 | C5AZ-10346-A | 20-202 | Ford | 49 |
| AL60033 | 1-2435-01BO | John Deere | 73 | C5DF-10300-A | 20-202 | Ford | 49 |
| AL62690 | 2-1803-BO-2 | John Deere | 4 | C5DF-10300-B | 20-202 | Ford | 49 |
| AL62772 | 2-1803-BO-2 | John Deere | 4 | C5DF-10346-A | 20-202 | Ford | 49 |
| AL67176 | 1-2435-01BO | John Deere | 73 | C5DF-10346-B | 20-202 | Ford | 49 |
| AL78690 | 1-2435-01BO | John Deere | 73 | C5DZ-10346-A | 20-202 | Ford | 49 |
| AL81437 | 1-2435-01BO | John Deere | 73 | C5DZ-10346-B | 20-202 | Ford | 49 |
| AM877285 | 2-2705-ND-2 | John Deere | 109 | C5NF-10000-E | 3-1005-01LU | Ford | 77 |
| AM878581 | 1-2315-01 | John Deere | 68 | C5TF-10300-A | 20-202 | Ford | 49 |
| AMJ4680 | 82-6863 | Iskra | 115 | C5TF-10300-B | 20-202 | Ford | 49 |
| AMJ4739 | 82-6882 | Iskra | 120 | C5TF-10300-C | 20-202 | Ford | 49 |
| AMJ5667 | 82-7860 | Iskra | 118 | C5TF-10300-D | 20-202 | Ford | 49 |
| ANB-6002 | 20-601 | Prestolite | 111 | C5TF-10300-E | 20-202 | Ford | 49 |
| ANB-6004 | 20-601 | Prestolite | 111 | C5TF-10300-F | 20-202 | Ford | 49 |
| ANB-7001 | 20-601 | Prestolite | 111 | C5TF-10300-H | 20-202 | Ford | 49 |
| ANB-7002 | 20-601 | Prestolite | 111 | C5TF-10300-J | 20-202 | Ford | 49 |

CROSS REFERENCE

CROSS REFERENCE - REF# to CATALOG#

| Mfr. Part No. | Catalog No. | Mfr. Name | Pg. # | Mfr. Part No. | Catalog No. | Mfr. Name | Pg. # |
|---------------|-------------|-----------|-------|---------------|-------------|------------|-------|
| C5TF-10300-Z | 20-202 | Ford | 49 | C9AF-11001-B | 2-1674-FD | Ford | 60 |
| C5TF-10346-A | 20-202 | Ford | 49 | C9SF-10300-A | 20-202 | Ford | 49 |
| C5TF-10346-B | 20-202 | Ford | 49 | C9ZF-10300-A | 20-202 | Ford | 49 |
| C5TF-10346-G | 20-202 | Ford | 49 | C9ZF-10300-B | 20-202 | Ford | 49 |
| C5TF-10346-H | 20-202 | Ford | 49 | C9ZF-10300-C | 20-202 | Ford | 49 |
| C5TZ-10346-A | 20-202 | Ford | 49 | C9ZZ-10346-B | 20-202 | Ford | 49 |
| C5TZ-10346-B | 20-202 | Ford | 49 | CH10493 | 1-2461-01ND | John Deere | 94 |
| C5TZ-10346-G | 20-202 | Ford | 49 | CH12741 | 2-2705-ND-2 | John Deere | 109 |
| C5TZ-10346-H | 20-202 | Ford | 49 | CH19284 | 2-2705-ND-2 | John Deere | 109 |
| C6AF-10300-A | 20-202 | Ford | 49 | D0AF-10300-C | 20-202 | Ford | 49 |
| C6AF-10300-B | 20-202 | Ford | 49 | D0AF-10300-E | 20-202 | Ford | 49 |
| C6AF-10300-C | 20-202 | Ford | 49 | D0AF-10300-F | 20-202 | Ford | 49 |
| C6AF-10300-D | 20-202 | Ford | 49 | D0AF-10300-G | 20-202 | Ford | 49 |
| C6AF-10300-E | 20-202 | Ford | 49 | D0AF-10300-H | 20-202 | Ford | 49 |
| C6AF-10300-F | 20-202 | Ford | 49 | D0AF-10346-C | 20-202 | Ford | 49 |
| C6AF-10300-G | 20-202 | Ford | 49 | D0AF-10346-E | 20-202 | Ford | 49 |
| C6AF-10346-B | 20-202 | Ford | 49 | D0AF-10346-F | 20-202 | Ford | 49 |
| C6AF-11001-A | 2-1674-FD | Ford | 60 | D0AF-11001-A | 2-1674-FD | Ford | 60 |
| C6AZ-11002-A | 2-1674-FD | Ford | 60 | D0AF-11001-E | 2-1674-FD | Ford | 60 |
| C6DF-10300-A | 20-202 | Ford | 49 | D0AZ-10346-E | 20-202 | Ford | 49 |
| C6DF-10300-B | 20-202 | Ford | 49 | D0AZ-10346-F | 20-202 | Ford | 49 |
| C6DF-10300-C | 20-202 | Ford | 49 | D0HF-10300-D | 20-202 | Ford | 49 |
| C6DF-10346-A | 20-202 | Ford | 49 | D0LF-10300-H | 20-202 | Ford | 49 |
| C6GF-10300-A | 20-202 | Ford | 49 | D0OF-11001-A | 2-1674-FD | Ford | 60 |
| C6GF-10300-B | 20-202 | Ford | 49 | D0SF-10300-A | 20-202 | Ford | 49 |
| C6TF-10300-A | 20-202 | Ford | 49 | D0TF-10300-C | 20-202 | Ford | 49 |
| C6TF-10300-B | 20-202 | Ford | 49 | D0TF-10300-D | 20-202 | Ford | 49 |
| C6TF-10300-C | 20-202 | Ford | 49 | D0TF-10300-E | 20-202 | Ford | 49 |
| C6TF-10300-D | 20-202 | Ford | 49 | D0TF-10300-F | 20-202 | Ford | 49 |
| C6TF-10300-E | 20-202 | Ford | 49 | D0TF-10300-G | 20-202 | Ford | 49 |
| C6TF-10300-F | 20-202 | Ford | 49 | D0TF-10300-J | 20-202 | Ford | 49 |
| C6TF-10300-G | 20-202 | Ford | 49 | D0TF-10300-K | 20-202 | Ford | 49 |
| C6TF-10300-H | 20-202 | Ford | 49 | D0TF-10346-B | 20-202 | Ford | 49 |
| C6TF-10300-J | 20-202 | Ford | 49 | D0TF-10346-C | 20-202 | Ford | 49 |
| C6TF-10300-K | 20-202 | Ford | 49 | D0TF-11001-A | 2-1674-FD | Ford | 60 |
| C6TF-10300-L | 20-202 | Ford | 49 | D0TZ-10346-C | 20-202 | Ford | 49 |
| C6TF-10300-M | 20-202 | Ford | 49 | D0UF-10300-A | 20-202 | Ford | 49 |
| C6TF-10346-A | 20-202 | Ford | 49 | D0ZF-10300-A | 20-202 | Ford | 49 |
| C6TF-10346-B | 20-202 | Ford | 49 | D0ZF-10300-B | 20-202 | Ford | 49 |
| C6TF-10346-C | 20-202 | Ford | 49 | D0ZF-10300-C | 20-202 | Ford | 49 |
| C6TF-10346-D | 20-202 | Ford | 49 | D0ZF-10346-B | 20-202 | Ford | 49 |
| C6TF-11000-C | 50-108-1 | Ford | 41 | D0ZZ-10346-B | 20-202 | Ford | 49 |
| C6TF-11000-C | 50-108-2 | Ford | 41 | D129494 | 2-1751-ND-2 | Case | 103 |
| C6VF-10300-A | 20-202 | Ford | 49 | D1AF-10300-AA | 20-202 | Ford | 49 |
| C6VF-10346-A | 20-202 | Ford | 49 | D1ZF-10300-AA | 20-202 | Ford | 49 |
| C6VF-10346-B | 20-202 | Ford | 49 | D20F-10300-CB | 20-202 | Ford | 49 |
| C6VF-11001-A | 2-1674-FD | Ford | 60 | D20F-10300-EB | 20-202 | Ford | 49 |
| C6VF-11002-A | 2-1674-FD | Ford | 60 | D22F-10300-BA | 20-202 | Ford | 49 |
| C6VY-10346-A | 20-202 | Ford | 49 | D2AF-10300-AA | 20-202 | Ford | 49 |
| C6VY-11002-A | 2-1674-FD | Ford | 60 | D2AF-10300-AB | 20-202 | Ford | 49 |
| C6VY-11002-B | 2-1674-FD | Ford | 60 | D2AF-10300-BA | 20-202 | Ford | 49 |
| C7AF-11001-A | 2-1674-FD | Ford | 60 | D2AF-10300-BB | 20-202 | Ford | 49 |
| C7AF-11001-C | 2-1674-FD | Ford | 60 | D2AF-10300-CA | 20-202 | Ford | 49 |
| C7AF-11001-E | 2-1674-FD | Ford | 60 | D2AF-10300-CB | 20-202 | Ford | 49 |
| C7NN-10000-A | 3-1005-01LU | Ford | 77 | D2AF-10346-CA | 20-202 | Ford | 49 |
| C7NN-10000-C | 3-1005-01LU | Ford | 77 | D2AF-10346-DA | 20-202 | Ford | 49 |
| C7NN-10000-D | 3-1005-01LU | Ford | 77 | D2AF-11001-BA | 2-1674-FD | Ford | 60 |
| C7OF-11001-A | 2-1674-FD | Ford | 60 | D2AF-11001-CA | 2-1668-FD | Ford | 60 |
| C7SF-10300-A | 20-202 | Ford | 49 | D2AF-11001-HA | 2-1668-FD | Ford | 60 |
| C7SF-10300-B | 20-202 | Ford | 49 | D2AZ-10346-C | 20-202 | Ford | 49 |
| C7TF-10300-C | 20-202 | Ford | 49 | D2AZ-10346-D | 20-202 | Ford | 49 |
| C7TF-10300-D | 20-202 | Ford | 49 | D2DF-10300-AB | 20-202 | Ford | 49 |
| C7TF-10300-E | 20-202 | Ford | 49 | D2DF-10300-AC | 20-202 | Ford | 49 |
| C7TF-11001-B | 2-1674-FD | Ford | 60 | D2HF-10300-AA | 20-202 | Ford | 49 |
| C7ZF-10300-A | 20-202 | Ford | 49 | D2HF-10300-AB | 20-202 | Ford | 49 |
| C8AF-11001-A | 2-1674-FD | Ford | 60 | D2HF-10300-AC | 20-202 | Ford | 49 |
| C8AZ-11002-A | 2-1674-FD | Ford | 60 | D2OF-10300-BA | 20-202 | Ford | 49 |
| C8TF-11000-C | 50-100-1 | Ford | 40 | D2OF-10300-BB | 20-202 | Ford | 49 |
| C8TF-11000-C | 50-100-2 | Ford | 40 | D2OF-10300-CA | 20-202 | Ford | 49 |
| C9AF-10300-A | 20-202 | Ford | 49 | D2OF-10300-CB | 20-202 | Ford | 49 |
| C9AF-10300-B | 20-202 | Ford | 49 | D2OF-10300-DA | 20-202 | Ford | 49 |
| C9AF-10300-C | 20-202 | Ford | 49 | D2OF-10300-DB | 20-202 | Ford | 49 |

CROSS REFERENCE

CROSS REFERENCE - REF# to CATALOG#

| Mfr. Part# | Catalog# | Mfr. Name | Pg. # | Mfr. Part# | Catalog# | Mfr. Name | Pg. # |
|---------------|-----------|-----------|-------|---------------|---------------|---------------|-------|
| D2OF-10300-EA | 20-202 | Ford | 49 | D4HZ-10346-N | 20-501-1 | Ford | 73 |
| D2OF-10300-EB | 20-202 | Ford | 49 | D4LF-10300-AA | 20-202 | Ford | 49 |
| D2OF-10300-FA | 20-202 | Ford | 49 | D4LF-10300-BA | 20-202 | Ford | 49 |
| D2OF-10300-FB | 20-202 | Ford | 49 | D4LF-10300-CA | 20-202 | Ford | 49 |
| D2OF-10346-CA | 20-202 | Ford | 49 | D4LF-10300-DA | 20-202 | Ford | 49 |
| D2OF-10346-DA | 20-202 | Ford | 49 | D4NN-11000-B | 50-9200 | Ford | 82 |
| D2OF-10346-GA | 20-202 | Ford | 49 | D4NN-11000-B | 50-9200-1 | Ford | 82 |
| D2OF-11001-AA | 2-1674-FD | Ford | 60 | D4NN-11000-B | 50-9200-2 | Ford | 82 |
| D2OF-11001-BA | 2-1674-FD | Ford | 60 | D4OF-10300-AA | 20-202 | Ford | 49 |
| D2SF-10300-AA | 20-202 | Ford | 49 | D4OF-10300-BA | 20-202 | Ford | 49 |
| D2SF-10300-AB | 20-202 | Ford | 49 | D4OF-10300-CA | 20-202 | Ford | 49 |
| D2TF-10300-AA | 20-202 | Ford | 49 | D4OF-10300-DA | 20-202 | Ford | 49 |
| D2TF-10300-AB | 20-202 | Ford | 49 | D4OF-10300-DF | 20-202 | Ford | 49 |
| D2TF-10300-AC | 20-202 | Ford | 49 | D4OF-10300-FA | 20-202 | Ford | 49 |
| D2TF-10300-BA | 20-202 | Ford | 49 | D4OF-10346-AA | 20-202 | Ford | 49 |
| D2TF-10300-BB | 20-202 | Ford | 49 | D4OF-10346-BA | 20-202 | Ford | 49 |
| D2TF-10300-BC | 20-202 | Ford | 49 | D4OF-10346-CA | 20-202 | Ford | 49 |
| D2TF-10300-BD | 20-202 | Ford | 49 | D4OZ-10346-A | 20-202 | Ford | 49 |
| D2TF-10300-CB | 20-202 | Ford | 49 | D4OZ-10346-B | 20-202 | Ford | 49 |
| D2TF-10300-CC | 20-202 | Ford | 49 | D4OZ-10346-C | 20-202 | Ford | 49 |
| D2TF-10300-DA | 20-202 | Ford | 49 | D4OZ-11002-A | 2-1668-FD | Ford | 60 |
| D2TF-10300-DB | 20-202 | Ford | 49 | D4TF-10300-AA | 20-202 | Ford | 49 |
| D2TF-10300-DC | 20-202 | Ford | 49 | D4UF-10300-AA | 20-202 | Ford | 49 |
| D2TF-10300-EA | 20-202 | Ford | 49 | D4ZF-10300-AA | 20-202 | Ford | 49 |
| D2TF-10300-EB | 20-202 | Ford | 49 | D52F-10300-AA | 20-202 | Ford | 49 |
| D2TF-10300-EC | 20-202 | Ford | 49 | D562202X8912 | 82-6877 | Haldex-Barnes | 118 |
| D2TF-10346-BA | 20-202 | Ford | 49 | D562275X8375 | 82-6877 | Haldex-Barnes | 118 |
| D2TF-11001-AA | 2-1674-FD | Ford | 60 | D5AF-10300-AA | 20-202 | Ford | 49 |
| D2TF-11001-BA | 2-1674-FD | Ford | 60 | D5AF-10300-BA | 20-202 | Ford | 49 |
| D2TZ-10346-B | 20-202 | Ford | 49 | D5AF-10300-CA | 20-202 | Ford | 49 |
| D2TZ-10346-BA | 20-202 | Ford | 49 | D5AF-10300-DA | 20-202 | Ford | 49 |
| D2UF-10300-AA | 20-202 | Ford | 49 | D5AF-10300-EA | 20-202 | Ford | 49 |
| D2UF-10300-AB | 20-202 | Ford | 49 | D5AF-10300-FA | 20-202 | Ford | 49 |
| D2UF-10300-AC | 20-202 | Ford | 49 | D5AF-10300-GA | 20-202 | Ford | 49 |
| D2ZF-10300-AB | 20-202 | Ford | 49 | D5AF-10300-HA | 20-202 | Ford | 49 |
| D2ZF-10300-AC | 20-202 | Ford | 49 | D5AF-10300-JA | 20-202 | Ford | 49 |
| D2ZF-10300-BA | 20-202 | Ford | 49 | D5AF-10300-KA | 20-202 | Ford | 49 |
| D2ZF-10300-BB | 20-202 | Ford | 49 | D5AF-10300-LA | 20-202 | Ford | 49 |
| D2ZF-10346-BA | 20-202 | Ford | 49 | D5AF-10346-BA | 20-202 | Ford | 49 |
| D30F-10300-BA | 20-202 | Ford | 49 | D5AZ-10346-A | 20-202 | Ford | 49 |
| D32F-10300-BA | 20-202 | Ford | 49 | D5AZ-10346-B | 20-202 | Ford | 49 |
| D3DF-10300-AA | 20-202 | Ford | 49 | D5AZ-10346-C | 20-202 | Ford | 49 |
| D3DF-10300-CA | 20-202 | Ford | 49 | D5NN-10300-A | 1-2836-11MO-2 | Ford | 75 |
| D3HF-10300-AA | 20-209-9 | Ford | 50 | D5NN-10300-BA | 1-2836-11MO-2 | Ford | 75 |
| D3HF-10300-DA | 20-202 | Ford | 49 | D5NN-10300-D | 1-2836-11MO-2 | Ford | 75 |
| D3OF-10300-BA | 20-202 | Ford | 49 | D5OF-11001-AA | 2-1668-FD | Ford | 60 |
| D3OF-10300-CA | 20-202 | Ford | 49 | D5OF-11001-BA | 2-1668-FD | Ford | 60 |
| D3OF-10300-EA | 20-202 | Ford | 49 | D6BF-11001-BA | 2-1674-FD | Ford | 60 |
| D3OF-10300-FA | 20-202 | Ford | 49 | D6DZ-11002-B | 2-1674-FD | Ford | 60 |
| D3TF-10300-BA | 20-202 | Ford | 49 | D6FF-10300-BA | 20-202 | Ford | 49 |
| D3TF-10300-CA | 20-202 | Ford | 49 | D6FF-10300-CA | 20-202 | Ford | 49 |
| D3TF-10300-DA | 20-202 | Ford | 49 | D6FF-10300-DA | 20-202 | Ford | 49 |
| D3UF-10300-AA | 20-202 | Ford | 49 | D6OF-11001-AA | 2-1668-FD | Ford | 60 |
| D3ZF-10300-AA | 20-202 | Ford | 49 | D6OZ-11002-A | 2-1668-FD | Ford | 60 |
| D40F-10300-BA | 20-202 | Ford | 49 | D6TF-11001-AA | 2-1674-FD | Ford | 60 |
| D40F-10300-DA | 20-202 | Ford | 49 | D6TF-11001-BA | 2-1674-FD | Ford | 60 |
| D42F-10300-AA | 20-202 | Ford | 49 | D6TF-11001-EA | 2-1674-FD | Ford | 60 |
| D42F-10300-BA | 20-202 | Ford | 49 | D6TZ-11002-A | 2-1674-FD | Ford | 60 |
| D42F-10300-DA | 20-202 | Ford | 49 | D6TZ-11002-B | 2-1674-FD | Ford | 60 |
| D42F-10300-EA | 20-202 | Ford | 49 | D7AF-10300-AA | 20-202 | Ford | 49 |
| D42F-10300-FA | 20-202 | Ford | 49 | D7AF-10300-BA | 20-202 | Ford | 49 |
| D4AF-10346-AA | 20-202 | Ford | 49 | D7AF-10300-CA | 20-202 | Ford | 49 |
| D4DF-10300-AA | 20-202 | Ford | 49 | D7AF-10300-DA | 20-202 | Ford | 49 |
| D4HF-10300-A | 20-119-1 | Ford | 16 | D7AF-10300-EA | 20-202 | Ford | 49 |
| D4HF-10300-AA | 20-119-1 | Ford | 16 | D7AF-10300-FA | 20-202 | Ford | 49 |
| D4HF-10300-BA | 20-209-9 | Ford | 50 | D7AF-10300-GA | 20-202 | Ford | 49 |
| D4HF-10300-C | 20-119-1 | Ford | 16 | D7AF-10300-HA | 20-202 | Ford | 49 |
| D4HF-10346-BA | 20-209-9 | Ford | 50 | D7AF-10300-JA | 20-202 | Ford | 49 |
| D4HF-10346-C | 20-119-1 | Ford | 16 | D7AF-10300-KA | 20-202 | Ford | 49 |
| D4HF-10346-CA | 20-119-1 | Ford | 16 | D7AF-10300-LA | 20-202 | Ford | 49 |
| D4HZ-10346-A | 20-119-1 | Ford | 16 | D7AF-10346-AA | 20-202 | Ford | 49 |
| D4HZ-10346-B | 20-209-9 | Ford | 50 | D7AF-10346-BA | 20-202 | Ford | 49 |

CROSS REFERENCE

CROSS REFERENCE - REF# to CATALOG#

| Mfr. Part No. | Catalog No. | Mfr. Name | Pg. # | Mfr. Part No. | Catalog No. | Mfr. Name | Pg. # |
|---------------|-------------|-----------------|-------|---------------|---------------|------------|-------|
| D7AF-10346-CA | 20-202 | Ford | 49 | DRA3099 | 1-2481-01HI | Delco-Remy | 67 |
| D7AZ-10346-A | 20-202 | Ford | 49 | DRA3146 | 1-2479-01MI | Delco-Remy | 84 |
| D7AZ-10346-B | 20-202 | Ford | 49 | DRA3218 | 1-2315-01 | Delco-Remy | 68 |
| D7AZ-10346-C | 20-202 | Ford | 49 | DRA3227 | 1-2456-01ND | Delco-Remy | 99 |
| D7AZ-11002-A | 2-1675-FD | Ford | 61 | DRA3286 | 1-2754-02LU | Delco-Remy | 77 |
| D7AZ-11002-B | 2-1675-FD | Ford | 61 | DRA3293 | 1-2754-02LU | Delco-Remy | 77 |
| D7HT-10300-AA | 20-133-1 | Ford | 18 | DRA3294 | 1-2762-01LU | Delco-Remy | 77 |
| D7HT-10300-BA | 20-131-1 | Ford | 18 | DRA3297 | 1-2482-01HI | Delco-Remy | 67 |
| D7HT-10300-CA | 20-501-1 | Ford | 73 | DRA3449 | 1-1946-01ND | Delco-Remy | 97 |
| D7HT-10300-DA | 20-501-1 | Ford | 73 | DRA3519 | 1-2132-01ND | Delco-Remy | 98 |
| D7HT-10300-EA | 20-501-1 | Ford | 73 | DRA3519 | 1-2132-01ND-2 | Delco-Remy | 98 |
| D7HZ-10346-A | 20-119-1 | Ford | 16 | DRA3548 | 1-2619-01LU | Delco-Remy | 76 |
| D7HZ-10346-D | 20-119-1 | Ford | 16 | DRA3553 | 1-2721-01LU | Delco-Remy | 77 |
| D7R14 | 2-2294-VA | Valeo | 112 | DRA3656 | 1-2454-01MM | Delco-Remy | 76 |
| D7R43 | 2-2355-BO | Valeo | 8 | DRA3667 | 1-2762-01LU | Delco-Remy | 77 |
| D7R43 | 2-2355-BO-1 | Valeo | 8 | DRA3668 | 1-2730-00LU | Delco-Remy | 77 |
| D7R46 | 2-2355-BO | Valeo | 8 | DRA3813 | 1-2313-01HI | Delco-Remy | 66 |
| D7R46 | 2-2355-BO-1 | Valeo | 8 | DRA3830 | 1-2754-02LU | Delco-Remy | 77 |
| D7TF-10300-AA | 20-202 | Ford | 49 | DRA3836 | 1-2454-01MM | Delco-Remy | 76 |
| D7TF-10300-BA | 20-202 | Ford | 49 | DRA3836 | 1-2455-01MM | Delco-Remy | 73 |
| D7TF-10300-CA | 20-202 | Ford | 49 | DRA3860 | 1-2754-02LU | Delco-Remy | 77 |
| D8AF-11001-AA | 2-1675-FD | Ford | 61 | DRA3888 | 1-2062-01MI | Delco-Remy | 84 |
| D8AF-11001-BA | 2-1675-FD | Ford | 61 | DRA4311 | 1-2312-01HI | Delco-Remy | 65 |
| D8BF-10300-AA | 20-202 | Ford | 49 | DRA4400 | 1-2711-00BO | Delco-Remy | 2 |
| D8BF-10300-BA | 20-202 | Ford | 49 | DRA5411 | 1-1112-01 | Delco-Remy | 65 |
| D8BF-10300-CA | 20-202 | Ford | 49 | DRA5411 | 1-2314-01HI | Delco-Remy | 66 |
| D8BF-10346-AA | 20-202 | Ford | 49 | DRA5411 | 1-2332-01HI | Delco-Remy | 66 |
| D8BF-10346-BA | 20-202 | Ford | 49 | DRA6240 | 1-2614-01VA | Delco-Remy | 112 |
| D8HZ-10346-A | 20-501-1 | Ford | 73 | DRA6641 | 1-2119-11ND | Delco-Remy | 98 |
| D8HZ-10346-B | 20-501-1 | Ford | 73 | DRA6641 | 1-2119-11ND-9 | Delco-Remy | 98 |
| D8HZ-10346-C | 20-501-1 | Ford | 73 | DRA6800 | 1-2435-01BO | Delco-Remy | 73 |
| D8HZ-10346-D | 20-133-1 | Ford | 18 | DRA7271 | 1-2436-01ND | Delco-Remy | 98 |
| D8HZ-10346-E | 20-131-1 | Ford | 18 | DRA7271 | 1-2476-01ND | Delco-Remy | 99 |
| D8HZ-10346-F | 20-131-1 | Ford | 18 | DRA7410 | 1-2711-00BO | Delco-Remy | 2 |
| D8HZ-11002-C | 50-111 | Ford | 43 | DRA7770 | 1-2711-00BO | Delco-Remy | 2 |
| D8HZ-11002-C | 50-111-1 | Ford | 43 | DRA7770 | 1-2711-01BO | Delco-Remy | 2 |
| D8VF-10300-BA | 1-1806-12FD | Ford | 49 | DRA9790 | 1-2711-00BO | Delco-Remy | 2 |
| D8VF-10346-AA | 20-202 | Ford | 49 | DRB0201 | 1-2741-01VA | Delco-Remy | 112 |
| D8ZE-10300-CA | 20-202 | Ford | 49 | DRB0260 | 1-2711-00BO | Delco-Remy | 2 |
| D8ZF-10300-AA | 20-202 | Ford | 49 | DRB0280 | 1-2344-00BO | Delco-Remy | 2 |
| D8ZF-10300-BA | 20-202 | Ford | 49 | DRB0290 | 1-2237-00BO | Delco-Remy | 2 |
| D8ZF-10300-CA | 20-202 | Ford | 49 | DRB1530 | 1-2768-01BO | Delco-Remy | 3 |
| D8ZF-10300-EA | 20-202 | Ford | 49 | DRS0970 | 2-2680-BO | Delco-Remy | 5 |
| D8ZF-10300-HA | 20-202 | Ford | 49 | DRS1040 | 50-9107 | Delco-Remy | 6 |
| D8ZF-10346-AA | 20-202 | Ford | 49 | DRS1310 | 2-2283-BO | Delco-Remy | 4 |
| D94F-10300-AA | 20-202 | Ford | 49 | DRS1340 | 2-2284-BO | Delco-Remy | 4 |
| D9AF-10300-BA | 20-202 | Ford | 49 | DRS1460 | 50-9115 | Delco-Remy | 7 |
| D9BF-10300-AA | 1-1806-12FD | Ford | 49 | DRS1510 | 50-9117 | Delco-Remy | 7 |
| D9BZ-10346-A | 20-202 | Ford | 49 | DRS1570 | 50-9117 | Delco-Remy | 7 |
| D9BZ-10346-B | 20-202 | Ford | 49 | DRS2061 | 2-1682-ND | Delco-Remy | 100 |
| D9HT-10300-DA | 20-202 | Ford | 49 | DRS2831 | 2-1728-MI | Delco-Remy | 85 |
| D9HT-10300-EA | 20-202 | Ford | 49 | DRS2831 | 2-1728-MI-3 | Delco-Remy | 92 |
| D9NN-11000-AA | 2-2026-HI | Ford | 69 | DRS2931 | 2-1741-1 | Delco-Remy | 86 |
| D9UF-10300-AA | 20-202 | Ford | 49 | DRS2932 | 2-1740-MI | Delco-Remy | 86 |
| D9UF-10300-BA | 20-202 | Ford | 49 | DRS3018 | 2-2238-ND | Delco-Remy | 107 |
| D9UF-10300-CA | 20-202 | Ford | 49 | DRS3059 | 2-2276-ND | Delco-Remy | 101 |
| D9UF-10300-DA | 20-202 | Ford | 49 | DRS3063 | 2-2277-ND | Delco-Remy | 101 |
| D9VF-10300-AA | 20-202 | Ford | 49 | DRS3064 | 2-2279-ND | Delco-Remy | 101 |
| D9VF-10346-AA | 20-202 | Ford | 49 | DRS3088 | 2-2229-MI | Delco-Remy | 91 |
| D9VY-10346-A | 20-202 | Ford | 49 | DRS3089 | 2-2228-MI | Delco-Remy | 91 |
| D9VY-10346-AA | 20-202 | Ford | 49 | DRS3115 | 2-2638 | Delco-Remy | 93 |
| D9VY-10346-B | 20-202 | Ford | 49 | DRS3128 | 2-2317-HI | Delco-Remy | 69 |
| D9ZF-10300-AA | 20-202 | Ford | 49 | DRS3144 | 2-1193-ND | Delco-Remy | 101 |
| D9ZF-10346-AA | 20-202 | Ford | 49 | DRS3166 | 2-2014-HI | Delco-Remy | 70 |
| D9ZZ-10346-A | 20-202 | Ford | 49 | DRS3184 | 2-2104-ND | Delco-Remy | 105 |
| DM2130 | 50-9900 | Electroprecizia | 49 | DRS3197 | 50-9200 | Delco-Remy | 82 |
| DM2134 | 50-9900 | Electroprecizia | 49 | DRS3197 | 50-9200-1 | Delco-Remy | 82 |
| DO3F-10300-DA | 20-202 | Ford | 49 | DRS3197 | 50-9200-2 | Delco-Remy | 82 |
| DRA0072 | 3-1005-01LU | Delco-Remy | 77 | DRS3208 | 2-2106-ND | Delco-Remy | 105 |
| DRA0780 | 1-2754-02LU | Delco-Remy | 77 | DRS3217 | 2-2105-ND | Delco-Remy | 105 |
| DRA0790 | 1-2762-01LU | Delco-Remy | 77 | DRS3219 | 2-2230-HI | Delco-Remy | 71 |
| DRA1680 | 1-2619-01LU | Delco-Remy | 76 | DRS3228 | 2-1960-ND-2 | Delco-Remy | 104 |

CROSS REFERENCE

CROSS REFERENCE - REF# to CATALOG#

| Mfr. Part# | Catalog# | Mfr. Name | Pg. # | Mfr. Part# | Catalog# | Mfr. Name | Pg. # |
|------------|---------------|------------|-------|---------------|---------------|------------|-------|
| DRS3235 | 2-1612-MI | Delco-Remy | 88 | DRZ0151 | 20-145-11-1 | Delco-Remy | 23 |
| DRS3235 | 2-1612-MI-2 | Delco-Remy | 88 | DRZ0151 | 20-145-21-1 | Delco-Remy | 23 |
| DRS3236 | 2-1732-MI-1 | Delco-Remy | 88 | DRZ0162 | 20-152-11-1 | Delco-Remy | 23 |
| DRS3246 | 2-1734-HI | Delco-Remy | 70 | DRZ0165 | 20-145-31-1 | Delco-Remy | 23 |
| DRS3247 | 2-2705-ND-2 | Delco-Remy | 109 | DRZ0166 | 20-142-32-1 | Delco-Remy | 22 |
| DRS3257 | 2-1754-ND | Delco-Remy | 103 | DRZ0170 | 1-1504-01ND-2 | Delco-Remy | 95 |
| DRS3263 | 2-1913-MI-1 | Delco-Remy | 89 | DRZ0170 | 1-1504-06ND-2 | Delco-Remy | 96 |
| DRS3278 | 2-2101-MI | Delco-Remy | 90 | DRZ0182 | 20-110-2 | Delco-Remy | 10 |
| DRS3279 | 2-2102-MI | Delco-Remy | 90 | DRZ0185 | 1-1503-01ND-2 | Delco-Remy | 95 |
| DRS3283 | 2-1963-MI | Delco-Remy | 89 | DRZ5160 | 2-1894-FD-1 | Delco-Remy | 63 |
| DRS3284 | 2-2103-MI | Delco-Remy | 90 | E0HT-10300-AA | 20-133-1 | Ford | 18 |
| DRS3286 | 2-2302-LU | Delco-Remy | 79 | E0SF-10300-AA | 20-202 | Ford | 49 |
| DRS3286 | 2-2302-LU-1 | Delco-Remy | 79 | E0TF-10300-AA | 20-202 | Ford | 49 |
| DRS3287 | 2-2340-LU | Delco-Remy | 81 | E1AF-10300-CA | 20-202 | Ford | 49 |
| DRS3287 | 2-2340-LU-1 | Delco-Remy | 81 | E1BF-10300-AA | 20-202 | Ford | 49 |
| DRS3289 | 2-2458-LU | Delco-Remy | 81 | E1BF-10300-CA | 1-1806-12FD | Ford | 49 |
| DRS3289 | 2-2458-LU-1 | Delco-Remy | 81 | E1BF-10300-HA | 20-202 | Ford | 49 |
| DRS3327 | 2-1855-HI | Delco-Remy | 69 | E1BF-10346-AA | 20-202 | Ford | 49 |
| DRS3333 | 2-2305-LU | Delco-Remy | 79 | E1BF-10346-BA | 20-202 | Ford | 49 |
| DRS3336 | 2-2301-LU | Delco-Remy | 78 | E1BZ-10346-B | 20-202 | Ford | 49 |
| DRS3337 | 2-2282-LU | Delco-Remy | 80 | E1EF-10300-EB | 20-202 | Ford | 49 |
| DRS3345 | 2-1444-MI | Delco-Remy | 92 | E1EF-10300-FB | 20-202 | Ford | 49 |
| DRS3345 | 2-1444-MI-9 | Delco-Remy | 92 | E1EF-10300-HA | 20-202 | Ford | 49 |
| DRS3363 | 2-1733-MI | Delco-Remy | 88 | E1EF-10300-JA | 20-202 | Ford | 49 |
| DRS3364 | 2-2037-HI | Delco-Remy | 70 | E1EF-10300-LA | 20-202 | Ford | 49 |
| DRS3365 | 2-1736-HI-1 | Delco-Remy | 68 | E1EF-10300-MA | 20-202 | Ford | 49 |
| DRS3376 | 2-1776-HI | Delco-Remy | 70 | E1GF-10300-DA | 20-202 | Ford | 49 |
| DRS3396 | 50-9202 | Delco-Remy | 79 | E1GF-10346-EA | 20-202 | Ford | 49 |
| DRS3405 | 50-9900 | Delco-Remy | 49 | E1HT-10300-AA | 20-202 | Ford | 49 |
| DRS3409 | 2-2687-LU | Delco-Remy | 81 | E1HT-10300-BA | 20-202 | Ford | 49 |
| DRS3423 | 2-2296-LU | Delco-Remy | 78 | E1TF-10300-AA | 20-202 | Ford | 49 |
| DRS3425 | 2-2295-LU | Delco-Remy | 78 | E1VF-10300-AA | 1-1806-12FD | Ford | 49 |
| DRS3425 | 2-2295-LU-1 | Delco-Remy | 78 | E1ZF-10300-AA | 20-202 | Ford | 49 |
| DRS3427 | 2-2292-LU | Delco-Remy | 80 | E1ZF-10300-BA | 20-202 | Ford | 49 |
| DRS3456 | 2-2304-LU | Delco-Remy | 81 | E1ZF-10300-CA | 20-202 | Ford | 49 |
| DRS3456 | 2-2304-LU-1 | Delco-Remy | 81 | E1ZF-10300-DA | 20-202 | Ford | 49 |
| DRS3490 | 2-2297-BO | Delco-Remy | 4 | E1ZF-10300-FA | 20-202 | Ford | 49 |
| DRS3537 | 2-1960-ND | Delco-Remy | 104 | E1ZF-10346-AA | 20-202 | Ford | 49 |
| DRS3539 | 2-1726-ND-2 | Delco-Remy | 102 | E1ZZ-10346-A | 20-202 | Ford | 49 |
| DRS3578 | 2-2311-HI | Delco-Remy | 72 | E25F-11001-AA | 2-1648-FD | Ford | 60 |
| DRS3598 | 2-1781-MI | Delco-Remy | 88 | E25Y-11002-A | 2-1648-FD | Ford | 60 |
| DRS3703 | 2-2007-HI | Delco-Remy | 69 | E25Z-11002-A | 2-1648-FD | Ford | 60 |
| DRS3703 | 2-2690-BO | Delco-Remy | 9 | E27F-10300-AA | 20-202 | Ford | 49 |
| DRS3709 | 2-2089-MI | Delco-Remy | 86 | E27F-10300-BA | 20-202 | Ford | 49 |
| DRS3770 | 2-2299-BO | Delco-Remy | 5 | E2BF-10300-AA | 20-202 | Ford | 49 |
| DRS3796 | 2-2300-LU | Delco-Remy | 78 | E2GZ-10346-C | 20-202 | Ford | 49 |
| DRS3796 | 2-2300-LU-1 | Delco-Remy | 78 | E2HF-10346-AA | 20-210-1 | Ford | 50 |
| DRS3845 | 2-2012-HI | Delco-Remy | 70 | E2HF-10346-BA | 20-210-1 | Ford | 50 |
| DRS3883 | 2-2321-HI | Delco-Remy | 72 | E2HF-10346-CA | 20-210-1 | Ford | 50 |
| DRS3938 | 2-2553-BO | Delco-Remy | 8 | E2HF-10346-DA | 20-210-1 | Ford | 50 |
| DRS3944 | 2-2235-HI | Delco-Remy | 71 | E2HT-10300-DB | 20-210-1 | Ford | 50 |
| DRS4251 | 2-1727-MI | Delco-Remy | 85 | E2HT-10300-EB | 20-210-1 | Ford | 50 |
| DRS5040 | 2-2303-LU | Delco-Remy | 80 | E2HT-10300-FA | 20-210-1 | Ford | 50 |
| DRS6390 | 2-2355-BO | Delco-Remy | 8 | E2HT-10300-GA | 20-210-1 | Ford | 50 |
| DRS6390 | 2-2355-BO-1 | Delco-Remy | 8 | E2HT-11001-DA | 50-111 | Ford | 43 |
| DRS6520 | 50-9117 | Delco-Remy | 7 | E2HT-11001-DA | 50-111-1 | Ford | 43 |
| DRS6930 | 2-2355-BO-1 | Delco-Remy | 8 | E2HZ-10346-B | 20-210-1 | Ford | 50 |
| DRS7240 | 2-2770-NK | Delco-Remy | 94 | E2HZ-10346-C | 20-210-1 | Ford | 50 |
| DRS7260 | 2-2355-BO | Delco-Remy | 8 | E2HZ-10346-D | 20-210-1 | Ford | 50 |
| DRS7260 | 2-2355-BO-1 | Delco-Remy | 8 | E2HZ-10346-E | 20-210-1 | Ford | 50 |
| DRS7430 | 2-1946-BO | Delco-Remy | 7 | E36646 | 2-2296-LU | Case | 78 |
| DRS7490 | 2-2463-BO | Delco-Remy | 8 | E37F-10300-BA | 20-202 | Ford | 49 |
| DRS8070 | 2-2362-BO | Delco-Remy | 8 | E37F-10300-CA | 20-202 | Ford | 49 |
| DRS8270 | 2-2355-BO | Delco-Remy | 8 | E37F-10300-DA | 20-202 | Ford | 49 |
| DRS8270 | 2-2355-BO-1 | Delco-Remy | 8 | E3AF-11001-AA | 2-1648-FD | Ford | 60 |
| DRZ0102 | 20-101-1 | Delco-Remy | 9 | E3AZ-11002-A | 2-1648-FD | Ford | 60 |
| DRZ0115 | 20-127-1 | Delco-Remy | 18 | E3EF-10300-BA | 20-202 | Ford | 49 |
| DRZ0129 | 20-104-1 | Delco-Remy | 10 | E3EF-10346-BA | 20-202 | Ford | 49 |
| DRZ0131 | 20-102-1 | Delco-Remy | 10 | E3HZ-11002-A | 50-111 | Ford | 43 |
| DRZ0136 | 1-1503-05ND-2 | Delco-Remy | 95 | E3HZ-11002-A | 50-111-1 | Ford | 43 |
| DRZ0136 | 1-1503-06ND-2 | Delco-Remy | 95 | E3HZ-11002-B | 50-111 | Ford | 43 |
| DRZ0136 | 1-1527-02ND-2 | Delco-Remy | 96 | E3HZ-11002-B | 50-111-1 | Ford | 43 |

CROSS REFERENCE

CROSS REFERENCE - REF# to CATALOG#

| Mfr. Part No. | Catalog No. | Mfr. Name | Pg. # | Mfr. Part No. | Catalog No. | Mfr. Name | Pg. # |
|---------------|-------------|-----------|-------|---------------|-------------|-----------|-------|
| E3HZ-11002-C | 50-111 | Ford | 43 | E5TZ-11002-B | 2-1254-MI-2 | Ford | 87 |
| E3HZ-11002-C | 50-111-1 | Ford | 43 | E62F-10300-CA | 20-208-30-1 | Ford | 51 |
| E3TF-10300-BA | 20-202 | Ford | 49 | E62F-10300-CA | 20-216-30 | Ford | 50 |
| E3TF-11000-AA | 50-157-9 | Ford | 28 | E63F-10300-AB | 20-207-30-1 | Ford | 51 |
| E3TF-11001-AA | 2-1642-FD | Ford | 60 | E63F-10300-AB | 20-220-30 | Ford | 51 |
| E3TZ-11002-A | 2-1642-FD | Ford | 60 | E63F-10300-BB | 20-207-30-1 | Ford | 51 |
| E3TZ-11002-B | 50-157-9 | Ford | 28 | E63F-10300-BB | 20-220-30 | Ford | 51 |
| E3TZ-11002-E | 2-1649-FD | Ford | 60 | E63F-10300-CB | 20-207-30-1 | Ford | 51 |
| E3ZF-10300-BA | 20-202 | Ford | 49 | E63F-10300-CB | 20-220-30 | Ford | 51 |
| E3ZF-10300-EA | 20-202 | Ford | 49 | E63F-10300-DA | 20-207-30-1 | Ford | 51 |
| E43F-10300-EA | 20-207-30-1 | Ford | 51 | E63F-10300-DA | 20-220-30 | Ford | 51 |
| E43F-10300-EA | 20-220-30 | Ford | 51 | E63F-10346-BA | 20-207-30-1 | Ford | 51 |
| E43F-10300-PA | 20-207-30-1 | Ford | 51 | E63F-10346-BA | 20-220-30 | Ford | 51 |
| E43F-10300-PA | 20-220-30 | Ford | 51 | E63Z-10346-A | 20-207-30-1 | Ford | 51 |
| E43F-10300-RA | 20-207-30-1 | Ford | 51 | E63Z-10346-A | 20-220-30 | Ford | 51 |
| E43F-10300-RA | 20-220-30 | Ford | 51 | E63Z-10346-B | 20-207-30-1 | Ford | 51 |
| E43F-10346-BA | 20-207-30-1 | Ford | 51 | E63Z-10346-B | 20-220-30 | Ford | 51 |
| E43F-10346-BA | 20-220-30 | Ford | 51 | E67F-10300-CA | 20-216-10 | Ford | 50 |
| E43Z-10346-B | 20-207-30-1 | Ford | 51 | E67F-10300-DA | 20-216-10 | Ford | 50 |
| E43Z-10346-B | 20-220-30 | Ford | 51 | E67F-10300-EA | 20-207-30-1 | Ford | 51 |
| E43Z-10346-D | 20-207-30-1 | Ford | 51 | E67F-10300-EA | 20-220-30 | Ford | 51 |
| E43Z-10346-D | 20-220-30 | Ford | 51 | E67F-10300-FA | 20-207-30-1 | Ford | 51 |
| E47F-10300-AA | 20-202 | Ford | 49 | E67F-10300-FA | 20-220-30 | Ford | 51 |
| E47F-10300-BA | 20-202 | Ford | 49 | E67F-10346-AA | 20-216-10 | Ford | 50 |
| E47F-10300-CA | 20-202 | Ford | 49 | E67F-10346-CA | 20-216-10 | Ford | 50 |
| E47F-11001-AA | 2-1649-FD | Ford | 60 | E69F-10300-AA | 20-207-30-1 | Ford | 51 |
| E4AF-11001-AA | 2-1648-FD | Ford | 60 | E69F-10300-AA | 20-220-30 | Ford | 51 |
| E4DF-11001-BA | 2-1648-FD | Ford | 60 | E69F-10300-BA | 20-207-30-1 | Ford | 51 |
| E4DZ-11002-B | 2-1648-FD | Ford | 60 | E69F-10300-BA | 20-220-30 | Ford | 51 |
| E4HT-10300-AA | 20-210-1 | Ford | 50 | E69F-10346-AA | 20-207-30-1 | Ford | 51 |
| E4HT-10300-BA | 20-131-1 | Ford | 18 | E69F-10346-AA | 20-220-30 | Ford | 51 |
| E4HT-10300-CA | 20-133-1 | Ford | 18 | E69F-10346-BA | 20-207-30-1 | Ford | 51 |
| E4HZ-11002-A | 2-2473-DR | Ford | 43 | E69F-10346-BA | 20-220-30 | Ford | 51 |
| E4HZ-11002-B | 2-2473-DR | Ford | 43 | E69Z-10346-A | 20-207-30-1 | Ford | 51 |
| E4TF-10300-AA | 20-202 | Ford | 49 | E69Z-10346-A | 20-220-30 | Ford | 51 |
| E4TF-10300-BA | 20-202 | Ford | 49 | E6AF-10300-AA | 20-208-30-1 | Ford | 51 |
| E4TF-10300-CA | 20-202 | Ford | 49 | E6AF-10300-AA | 20-216-30 | Ford | 50 |
| E4TF-11000-AA | 50-157-9 | Ford | 28 | E6AF-10300-BA | 20-208-30-1 | Ford | 51 |
| E4TF-11001-AA | 2-1642-FD | Ford | 60 | E6AF-10300-BA | 20-216-30 | Ford | 50 |
| E4TZ-11002-A | 2-1642-FD | Ford | 60 | E6DF-10300-BA | 20-207-30-1 | Ford | 51 |
| E4UF-10300-AA | 20-202 | Ford | 49 | E6DF-10300-BA | 20-207-31-2 | Ford | 50 |
| E4ZF-10300-BA | 20-202 | Ford | 49 | E6DF-10300-BA | 20-220-30 | Ford | 51 |
| E4ZF-10300-CA | 20-202 | Ford | 49 | E6DF-10300-DA | 20-207-30-1 | Ford | 51 |
| E53F-10300-AA | 20-207-30-1 | Ford | 51 | E6DF-10300-DA | 20-220-30 | Ford | 51 |
| E53F-10300-AA | 20-220-30 | Ford | 51 | E6DF-10300-EA | 20-207-30-1 | Ford | 51 |
| E53F-10300-BA | 20-207-30-1 | Ford | 51 | E6DF-10300-EA | 20-207-31-2 | Ford | 50 |
| E53F-10300-BA | 20-220-30 | Ford | 51 | E6DF-10300-EA | 20-220-30 | Ford | 51 |
| E53F-10300-DA | 20-207-30-1 | Ford | 51 | E6DF-10300-EB | 20-207-30-1 | Ford | 51 |
| E53F-10300-DA | 20-220-30 | Ford | 51 | E6DF-10300-EB | 20-207-31-2 | Ford | 50 |
| E53F-10300-EA | 20-207-30-1 | Ford | 51 | E6DF-10300-EB | 20-220-30 | Ford | 51 |
| E53F-10300-EA | 20-220-30 | Ford | 51 | E6DF-10300-GA | 20-207-30-1 | Ford | 51 |
| E53F-10300-FA | 20-207-30-1 | Ford | 51 | E6DF-10300-GA | 20-220-30 | Ford | 51 |
| E53F-10300-FA | 20-220-30 | Ford | 51 | E6DF-10346-BA | 20-207-30-1 | Ford | 51 |
| E53F-10300-GA | 20-207-30-1 | Ford | 51 | E6DF-10346-BA | 20-220-30 | Ford | 51 |
| E53F-10300-GA | 20-220-30 | Ford | 51 | E6DF-10346-CA | 20-207-30-1 | Ford | 51 |
| E53F-10300-HA | 20-207-30-1 | Ford | 51 | E6DF-10346-CA | 20-207-31-2 | Ford | 50 |
| E53F-10300-HA | 20-220-30 | Ford | 51 | E6DF-10346-CA | 20-220-30 | Ford | 51 |
| E53F-10346-BA | 20-207-30-1 | Ford | 51 | E6DZ-10346-B | 20-207-30-1 | Ford | 51 |
| E53F-10346-BA | 20-220-30 | Ford | 51 | E6DZ-10346-B | 20-220-30 | Ford | 51 |
| E53F-10346-DA | 20-207-30-1 | Ford | 51 | E6DZ-10346-C | 20-207-30-1 | Ford | 51 |
| E53F-10346-DA | 20-220-30 | Ford | 51 | E6DZ-10346-C | 20-207-31-2 | Ford | 50 |
| E53Z-10346-A | 20-207-30-1 | Ford | 51 | E6DZ-10346-C | 20-220-30 | Ford | 51 |
| E53Z-10346-A | 20-220-30 | Ford | 51 | E6EF-10300-EA | 20-207-30-1 | Ford | 51 |
| E57F-10300-AA | 20-216-10 | Ford | 50 | E6EF-10300-EA | 20-220-30 | Ford | 51 |
| E57F-10300-BA | 20-216-10 | Ford | 50 | E6EF-10300-FA | 20-207-30-1 | Ford | 51 |
| E57F-10346-BA | 20-216-10 | Ford | 50 | E6EF-10300-FA | 20-220-30 | Ford | 51 |
| E59F-10300-DA | 20-207-30-1 | Ford | 51 | E6EF-10300-GA | 20-207-30-1 | Ford | 51 |
| E59F-10300-DA | 20-220-30 | Ford | 51 | E6EF-10300-GA | 20-220-30 | Ford | 51 |
| E5HS-10300-BA | 20-131-1 | Ford | 18 | E6EF-10300-HA | 20-207-30-1 | Ford | 51 |
| E5HT-11001-AA | 50-193-1 | Ford | 36 | E6EF-10300-HA | 20-220-30 | Ford | 51 |
| E5TF-11000-AA | 2-1254-MI-2 | Ford | 87 | E6EF-10300-JA | 20-207-30-1 | Ford | 51 |
| E5TZ-10346-A | 20-216-10 | Ford | 50 | E6EF-10300-JA | 20-220-30 | Ford | 51 |

CROSS REFERENCE

CROSS REFERENCE - REF# to CATALOG#

| Mfr. Part# | Catalog# | Mfr. Name | Pg. # | Mfr. Part# | Catalog# | Mfr. Name | Pg. # |
|----------------|----------------|-----------|---------|---------------|----------------|-----------|---------|
| E6EF-10346-AA | ...20-220-10 |Ford |51 | E7PF-10346-BA | ...20-207-30-1 |Ford |51 |
| E6EF-10346-CA | ...20-207-30-1 |Ford |51 | E7PF-10346-BA | ...20-220-30 |Ford |51 |
| E6EF-10346-CA | ...20-220-30 |Ford |51 | E7PF-10346-CA | ...20-216-10 |Ford |50 |
| E6FZ-10346-A | ...20-207-30-1 |Ford |51 | E7PF-10346-DA | ...20-216-10 |Ford |50 |
| E6FZ-10346-A | ...20-220-30 |Ford |51 | E7PF-10346-FA | ...20-207-30-1 |Ford |51 |
| E6FZ-10346-C | ...20-207-30-1 |Ford |51 | E7PF-10346-FA | ...20-220-30 |Ford |51 |
| E6FZ-10346-C | ...20-220-30 |Ford |51 | E7PF-10346-GA | ...20-208-30-1 |Ford |51 |
| E6HT-11001-AA | ...50-100-1 |Ford |40 | E7PF-10346-GA | ...20-216-30 |Ford |50 |
| E6HT-11001-AA | ...50-100-2 |Ford |40 | E7PF-10346-KA | ...20-207-30-1 |Ford |51 |
| E6HT-11001-CA | ...50-153-1 |Ford |43 | E7PF-10346-KA | ...20-220-30 |Ford |51 |
| E6HT-11001-CA | ...50-153-2 |Ford |43 | E7PF-10346-LA | ...20-208-30-1 |Ford |51 |
| E6HZ-11002-A | ...50-193-1 |Ford |36 | E7PF-10346-LA | ...20-216-30 |Ford |50 |
| E6HZ-11002-B | ...50-100-1 |Ford |40 | E7PF-10346-MA | ...20-208-30-1 |Ford |51 |
| E6HZ-11002-B | ...50-100-2 |Ford |40 | E7PF-10346-MA | ...20-216-30 |Ford |50 |
| E6HZ-11002-C | ...50-153-1 |Ford |43 | E7PF-10346-NA | ...20-207-30-1 |Ford |51 |
| E6HZ-11002-C | ...50-153-2 |Ford |43 | E7PF-10346-NA | ...20-207-31-2 |Ford |50 |
| E6HZ-11002-D | ...50-153-1 |Ford |43 | E7PF-10346-NA | ...20-220-30 |Ford |51 |
| E6HZ-11002-D | ...50-153-2 |Ford |43 | E7PF-10346-UA | ...20-208-30-1 |Ford |51 |
| E6SF-10300-BA | ...20-208-30-1 |Ford |51 | E7PF-10346-UA | ...20-216-30 |Ford |50 |
| E6SF-10300-BA | ...20-216-30 |Ford |50 | E7PF-10346-XA | ...20-220-10 |Ford |51 |
| E6SF-10300-DA | ...20-202 |Ford |49 | E7PF-10346-ZA | ...20-208-30-1 |Ford |51 |
| E6SF-10300-EA | ...20-202 |Ford |49 | E7PF-10346-ZA | ...20-216-30 |Ford |50 |
| E6TF-10300-BA | ...20-208-30-1 |Ford |51 | E7PZ-10346-C | ...20-208-30-1 |Ford |51 |
| E6TF-10300-BA | ...20-216-30 |Ford |50 | E7PZ-10346-C | ...20-216-30 |Ford |50 |
| E6TF-10300-CA | ...20-208-30-1 |Ford |51 | E7PZ-10346-D | ...20-207-30-1 |Ford |51 |
| E6TF-10300-CA | ...20-216-30 |Ford |50 | E7PZ-10346-D | ...20-207-31-2 |Ford |50 |
| E6TF-10300-DA | ...20-208-30-1 |Ford |51 | E7PZ-10346-D | ...20-220-30 |Ford |51 |
| E6TF-10300-DA | ...20-216-30 |Ford |50 | E7PZ-10346-E | ...20-208-30-1 |Ford |51 |
| E6TF-10346-AA | ...20-208-30-1 |Ford |51 | E7PZ-10346-E | ...20-216-30 |Ford |50 |
| E6TF-10346-AA | ...20-216-30 |Ford |50 | E7PZ-10346-F | ...20-207-30-1 |Ford |51 |
| E6TZ-10346-A | ...20-208-30-1 |Ford |51 | E7PZ-10346-F | ...20-220-30 |Ford |51 |
| E6TZ-10346-A | ...20-216-30 |Ford |50 | E7PZ-10346-G | ...20-207-30-1 |Ford |51 |
| E6TZ-10346-B | ...20-216-10 |Ford |50 | E7PZ-10346-G | ...20-220-30 |Ford |51 |
| E6TZ-10346-C | ...20-216-10 |Ford |50 | E7PZ-10346-H | ...20-216-10 |Ford |50 |
| E6UF-10300-AA | ...20-208-30-1 |Ford |51 | E7PZ-10346-J | ...20-207-30-1 |Ford |51 |
| E6UF-10300-AA | ...20-216-30 |Ford |50 | E7PZ-10346-J | ...20-220-30 |Ford |51 |
| E6ZF-10300-CA | ...20-208-30-1 |Ford |51 | E7PZ-10346-K | ...20-216-10 |Ford |50 |
| E6ZF-10300-CA | ...20-216-30 |Ford |50 | E7PZ-10346-L | ...20-208-30-1 |Ford |51 |
| E6ZF-10346-BA | ...20-208-30-1 |Ford |51 | E7PZ-10346-L | ...20-216-30 |Ford |50 |
| E6ZF-10346-BA | ...20-216-30 |Ford |50 | E7PZ-10346-M | ...20-208-30-1 |Ford |51 |
| E6ZZ-10346-B | ...20-208-30-1 |Ford |51 | E7PZ-10346-M | ...20-216-30 |Ford |50 |
| E6ZZ-10346-B | ...20-216-30 |Ford |50 | E7PZ-10346-N | ...20-220-10 |Ford |51 |
| E72F-10300-DA | ...20-208-30-1 |Ford |51 | E7SF-10300-FA | ...20-208-30-1 |Ford |51 |
| E72F-10300-DA | ...20-216-30 |Ford |50 | E7SF-10300-FA | ...20-216-30 |Ford |50 |
| E73F-10300-BA | ...20-207-30-1 |Ford |51 | E7SF-10300-GA | ...20-207-30-1 |Ford |51 |
| E73F-10300-BA | ...20-220-30 |Ford |51 | E7SF-10300-GA | ...20-220-30 |Ford |51 |
| E73F-10300-CA | ...20-207-30-1 |Ford |51 | E7SF-10300-HA | ...20-208-30-1 |Ford |51 |
| E73F-10300-CA | ...20-220-30 |Ford |51 | E7SF-10300-HA | ...20-216-30 |Ford |50 |
| E79F-10300-BA | ...20-216-10 |Ford |50 | E7SF-10300-KA | ...20-208-30-1 |Ford |51 |
| E7AF-10300-BA | ...20-208-30-1 |Ford |51 | E7SF-10300-KA | ...20-216-30 |Ford |50 |
| E7AF-10300-BA | ...20-216-30 |Ford |50 | E7SF-10300-LA | ...20-207-30-1 |Ford |51 |
| E7AF-10300-CA | ...20-208-30-1 |Ford |51 | E7SF-10300-LA | ...20-220-30 |Ford |51 |
| E7AF-10300-CA | ...20-216-30 |Ford |50 | E7SF-10300-MA | ...20-208-30-1 |Ford |51 |
| E7AF-10300-DA | ...20-208-30-1 |Ford |51 | E7SF-10300-MA | ...20-216-30 |Ford |50 |
| E7AF-10300-DA | ...20-216-30 |Ford |50 | E7TF-10300-BA | ...20-216-10 |Ford |50 |
| E7DF-10300-GA | ...20-207-30-1 |Ford |51 | E7TF-10300-LA | ...20-216-10 |Ford |50 |
| E7DF-10300-GA | ...20-220-30 |Ford |51 | E7TF-10300-MA | ...20-207-30-1 |Ford |51 |
| E7EF-10300-CB | ...20-207-30-1 |Ford |51 | E7TF-10300-MA | ...20-220-30 |Ford |51 |
| E7EF-10300-CB | ...20-220-30 |Ford |51 | E7TF-10300-SA | ...20-220-10 |Ford |51 |
| E7EF-10300-DB | ...20-207-30-1 |Ford |51 | E7ZF-10300-BA | ...20-208-30-1 |Ford |51 |
| E7EF-10300-DB | ...20-220-30 |Ford |51 | E7ZF-10300-BA | ...20-216-30 |Ford |50 |
| E7EF-10300-EB | ...20-207-30-1 |Ford |51 | E7ZF-10300-DA | ...20-208-30-1 |Ford |51 |
| E7EF-10300-EB | ...20-220-30 |Ford |51 | E7ZF-10300-DA | ...20-216-30 |Ford |50 |
| E7EF-10300-FB | ...20-207-30-1 |Ford |51 | E7ZF-10300-EA | ...20-208-30-1 |Ford |51 |
| E7EF-10300-FB | ...20-220-30 |Ford |51 | E7ZF-10300-EA | ...20-216-30 |Ford |50 |
| E7EF-10300-GA | ...20-207-30-1 |Ford |51 | E7ZF-10300-FA | ...20-208-30-1 |Ford |51 |
| E7EF-10300-GA | ...20-220-30 |Ford |51 | E7ZF-10300-FA | ...20-216-30 |Ford |50 |
| E7HS-10346-AA | ...20-1163-1 |Ford |19 | E87F-10300-AA | ...20-207-30-1 |Ford |51 |
| E7HT-10300-CA | ...20-119-1 |Ford |16 | E87F-10300-AA | ...20-220-30 |Ford |51 |
| E7HZ-10346-A | ...20-119-1 |Ford |16 | E87F-10300-BA | ...20-207-30-1 |Ford |51 |
| E7PF-10346-AA | ...20-216-10 |Ford |50 | E87F-10300-BA | ...20-220-30 |Ford |51 |
| E7PF-10346-AAA | ...20-210-1 |Ford |50 | E87F-10300-CA | ...20-207-30-1 |Ford |51 |

CROSS REFERENCE - REF# to CATALOG#

| Mfr. Part No. | Catalog No. | Mfr. Name | Pg. # | Mfr. Part No. | Catalog No. | Mfr. Name | Pg. # |
|-----------------|-------------|-----------|-------|----------------|-------------|-----------|-------|
| E87F-10300-CA | 20-220-30 | Ford | 51 | F07U-10346-AC | 20-221-10-2 | Ford | 52 |
| E8EF-10300-AB | 20-207-30-1 | Ford | 51 | F07U-11000-AA | 50-220-1 | Ford | 64 |
| E8EF-10300-AB | 20-220-30 | Ford | 51 | F07U-11000-BA | 2-1885-FD-1 | Ford | 62 |
| E8HT-10300-HA | 20-216-10 | Ford | 50 | F09F-10300-AA | 20-219-10 | Ford | 51 |
| E8HT-10300-JA | 20-501-1 | Ford | 73 | F09F-10300-BA | 20-219-10 | Ford | 51 |
| E8HT-10300-KA | 20-501-1 | Ford | 73 | F0EU-10300-AA | 20-207-30-1 | Ford | 51 |
| E8HT-11001-AA | 2-2471-DR | Ford | 41 | F0EU-10300-AA | 20-220-30 | Ford | 51 |
| E8HZ-10346-A | 20-131-1 | Ford | 18 | F0HT-10300-AA | 20-1163-1 | Ford | 19 |
| E8HZ-10346-J | 20-501-1 | Ford | 73 | F0HT-10300-EA | 20-1163-1 | Ford | 19 |
| E8HZ-10346-K | 20-502-1 | Ford | 74 | F0HT-11001-AA | 50-153-1 | Ford | 43 |
| E8HZ-11002-A | 2-2471-DR | Ford | 41 | F0HT-11001-AA | 50-153-2 | Ford | 43 |
| E8HZ-11002-HA | 2-2471-DR | Ford | 41 | F0HT-11001-AB | 50-153-1 | Ford | 43 |
| E8PF-10346-AA | 20-208-30-1 | Ford | 51 | F0HT-11001-AB | 50-153-2 | Ford | 43 |
| E8PF-10346-AA | 20-216-30 | Ford | 50 | F0HU-10346-AA | 20-210-1 | Ford | 50 |
| E8PF-10346-CB | 20-207-30-1 | Ford | 51 | F0HU-10346-BA | 20-210-1 | Ford | 50 |
| E8PF-10346-CB | 20-220-30 | Ford | 51 | F0HU-10346-CA | 20-210-1 | Ford | 50 |
| E8PF-10346-DA | 20-220-10 | Ford | 51 | F0HU-10346-DA | 20-210-1 | Ford | 50 |
| E8PZ-10346-A | 20-208-30-1 | Ford | 51 | F0HU-10346-EA | 20-210-1 | Ford | 50 |
| E8PZ-10346-A | 20-216-30 | Ford | 50 | F0HU-10346-FA | 20-210-1 | Ford | 50 |
| E8PZ-10346-AA | 20-210-1 | Ford | 50 | F0HZ-10346-A | 20-210-1 | Ford | 50 |
| E8PZ-10346-C | 20-220-10 | Ford | 51 | F0HZ-10346-B | 20-210-1 | Ford | 50 |
| E8SF-10300-BA | 20-208-30-1 | Ford | 51 | F0HZ-10346-C | 20-210-1 | Ford | 50 |
| E8SF-10300-BA | 20-216-30 | Ford | 50 | F0HZ-10346-D | 20-210-1 | Ford | 50 |
| E8TF-10300-BA | 20-208-30-1 | Ford | 51 | F0HZ-10346-E | 20-210-1 | Ford | 50 |
| E8TF-10300-BA | 20-216-30 | Ford | 50 | F0HZ-10346-F | 20-210-1 | Ford | 50 |
| E8TF-10300-CA | 20-220-10 | Ford | 51 | F0HZ-10346-H | 20-1163-1 | Ford | 19 |
| E8TF-11000-AA | 2-1254-MI-2 | Ford | 87 | F0HZ-11002-A | 50-153-1 | Ford | 43 |
| E8TZ-11002-A | 2-1254-MI-2 | Ford | 87 | F0HZ-11002-A | 50-153-2 | Ford | 43 |
| E97F-10300-AB | 20-220-10 | Ford | 51 | F0PF-10346-AA | 20-219-10 | Ford | 51 |
| E97F-10300-BA | 20-216-10 | Ford | 50 | F0PF-10346-BA | 20-219-10 | Ford | 51 |
| E99F-10300-AB | 20-216-10 | Ford | 50 | F0PU-10346-BD | 20-221-10-2 | Ford | 52 |
| E99F-10300-BA | 20-216-10 | Ford | 50 | F0PU-10346-CA | 20-229-31-2 | Ford | 55 |
| E9EF-10300-AA | 20-207-30-1 | Ford | 51 | F0PU-10346-NC | 20-229-31-2 | Ford | 55 |
| E9EF-10300-AA | 20-220-30 | Ford | 51 | F0PZ-10346-A | 20-219-10 | Ford | 51 |
| E9EF-10300-BA | 20-207-30-1 | Ford | 51 | F0PZ-10346-B | 20-219-10 | Ford | 51 |
| E9EF-10300-BA | 20-220-30 | Ford | 51 | F0PZ-10346-E | 20-216-10 | Ford | 50 |
| E9HS-10300-BA | 20-1163-1 | Ford | 19 | F0PZ-10346-F | 20-220-10 | Ford | 51 |
| E9HT-10300-BA | 20-501-1 | Ford | 73 | F0TU-10300-CA | 20-220-10 | Ford | 51 |
| E9HT-11001-BA | 50-193-1 | Ford | 36 | F0TU-10300-DA | 20-220-10 | Ford | 51 |
| E9HZ-11002-A | 50-193-1 | Ford | 36 | F0TU-10300-EA | 20-216-10 | Ford | 50 |
| E9PF-10300-AB | 20-216-10 | Ford | 50 | F0TU-10300-FA | 20-216-10 | Ford | 50 |
| E9PF-10346-AA | 20-216-10 | Ford | 50 | F0TU-10300-GA | 20-220-10 | Ford | 51 |
| E9PF-10346-AB | 20-216-10 | Ford | 50 | F0TU-10300-HA | 20-220-10 | Ford | 51 |
| E9PF-10346-BA | 20-208-30-1 | Ford | 51 | F0TZ-11002-A | 50-220-1 | Ford | 64 |
| E9PF-10346-BA | 20-216-30 | Ford | 50 | F0TZ-11002-B | 2-1885-FD-1 | Ford | 62 |
| E9PF-10346-CB | 20-220-10 | Ford | 51 | F0VF-10300-AA | 20-229-31-2 | Ford | 55 |
| E9PZ-10346-A | 20-208-30-1 | Ford | 51 | F0VU-10300-AA | 20-229-31-2 | Ford | 55 |
| E9PZ-10346-A | 20-216-30 | Ford | 50 | F0VU-10300-AB | 20-229-31-2 | Ford | 55 |
| E9PZ-10346-B | 20-216-10 | Ford | 50 | F0VU-10300-AC | 20-229-31-2 | Ford | 55 |
| E9PZ-10346-C | 20-220-10 | Ford | 51 | F0VY-10346-A | 20-229-31-2 | Ford | 55 |
| E9PZ-10346-D | 20-207-30-1 | Ford | 51 | F0VY-10346-B | 20-229-31-2 | Ford | 55 |
| E9PZ-10346-D | 20-220-30 | Ford | 51 | F17U-10300-AA | 20-221-11-2 | Ford | 52 |
| E9SF-10300-BA | 20-208-30-1 | Ford | 51 | F17U-11000-AB | 2-1894-FD-1 | Ford | 63 |
| E9SF-10300-BA | 20-216-30 | Ford | 50 | F1HT-10300-AA | 20-229-11-2 | Ford | 55 |
| E9SF-11000-AA | 2-1806-FD-1 | Ford | 62 | F1HT-10300-AB | 20-229-11-2 | Ford | 55 |
| E9SF-11000-BA | 2-1806-FD-1 | Ford | 62 | F1HT-10300-AC | 20-229-11-2 | Ford | 55 |
| E9SZ-11002-A | 2-1806-FD-1 | Ford | 62 | F1HT-11001-AA | 2-2675-DR | Ford | 42 |
| E9SZ-11002-B | 2-1806-FD-1 | Ford | 62 | F1HZ-11002-A | 2-2675-DR | Ford | 42 |
| E9UF-10300-BA | 20-208-30-1 | Ford | 51 | F1PU-10346-CA | 20-221-10-2 | Ford | 52 |
| E9UF-10300-BA | 20-216-30 | Ford | 50 | F1SU-10300-BA | 20-229-12-2 | Ford | 55 |
| E9UF-10300-DA | 20-216-10 | Ford | 50 | F1TZ-10346-B | 20-221-10-2 | Ford | 52 |
| EDE57F-10300-AA | 20-216-10 | Ford | 50 | F1TZ-10346-C | 20-221-10-2 | Ford | 52 |
| EDE57F-10300-BA | 20-216-10 | Ford | 50 | F1TZ-11002-A | 2-1894-FD-1 | Ford | 63 |
| EDE7AF-10300-BA | 20-208-30-1 | Ford | 51 | F29U-10300-AB | 20-229-12-2 | Ford | 55 |
| EDE7AF-10300-BA | 20-216-30 | Ford | 50 | F2HT-11000-AA | 2-1953-FD-1 | Ford | 63 |
| EDE7DF-10300-GA | 20-207-30-1 | Ford | 51 | F2HT-11000-BA | 2-1956-FD-1 | Ford | 64 |
| EDE7DF-10300-GA | 20-220-30 | Ford | 51 | F2HZ-10346-B | 20-229-10-2 | Ford | 55 |
| EZHT-10346-DB | 20-210-1 | Ford | 50 | F2HZ-11002-A | 2-1953-FD-1 | Ford | 63 |
| F07F-10300-AA | 20-221-11-2 | Ford | 52 | F2HZ-11002-B | 2-1956-FD-1 | Ford | 64 |
| F07U-10300-AA | 20-221-11-2 | Ford | 52 | F2NN-10B376-AA | 1-2454-01MM | Ford | 76 |
| F07U-10300-AB | 20-221-11-2 | Ford | 52 | F2OF-10346-FA | 20-202 | Ford | 49 |
| F07U-10300-AC | 20-221-11-2 | Ford | 52 | F2OF-10346-HA | 20-202 | Ford | 49 |

CROSS REFERENCE

CROSS REFERENCE - REF# to CATALOG#

| Mfr. Part# | Catalog# | Mfr. Name | Pg. # | Mfr. Part# | Catalog# | Mfr. Name | Pg. # |
|---------------|---------------|-----------|-------|---------------|---------------|-----------|-------|
| F2OF-10346-JA | 20-202 | Ford | 49 | F4TZ-11002-B | 2-1747-MI | Ford | 91 |
| F2OF-10346-KA | 20-202 | Ford | 49 | F57U-10300-AA | 20-221-12-2 | Ford | 52 |
| F2PU-10346-AF | 20-228-10-2 | Ford | 54 | F5HT-10300-AA | 20-229-31-2 | Ford | 55 |
| F2PU-10346-DE | 20-226-10-2 | Ford | 53 | F5HT-10300-BA | 20-229-31-2 | Ford | 55 |
| F2PU-10346-FC | 20-229-10-2 | Ford | 55 | F5HT-10300-DA | 1-1997-11FD-2 | Ford | 52 |
| F2PU-10346-GA | 20-225-11-2 | Ford | 53 | F5HZ-10346-A | 1-1915-00DR | Ford | 11 |
| F2TU-10300-AF | 20-228-12-2 | Ford | 54 | F5HZ-10346-B | 1-1918-00DR | Ford | 12 |
| F2TU-10346-AE | 20-228-10-2 | Ford | 54 | F5HZ-10346-E | 20-229-31-2 | Ford | 55 |
| F2TU-11000-AA | 2-1881-FD-1 | Ford | 62 | F5PU-10300-GA | 1-1997-11FD-2 | Ford | 52 |
| F2TU-11000-BA | 2-1883-FD-1 | Ford | 62 | F5PU-10346-EA | 20-229-31-2 | Ford | 55 |
| F2TU-11000-CA | 2-1882-FD-1 | Ford | 62 | F5PZ-10346-GA | 1-1997-11FD-2 | Ford | 52 |
| F2TZ-11002-A | 2-1881-FD-1 | Ford | 62 | F5TU-11000-AA | 2-1748-MI-1 | Ford | 92 |
| F2TZ-11002-B | 2-1883-FD-1 | Ford | 62 | F5TU-11000-AB | 2-1748-MI-1 | Ford | 92 |
| F2TZ-11002-C | 2-1882-FD-1 | Ford | 62 | F5TU-11000-AD | 2-1748-MI-1 | Ford | 92 |
| F2UU-10300-BE | 20-226-12-2 | Ford | 53 | F5UU-10300-AA | 20-228-13-2 | Ford | 54 |
| F2UU-10300-CD | 20-229-14-2 | Ford | 55 | F5UU-10300-BA | 20-228-14-2 | Ford | 55 |
| F2UU-10300-DC | 20-226-11-2 | Ford | 53 | F5UU-10300-CA | 1-1929-01MI | Ford | 83 |
| F2UU-10300-EA | 20-225-11-2 | Ford | 53 | F5UZ-10346-CA | 1-1929-01MI | Ford | 83 |
| F2UU-10300-FA | 20-226-13-2 | Ford | 53 | F65U-10300-BB | 1-1612-33FD-2 | Ford | 52 |
| F2UU-10346-BE | 20-226-10-2 | Ford | 53 | F67U-10300-AA | 20-221-10-2 | Ford | 52 |
| F2UU-10346-CD | 20-229-10-2 | Ford | 55 | F67U-10300-AA | 20-221-11-2 | Ford | 52 |
| F2UU-10346-DA | 20-225-11-2 | Ford | 53 | F67U-10300-BA | 20-221-10-2 | Ford | 52 |
| F2UZ-10346-B | 20-226-10-2 | Ford | 53 | F67U-10300-BA | 20-221-12-2 | Ford | 52 |
| F2UZ-10346-C | 20-225-11-2 | Ford | 53 | F69U-10300-AA | 20-229-12-2 | Ford | 55 |
| F2VU-11000-AC | 2-1799-FD-1 | Ford | 62 | F6AU-10300-AA | 20-239-31-2 | Ford | 56 |
| F2VU-11000-AD | 2-1799-FD-1 | Ford | 62 | F6AU-10300-AB | 20-239-31-2 | Ford | 56 |
| F2VY-11002-A | 2-1799-FD-1 | Ford | 62 | F6AZ-10346-AA | 20-227-30-2 | Ford | 54 |
| F37U-10300-AA | 20-228-11-2 | Ford | 54 | F6HT-10300-FA | 1-2299-00DR | Ford | 13 |
| F3AU-10346-AC | 20-227-30-2 | Ford | 54 | F6HT-10300-JA | 1-2299-00DR | Ford | 13 |
| F3AZ-10346-A | 20-227-30-2 | Ford | 54 | F6HT-10300-KA | 20-229-31-2 | Ford | 55 |
| F3HT-10300-AA | 1-1915-00DR | Ford | 11 | F6HT-10300-LA | 1-1997-11FD-2 | Ford | 52 |
| F3HT-10300-BA | 1-1915-00DR | Ford | 11 | F6HT-10300-MA | 20-229-31-2 | Ford | 55 |
| F3HT-10300-CA | 1-1915-00DR | Ford | 11 | F6HT-11001-AA | 50-153-1 | Ford | 43 |
| F3HT-10300-GB | 1-1997-11FD-2 | Ford | 52 | F6HT-11001-AA | 50-153-2 | Ford | 43 |
| F3HT-10300-HB | 1-1915-00DR | Ford | 11 | F6HT-11001-BA | 2-2471-DR | Ford | 41 |
| F3HT-10300-JB | 1-1918-00DR | Ford | 12 | F6HT-11001-EA | 50-152-1 | Ford | 42 |
| F3HT-10300-LA | 20-232-11-2 | Ford | 56 | F6HT-11001-EA | 50-152-2 | Ford | 42 |
| F3HT-10300-SA | 1-2301-00DR | Ford | 17 | F6HT-11001-FA | 2-2471-DR | Ford | 41 |
| F3HT-10300-TA | 1-2301-00DR | Ford | 17 | F6HT-11001-GA | 50-153-1 | Ford | 43 |
| F3HT-10300-UA | 1-2301-00DR | Ford | 17 | F6HT-11001-GA | 50-153-2 | Ford | 43 |
| F3HT-11001-AB | 50-8428 | Ford | 32 | F6HT-11001-HA | 50-192-1 | Ford | 43 |
| F3HT-11001-AC | 50-8428 | Ford | 32 | F6HT-11001-HA | 50-192-2 | Ford | 43 |
| F3HT-11001-BA | 50-161-1 | Ford | 36 | F6HU-10300-AA | 1-1997-11FD-2 | Ford | 52 |
| F3HT-11001-DB | 50-8425 | Ford | 32 | F6HZ-10346-A | 1-1918-00DR | Ford | 12 |
| F3HT-11001-DC | 50-8425 | Ford | 32 | F6HZ-10346-B | 1-1918-00DR | Ford | 12 |
| F3HZ-10346-A | 1-2301-00DR | Ford | 17 | F6HZ-10346-B | 1-2299-00DR | Ford | 13 |
| F3HZ-10346-B | 20-232-10-2 | Ford | 56 | F6HZ-10346-C | 1-1918-00DR | Ford | 12 |
| F3HZ-10346-E | 1-1918-00DR | Ford | 12 | F6HZ-10346-C | 1-2299-00DR | Ford | 13 |
| F3HZ-10346-H | 1-1915-00DR | Ford | 11 | F6HZ-11002-AA | 50-153-1 | Ford | 43 |
| F3HZ-10346-J | 1-1918-00DR | Ford | 12 | F6HZ-11002-AA | 50-153-2 | Ford | 43 |
| F3HZ-11002-A | 50-8428 | Ford | 32 | F6HZ-11002-BA | 2-2471-DR | Ford | 41 |
| F3HZ-11002-B | 50-8425 | Ford | 32 | F6HZ-11002-EA | 50-152-1 | Ford | 42 |
| F3HZ-11002-C | 50-161-1 | Ford | 36 | F6HZ-11002-EA | 50-152-2 | Ford | 42 |
| F3LU-11000-AA | 2-1799-FD-1 | Ford | 62 | F6HZ-11002-FA | 2-2471-DR | Ford | 41 |
| F3LY-11002-A | 2-1799-FD-1 | Ford | 62 | F6HZ-11002-GA | 50-153-1 | Ford | 43 |
| F3PU-10346-AC | 20-227-30-2 | Ford | 54 | F6HZ-11002-GA | 50-153-2 | Ford | 43 |
| F3PU-10346-BA | 20-232-10-2 | Ford | 56 | F6HZ-11002-HA | 50-192-1 | Ford | 43 |
| F3TU-11000-AA | 2-1254-MI-2 | Ford | 87 | F6HZ-11002-HA | 50-192-2 | Ford | 43 |
| F3UU-10300-AE | 20-228-11-2 | Ford | 54 | F6PU-10346-AF | 20-229-31-2 | Ford | 55 |
| F3UU-10300-AF | 20-228-11-2 | Ford | 54 | F6PU-10346-BA | 20-239-30-2 | Ford | 56 |
| F3UZ-10346-A | 20-228-10-2 | Ford | 54 | F6PU-10346-EB | 20-239-30-2 | Ford | 56 |
| F4HT-10300-DA | 1-1915-00DR | Ford | 11 | F6PU-10346-SA | 1-1997-11FD-2 | Ford | 52 |
| F4HT-10300-EA | 1-1915-00DR | Ford | 11 | F6PU-10346-TA | 20-229-31-2 | Ford | 55 |
| F4HT-10300-FA | 1-1915-00DR | Ford | 11 | F6PU-10346-VA | 20-228-10-2 | Ford | 54 |
| F4HT-10300-KA | 1-1915-00DR | Ford | 11 | F6PZ-10346-AF | 20-229-31-2 | Ford | 55 |
| F4HT-10300-LA | 1-1918-00DR | Ford | 12 | F6PZ-10346-B | 20-239-30-2 | Ford | 56 |
| F4HT-11001-AA | 50-8428 | Ford | 32 | F6PZ-10346-EA | 20-239-30-2 | Ford | 56 |
| F4HT-11001-BA | 50-8425 | Ford | 32 | F6PZ-10346-HA | 20-225-11-2 | Ford | 53 |
| F4LU-11000-AA | 2-1799-FD-1 | Ford | 62 | F6PZ-10346-KA | 20-229-10-2 | Ford | 55 |
| F4PU-11000-AA | 2-1747-MI | Ford | 91 | F6PZ-10346-LA | 20-221-10-2 | Ford | 52 |
| F4PU-11000-AC | 2-1747-MI | Ford | 91 | F6PZ-10346-PA | 20-229-10-2 | Ford | 55 |
| F4TZ-11002-A | 2-1748-MI-1 | Ford | 92 | F6PZ-10346-RA | 20-244-30-2 | Ford | 56 |

CROSS REFERENCE - REF# to CATALOG#

| Mfr. Part No. | Catalog No. | Mfr. Name | Pg. # | Mfr. Part No. | Catalog No. | Mfr. Name | Pg. # |
|----------------|---------------|-----------|-------|----------------|---------------|---------------|-------|
| F6PZ-10346-TA | 20-229-31-2 | Ford | 55 | F7UU-10300-BC | 20-239-30-2 | Ford | 56 |
| F6PZ-10346-XA | 20-226-10-2 | Ford | 53 | F7UU-10300-BC | 20-239-32-2 | Ford | 56 |
| F6UU-10300-AA | 20-225-11-2 | Ford | 53 | F7UU-10300-CB | 20-239-30-2 | Ford | 56 |
| F6UU-10300-BA | 20-229-14-2 | Ford | 55 | F7UU-10300-CB | 20-239-32-2 | Ford | 56 |
| F6UU-10300-CA | 20-228-11-2 | Ford | 54 | F7UU-11000-AA | 2-1799-FD-1 | Ford | 62 |
| F6UU-10300-DA | 20-226-13-2 | Ford | 53 | F7UU-11000-AB | 2-1799-FD-1 | Ford | 62 |
| F6UU-10300-EA | 20-228-14-2 | Ford | 55 | F7UZ-11002-AA | 2-1799-FD-1 | Ford | 62 |
| F6UU-10300-FA | 20-228-12-2 | Ford | 54 | F81U-10300-BC | 1-2270-31FD-2 | Ford | 58 |
| F6UZ-10346-SA | 1-1997-11FD-2 | Ford | 52 | F81U-10300-BD | 1-2270-31FD-2 | Ford | 58 |
| F6UZ-10346-VA | 20-228-10-2 | Ford | 54 | F81U-10300-CC | 1-2172-31FD-2 | Ford | 57 |
| F6VU-11000-AA | 2-1799-FD-1 | Ford | 62 | F81U-10300-CD | 1-2172-31FD-2 | Ford | 57 |
| F6VZ-11002-AA | 2-1799-FD-1 | Ford | 62 | F81U-10300-CE | 1-2172-31FD-2 | Ford | 57 |
| F6ZU-10300-AA | 20-239-31-2 | Ford | 56 | F81U-10300-DB | 1-2209-11FD-2 | Ford | 58 |
| F6ZU-10300-AB | 20-239-31-2 | Ford | 56 | F81U-10300-DC | 1-2209-11FD-2 | Ford | 58 |
| F75U-10300-CA | 20-239-30-2 | Ford | 56 | F81U-10300-DD | 1-2209-11FD-2 | Ford | 58 |
| F75U-10300-CA | 20-239-32-2 | Ford | 56 | F81U-10300-DE | 1-2209-11FD-2 | Ford | 58 |
| F75U-10300-CB | 20-239-30-2 | Ford | 56 | F81U-10300-EB | 1-2173-11FD-2 | Ford | 57 |
| F75U-10300-CB | 20-239-32-2 | Ford | 56 | F81U-10300-GA | 1-2178-31FD-2 | Ford | 57 |
| F75U-11000-AA | 2-1799-FD-1 | Ford | 62 | F81U-11000-AA | 2-1910-FD-1 | Ford | 63 |
| F75U-11000-AB | 2-1799-FD-1 | Ford | 62 | F81U-11000-AB | 2-1910-FD-1 | Ford | 63 |
| F75U-11000-AC | 2-1799-FD-1 | Ford | 62 | F81U-11000-AC | 2-1910-FD-1 | Ford | 63 |
| F75Z-11002-AA | 2-1799-FD-1 | Ford | 62 | F81U-11000-AD | 2-1910-FD-1 | Ford | 63 |
| F77U-11000-AA | 50-237-1 | Ford | 64 | F81U-11000-AE | 2-1910-FD-1 | Ford | 63 |
| F77Z-11002-AA | 50-237-1 | Ford | 64 | F81Z-10346-BA | 1-2270-31FD-2 | Ford | 58 |
| F77Z-11002-AC | 50-237-1 | Ford | 64 | F81Z-10346-CA | 1-2172-31FD-2 | Ford | 57 |
| F7CU-10300-AB | 20-221-10-2 | Ford | 52 | F81Z-10346-DA | 1-2209-11FD-2 | Ford | 58 |
| F7CU-10300-AB | 20-221-12-2 | Ford | 52 | F81Z-10346-EA | 1-2173-11FD-2 | Ford | 57 |
| F7HT-10300-GA | 20-502-1 | Ford | 74 | F81Z-10346-GA | 1-2178-31FD-2 | Ford | 57 |
| F7HT-10300-HA | 20-502-1 | Ford | 74 | F81Z-11000-AC | 2-1910-FD-1 | Ford | 63 |
| F7HT-10300-LA | 20-501-1 | Ford | 73 | F81Z-11002-AA | 2-1910-FD-1 | Ford | 63 |
| F7HT-10300-MA | 20-501-1 | Ford | 73 | F81Z-11002-AC | 2-1910-FD-1 | Ford | 63 |
| F7HT-11001-AB | 2-2051-DR | Ford | 29 | F87U-11000-A1A | 2-1894-FD-1 | Ford | 63 |
| F7HT-11001-AC | 2-2051-DR | Ford | 29 | F87U-11000-A1B | 2-1894-FD-1 | Ford | 63 |
| F7HT-11001-DA | 50-192-1 | Ford | 43 | F87U-11000-AA | 2-1894-FD-1 | Ford | 63 |
| F7HT-11001-DA | 50-192-2 | Ford | 43 | F87U-11000-B1A | 2-1895-FD-1 | Ford | 63 |
| F7HZ-10346-A | 20-119-1 | Ford | 16 | F87U-11000-B1B | 2-1895-FD-1 | Ford | 63 |
| F7HZ-10346-GA | 20-502-1 | Ford | 74 | F87U-11000-BA | 2-1895-FD-1 | Ford | 63 |
| F7HZ-10346-HA | 20-502-1 | Ford | 74 | F87Z-11002-AA | 2-1894-FD-1 | Ford | 63 |
| F7HZ-10346-LA | 20-501-1 | Ford | 73 | F87Z-11002-BA | 2-1895-FD-1 | Ford | 63 |
| F7HZ-10346-MA | 20-501-1 | Ford | 73 | F89U-11000-AA | 2-1887-FD-1 | Ford | 63 |
| F7HZ-11002-AB | 2-2051-DR | Ford | 29 | F89U-11000-AB | 2-1887-FD-1 | Ford | 63 |
| F7HZ-11002-DA | 50-192-1 | Ford | 43 | F89U-11000-BA | 2-1886-FD-1 | Ford | 63 |
| F7HZ-11002-DA | 50-192-2 | Ford | 43 | F89U-11000-BB | 2-1886-FD-1 | Ford | 63 |
| F7LU-11000-AA | 2-1799-FD-1 | Ford | 62 | F89Z-11002-AA | 2-1887-FD-1 | Ford | 63 |
| F7LU-11000-BA | 2-1799-FD-1 | Ford | 62 | F89Z-11002-BA | 2-1886-FD-1 | Ford | 63 |
| F7LU-11001-BA | 2-1799-FD-1 | Ford | 62 | FAC-11000 | 2-2289-FD | Ford | 61 |
| F7LZ-11002-AA | 2-1799-FD-1 | Ford | 62 | FAC-11001 | 2-2289-FD | Ford | 61 |
| F7LZ-11002-BA | 2-1799-FD-1 | Ford | 62 | FAC-11001-B | 2-2289-FD | Ford | 61 |
| F7PU-10346-KA | 20-239-30-2 | Ford | 56 | FAC-11001-G | 2-2289-FD | Ford | 61 |
| F7PU-10346-KA | 20-239-32-2 | Ford | 56 | FAC-11001-H | 2-2289-FD | Ford | 61 |
| F7PU-11000-DA | 2-1953-FD-1 | Ford | 63 | FAC-11001-M | 2-2289-FD | Ford | 61 |
| F7PU-11000-EA | 2-1956-FD-1 | Ford | 64 | FAC-11001-P | 2-2289-FD | Ford | 61 |
| F7PU-11000-FA | 2-1881-FD-1 | Ford | 62 | FAC-11002 | 2-2289-FD | Ford | 61 |
| F7PU-11000-GA | 2-1883-FD-1 | Ford | 62 | FAC-11002-B | 2-2289-FD | Ford | 61 |
| F7PU-11000-HA | 2-1882-FD-1 | Ford | 62 | FAC-11002-G | 2-2289-FD | Ford | 61 |
| F7PU-11000-KA | 2-1885-FD-1 | Ford | 62 | FAG-11002-G | 2-2289-FD | Ford | 61 |
| F7PZ-10346-K | 20-216-10 | Ford | 50 | FAG-11002-M | 2-2289-FD | Ford | 61 |
| F7PZ-10346-KA | 20-239-30-2 | Ford | 56 | FESE-18-400 | 2-1728-MI | Mazda | 85 |
| F7PZ-10346-KA | 20-239-32-2 | Ford | 56 | FESE-18-400 | 2-1728-MI-3 | Mazda | 92 |
| F7PZ-11002-DA | 2-1953-FD-1 | Ford | 63 | FFSC-18-400 | 2-1728-MI-3 | Mazda | 92 |
| F7PZ-11002-EA | 2-1956-FD-1 | Ford | 64 | FFSO-18-400 | 2-1728-MI-3 | Mazda | 92 |
| F7PZ-11002-FA | 2-1881-FD-1 | Ford | 62 | GC123DC4 | 82-6879 | Haldex-Barnes | 117 |
| F7PZ-11002-GA | 2-1883-FD-1 | Ford | 62 | GD001927-E | 1-2315-01 | Hitachi | 68 |
| F7PZ-11002-HA | 2-1882-FD-1 | Ford | 62 | GD102590-A | 1-2316-01HI | Hitachi | 65 |
| F7PZ-11002-KA | 2-1885-FD-1 | Ford | 62 | GD103925-A | 1-2481-01HI | Hitachi | 67 |
| F7SU-11000-A1B | 2-1806-FD-1 | Ford | 62 | GD105700-D | 1-2317-01HI | Hitachi | 66 |
| F7SU-11000-AA | 2-1806-FD-1 | Ford | 62 | GD204293-E | 1-2332-01HI | Hitachi | 66 |
| F7SU-11000-AB | 2-1806-FD-1 | Ford | 62 | GD204296-A | 1-2312-01HI | Hitachi | 65 |
| F7SZ-11002-AA | 2-1806-FD-1 | Ford | 62 | GD205008-E | 1-2332-01HI | Hitachi | 66 |
| F7UU-10300-AB | 20-244-31-2 | Ford | 57 | GD205578-A | 1-2314-01HI | Hitachi | 66 |
| F7UU-10300-BB | 20-239-30-2 | Ford | 56 | GD206512-C | 1-2471-01HI | Hitachi | 67 |
| F7UU-10300-BB | 20-239-32-2 | Ford | 56 | GD207064-A | 1-2313-01HI | Hitachi | 66 |

CROSS REFERENCE

CROSS REFERENCE - REF# to CATALOG#

| Mfr. Part# | Catalog# | Mfr. Name | Pg. # | Mfr. Part# | Catalog# | Mfr. Name | Pg. # |
|------------|--------------|------------|-------|------------|----------------|------------|-------|
| GL-151 | .20-202 | Motorcraft | 49 | GL-253 | .20-208-30-1 | Motorcraft | 51 |
| GL-152 | .20-202 | Motorcraft | 49 | GL-253 | .20-216-30 | Motorcraft | 50 |
| GL-153 | .20-202 | Motorcraft | 49 | GL-258 | .20-220-10 | Motorcraft | 51 |
| GL-167 | .20-202 | Motorcraft | 49 | GL-260 | .20-220-10 | Motorcraft | 51 |
| GL-167-A | .20-202 | Motorcraft | 49 | GL-262-A | .20-207-30-1 | Motorcraft | 51 |
| GL-168 | .20-202 | Motorcraft | 49 | GL-262-A | .20-220-30 | Motorcraft | 51 |
| GL-168-A | .20-202 | Motorcraft | 49 | GL-263 | .20-208-30-1 | Motorcraft | 51 |
| GL-169 | .20-202 | Motorcraft | 49 | GL-263 | .20-216-30 | Motorcraft | 50 |
| GL-169-A | .20-202 | Motorcraft | 49 | GL-264 | .20-210-1 | Motorcraft | 50 |
| GL-189-A | .20-502-1 | Motorcraft | 74 | GL-264-A | .20-210-1 | Motorcraft | 50 |
| GL-197 | .20-202 | Motorcraft | 49 | GL-267 | .20-216-10 | Motorcraft | 50 |
| GL-198 | .20-202 | Motorcraft | 49 | GL-268 | .20-220-10 | Motorcraft | 51 |
| GL-198-A | .20-202 | Motorcraft | 49 | GL-279 | .20-229-31-2 | Motorcraft | 55 |
| GL-200 | .20-202 | Motorcraft | 49 | GL-282 | .20-219-10 | Motorcraft | 51 |
| GL-201 | .20-202 | Motorcraft | 49 | GL-283 | .20-219-10 | Motorcraft | 51 |
| GL-204 | .20-202 | Motorcraft | 49 | GL-288 | .20-210-1 | Motorcraft | 50 |
| GL-204-A | .20-202 | Motorcraft | 49 | GL-289 | .20-210-1 | Motorcraft | 50 |
| GL-212-A | .20-202 | Motorcraft | 49 | GL-292 | .20-1163-1 | Motorcraft | 19 |
| GL-215 | .20-210-1 | Motorcraft | 50 | GL-293 | .20-221-10-2 | Motorcraft | 52 |
| GL-216 | .20-210-1 | Motorcraft | 50 | GL-295 | .20-216-10 | Motorcraft | 50 |
| GL-216-A | .20-210-1 | Motorcraft | 50 | GL-296 | .20-220-10 | Motorcraft | 51 |
| GL-217 | .20-210-1 | Motorcraft | 50 | GL-308 | .20-221-10-2 | Motorcraft | 52 |
| GL-217-A | .20-210-1 | Motorcraft | 50 | GL-311 | .20-229-31-2 | Motorcraft | 55 |
| GL-218 | .20-210-1 | Motorcraft | 50 | GL-317 | .20-227-30-2 | Motorcraft | 54 |
| GL-218-A | .20-210-1 | Motorcraft | 50 | GL-318 | .20-229-10-2 | Motorcraft | 55 |
| GL-222 | .20-207-30-1 | Motorcraft | 51 | GL-319 | .20-226-10-2 | Motorcraft | 53 |
| GL-222 | .20-220-30 | Motorcraft | 51 | GL-321 | .20-225-11-2 | Motorcraft | 53 |
| GL-224 | .20-216-10 | Motorcraft | 50 | GL-325 | .20-232-10-2 | Motorcraft | 56 |
| GL-225 | .20-207-30-1 | Motorcraft | 51 | GL-331 | .20-228-10-2 | Motorcraft | 54 |
| GL-225 | .20-220-30 | Motorcraft | 51 | GL-332 | .1-1915-00DR | Motorcraft | 11 |
| GL-226 | .20-207-30-1 | Motorcraft | 51 | GL-333 | .1-1918-00DR | Motorcraft | 12 |
| GL-226 | .20-220-30 | Motorcraft | 51 | GL-336 | .1-1918-00DR | Motorcraft | 12 |
| GL-228 | .20-207-30-1 | Motorcraft | 51 | GL-349 | .1-2301-00DR | Motorcraft | 17 |
| GL-228 | .20-220-30 | Motorcraft | 51 | GL-351 | .20-239-30-2 | Motorcraft | 56 |
| GL-229 | .20-207-30-1 | Motorcraft | 51 | GL-352 | .20-229-31-2 | Motorcraft | 55 |
| GL-229 | .20-220-30 | Motorcraft | 51 | GL-358 | .1-1915-00DR | Motorcraft | 11 |
| GL-230 | .20-207-30-1 | Motorcraft | 51 | GL-359 | .1-1918-00DR | Motorcraft | 12 |
| GL-230 | .20-220-30 | Motorcraft | 51 | GL-360 | .1-1929-01MI | Motorcraft | 83 |
| GL-230-A | .20-207-30-1 | Motorcraft | 51 | GL-361 | .1-1997-11FD-2 | Motorcraft | 52 |
| GL-230-A | .20-220-30 | Motorcraft | 51 | GL-364 | .1-1918-00DR | Motorcraft | 12 |
| GL-234 | .20-207-30-1 | Motorcraft | 51 | GL-365 | .1-2299-00DR | Motorcraft | 13 |
| GL-234 | .20-220-30 | Motorcraft | 51 | GL-366 | .1-2299-00DR | Motorcraft | 13 |
| GL-234-A | .20-207-30-1 | Motorcraft | 51 | GL-371 | .20-221-10-2 | Motorcraft | 52 |
| GL-234-A | .20-220-30 | Motorcraft | 51 | GL-372 | .20-244-30-2 | Motorcraft | 56 |
| GL-236 | .20-207-30-1 | Motorcraft | 51 | GL-373 | .20-239-30-2 | Motorcraft | 56 |
| GL-236 | .20-220-30 | Motorcraft | 51 | GL-374 | .20-229-10-2 | Motorcraft | 55 |
| GL-236-A | .20-207-30-1 | Motorcraft | 51 | GL-376 | .20-225-11-2 | Motorcraft | 53 |
| GL-236-A | .20-220-30 | Motorcraft | 51 | GL-378 | .20-229-10-2 | Motorcraft | 55 |
| GL-237 | .20-208-30-1 | Motorcraft | 51 | GL-379 | .20-227-30-2 | Motorcraft | 54 |
| GL-237 | .20-216-30 | Motorcraft | 50 | GL-380 | .1-1997-11FD-2 | Motorcraft | 52 |
| GL-238 | .20-216-10 | Motorcraft | 50 | GL-381 | .20-228-10-2 | Motorcraft | 54 |
| GL-238-A | .20-216-10 | Motorcraft | 50 | GL-387 | .20-229-31-2 | Motorcraft | 55 |
| GL-239 | .20-207-30-1 | Motorcraft | 51 | GL-389 | .20-229-31-2 | Motorcraft | 55 |
| GL-239 | .20-220-30 | Motorcraft | 51 | GL-390 | .20-226-10-2 | Motorcraft | 53 |
| GL-240 | .20-207-30-1 | Motorcraft | 51 | GL-397 | .20-502-1 | Motorcraft | 74 |
| GL-240 | .20-207-31-2 | Motorcraft | 50 | GL-398 | .20-502-1 | Motorcraft | 74 |
| GL-240 | .20-220-30 | Motorcraft | 51 | GL-401 | .20-501-1 | Motorcraft | 73 |
| GL-240-A | .20-207-30-1 | Motorcraft | 51 | GL-402 | .20-501-1 | Motorcraft | 73 |
| GL-240-A | .20-207-31-2 | Motorcraft | 50 | GL-409 | .1-2270-31FD-2 | Motorcraft | 58 |
| GL-240-A | .20-220-30 | Motorcraft | 51 | GL-410 | .1-2172-31FD-2 | Motorcraft | 57 |
| GL-241 | .20-208-30-1 | Motorcraft | 51 | GL-411 | .1-2209-11FD-2 | Motorcraft | 58 |
| GL-241 | .20-216-30 | Motorcraft | 50 | GL-412 | .1-2173-11FD-2 | Motorcraft | 57 |
| GL-241-A | .20-208-30-1 | Motorcraft | 51 | GL-417 | .20-239-30-2 | Motorcraft | 56 |
| GL-241-A | .20-216-30 | Motorcraft | 50 | GL-417 | .20-239-32-2 | Motorcraft | 56 |
| GL-244 | .20-216-10 | Motorcraft | 50 | GL-422 | .1-2178-31FD-2 | Motorcraft | 57 |
| GL-244-A | .20-216-10 | Motorcraft | 50 | GL-455 | .1-2350-11FD-2 | Motorcraft | 58 |
| GL-246 | .20-208-30-1 | Motorcraft | 51 | GL-485 | .20-239-30-2 | Motorcraft | 56 |
| GL-246 | .20-216-30 | Motorcraft | 50 | GL-491 | .20-227-30-2 | Motorcraft | 54 |
| GL-248 | .20-208-30-1 | Motorcraft | 51 | GL-496 | .20-221-10-2 | Motorcraft | 52 |
| GL-248 | .20-216-30 | Motorcraft | 50 | GL-497 | .20-244-30-2 | Motorcraft | 56 |
| GL-252 | .20-208-30-1 | Motorcraft | 51 | GL-500 | .20-228-10-2 | Motorcraft | 54 |
| GL-252 | .20-216-30 | Motorcraft | 50 | GL-508 | .20-239-30-2 | Motorcraft | 56 |

CROSS REFERENCE - REF# to CATALOG#

| Mfr. Part No. | Catalog No. | Mfr. Name | Pg. # | Mfr. Part No. | Catalog No. | Mfr. Name | Pg. # |
|---------------|---------------|---------------------|-------|---------------|---------------|-----------|-------|
| GL-508 | 20-239-32-2 | Motorcraft | 56 | LR225-84T | 1-2474-01HI | Hitachi | 67 |
| GL-529 | 1-2504-31FD | Motorcraft | 58 | LRA00101 | 1-2619-01LU | Lucas | 76 |
| GL-530 | 1-2511-11FD-2 | Motorcraft | 58 | LRA00105 | 1-2619-01LU | Lucas | 76 |
| GL-531 | 1-2512-31FD-2 | Motorcraft | 59 | LRA00113 | 1-2619-01LU | Lucas | 76 |
| GL-551 | 1-2531-11FD | Motorcraft | 59 | LRA00147 | 1-2619-01LU | Lucas | 76 |
| GL-556 | 1-2504-31FD | Motorcraft | 58 | LRA00227 | 1-2316-01HI | Lucas | 65 |
| GL-557 | 1-2531-11FD | Motorcraft | 59 | LRA00247 | 1-2754-02LU | Lucas | 77 |
| GL-569 | 1-2531-11FD | Motorcraft | 59 | LRA00374 | 1-2754-02LU | Lucas | 77 |
| GL-579 | 1-2539-31FD | Motorcraft | 59 | LRA00376 | 1-2762-01LU | Lucas | 77 |
| GL-636 | 1-2350-11FD-2 | Motorcraft | 58 | LRA00460 | 1-2762-01LU | Lucas | 77 |
| GL-643 | 1-2667-31FD | Motorcraft | 59 | LRA00461 | 1-2762-01LU | Lucas | 77 |
| GL-644 | 1-2669-31FD | Motorcraft | 59 | LRA00462 | 1-2754-02LU | Lucas | 77 |
| GL-647 | 1-2667-31FD | Motorcraft | 59 | LRA00463 | 1-2754-02LU | Lucas | 77 |
| GL-648 | 1-2669-31FD | Motorcraft | 59 | LRA00602 | 1-2762-01LU | Lucas | 77 |
| GL-652 | 1-2539-31FD | Motorcraft | 59 | LRA00653 | 1-2754-02LU | Lucas | 77 |
| GL-653 | 1-2350-11FD-2 | Motorcraft | 58 | LRA00685 | 1-2391-01MI | Lucas | 83 |
| GL-88-A | 20-202 | Motorcraft | 49 | LRA00693 | 1-2754-02LU | Lucas | 77 |
| GL-89-A | 20-202 | Motorcraft | 49 | LRA00935 | 1-2721-01LU | Lucas | 77 |
| GL-908 | 1-2539-31FD | Motorcraft | 59 | LRA00958 | 1-2762-01LU | Lucas | 77 |
| GL-922 | 1-2539-31FD | Motorcraft | 59 | LRA00977 | 1-2711-00BO | Lucas | 2 |
| GL-923 | 1-2350-11FD-2 | Motorcraft | 58 | LRA01025 | 1-1806-12FD | Lucas | 49 |
| GL-94-C | 20-209-9 | Motorcraft | 50 | LRA01079 | 20-412 | Lucas | 75 |
| GL-95-A | 20-202 | Motorcraft | 49 | LRA01119 | 1-1504-05ND-2 | Lucas | 95 |
| HM02223 | 82-7859 | United Technologies | 120 | LRA01132 | 1-1503-01ND-2 | Lucas | 95 |
| JR775004 | 20-102-1 | Jeep-Eagle | 10 | LRA01139 | 1-1503-05ND-2 | Lucas | 95 |
| JR775006 | 20-102-1 | Jeep-Eagle | 10 | LRA01139 | 1-1503-06ND-2 | Lucas | 95 |
| JR775006 | 20-102-5 | Jeep-Eagle | 10 | LRA01145 | 1-1504-01ND-2 | Lucas | 95 |
| JR775013 | 2-1413-DR | Jeep-Eagle | 47 | LRA01161 | 1-2227-02BO | Lucas | 1 |
| K7561-61810 | 2-2656-ND | Kubota | 109 | LRA01161 | 1-2227-02ND-2 | Lucas | 97 |
| K7561-61811 | 2-2656-ND | Kubota | 109 | LRA01163 | 1-2227-01ND | Lucas | 96 |
| LR120-23 | 1-2313-01HI | Hitachi | 66 | LRA01165 | 1-2225-01ND-2 | Lucas | 96 |
| LR135-115 | 1-2332-01HI | Hitachi | 66 | LRA01191 | 1-2312-01HI | Lucas | 65 |
| LR135-116 | 1-2332-01HI | Hitachi | 66 | LRA01215 | 1-2481-01HI | Lucas | 67 |
| LR135-127 | 1-2332-01HI | Hitachi | 66 | LRA01218 | 1-1112-01 | Lucas | 65 |
| LR135-44 | 1-1112-01 | Hitachi | 65 | LRA01229 | 1-2236-10ND | Lucas | 97 |
| LR135-58 | 1-2312-01HI | Hitachi | 65 | LRA01288 | 1-2314-01HI | Lucas | 66 |
| LR135-58B | 1-2312-01HI | Hitachi | 65 | LRA01297 | 1-2313-01HI | Lucas | 66 |
| LR135-61B | 1-1112-01 | Hitachi | 65 | LRA01298 | 1-1946-01ND | Lucas | 97 |
| LR135-86 | 1-2332-01HI | Hitachi | 66 | LRA01299 | 1-2462-31MD | Lucas | 82 |
| LR135-86C | 1-2332-01HI | Hitachi | 66 | LRA01367 | 1-2456-01ND | Lucas | 99 |
| LR135-86F | 1-2332-01HI | Hitachi | 66 | LRA01374 | 1-2454-01MM | Lucas | 76 |
| LR135-91 | 1-2314-01HI | Hitachi | 66 | LRA01430 | 1-2482-01HI | Lucas | 67 |
| LR135-95 | 1-2332-01HI | Hitachi | 66 | LRA01441 | 20-145-31-1 | Lucas | 23 |
| LR135-95B | 1-2332-01HI | Hitachi | 66 | LRA01445 | 20-142-11-1 | Lucas | 22 |
| LR138-01 | 1-1112-01 | Hitachi | 65 | LRA01451 | 20-145-11-1 | Lucas | 23 |
| LR140-130 | 1-2481-01HI | Hitachi | 67 | LRA01508 | 1-1802-42DR-1 | Lucas | 26 |
| LR140-130B | 1-2481-01HI | Hitachi | 67 | LRA01543 | 1-2392-01MI | Lucas | 84 |
| LR140-130P | 1-2481-01HI | Hitachi | 67 | LRA01560 | 1-2336-01ND | Lucas | 98 |
| LR140-714 | 1-2315-01 | Hitachi | 68 | LRA01560 | 1-2476-01ND | Lucas | 99 |
| LR140-714B | 1-2315-01 | Hitachi | 68 | LRA01560 | 1-2477-01ND | Lucas | 99 |
| LR145-707 | 1-2469-01HI | Hitachi | 68 | LRA01560 | 1-2478-01ND | Lucas | 99 |
| LR165-03 | 1-2317-01HI | Hitachi | 66 | LRA01655 | 20-110-2 | Lucas | 10 |
| LR170-401 | 1-1940-01HI | Hitachi | 65 | LRA01697 | 1-2821-01ND-2 | Lucas | 99 |
| LR170-410 | 1-1940-01HI | Hitachi | 65 | LRA01719 | 1-2132-01ND | Lucas | 98 |
| LR170-410B | 1-1940-01HI | Hitachi | 65 | LRA01719 | 1-2132-01ND-2 | Lucas | 98 |
| LR170-415 | 1-2482-01HI | Hitachi | 67 | LRA01727 | 1-1802-31DR-1 | Lucas | 26 |
| LR170-415B | 1-2482-01HI | Hitachi | 67 | LRA01792 | 1-1802-21DR-1 | Lucas | 25 |
| LR170-418 | 1-2271-01HI | Hitachi | 65 | LRA01810 | 20-145-21-1 | Lucas | 23 |
| LR170-418B | 1-2271-01HI | Hitachi | 65 | LRA01822 | 20-102-1 | Lucas | 10 |
| LR170-418C | 1-2271-01HI | Hitachi | 65 | LRA01826 | 1-2332-01HI | Lucas | 66 |
| LR180-502 | 1-2470-01HI | Hitachi | 66 | LRA01879 | 1-2589-01BO | Lucas | 3 |
| LR180-502B | 1-2470-01HI | Hitachi | 66 | LRA01909 | 1-2823-01ND-2 | Lucas | 100 |
| LR180-503B | 1-2495-01HI | Hitachi | 68 | LRA01934 | 1-2439-01ND | Lucas | 98 |
| LR180-503C | 1-2495-01HI | Hitachi | 68 | LRA01950 | 1-2315-01 | Lucas | 68 |
| LR180-509 | 1-2358-01HI | Hitachi | 66 | LRA01994 | 1-2062-01MI | Lucas | 84 |
| LR180-509C | 1-2358-01HI | Hitachi | 66 | LRA02043 | 1-1960-01MI | Lucas | 84 |
| LR180-510 | 1-2496-01HI | Hitachi | 68 | LRA02179 | 1-2480-01MI | Lucas | 85 |
| LR220-23 | 1-2471-01HI | Hitachi | 67 | LRA02293 | 1-2768-01BO | Lucas | 3 |
| LR220-24 | 1-2471-01HI | Hitachi | 67 | LRA02413 | 1-2475-01HI | Lucas | 65 |
| LR220-26 | 1-2472-01HI | Hitachi | 67 | LRA02430 | 1-2822-01ND-2 | Lucas | 99 |
| LR220-27 | 1-2473-01HI | Hitachi | 67 | LRA02434 | 1-2614-01VA | Lucas | 112 |
| LR220-27B | 1-2473-01HI | Hitachi | 67 | LRA02438 | 1-2434-01MI | Lucas | 83 |

CROSS REFERENCE

CROSS REFERENCE - REF# to CATALOG#

| Mfr. Part# | Catalog# | Mfr. Name | Pg. # | Mfr. Part# | Catalog# | Mfr. Name | Pg. # |
|------------|---------------|-----------|-------|------------|-------------|-----------|-------|
| LRA02461 | 20-121-1 | Lucas | 16 | LRS00500 | 2-1728-MI | Lucas | 85 |
| LRA02479 | 20-118-1 | Lucas | 11 | LRS00500 | 2-1728-MI-3 | Lucas | 92 |
| LRA02497 | 20-127-1 | Lucas | 18 | LRS00553 | 2-2282-LU | Lucas | 80 |
| LRA02531 | 1-2473-01HI | Lucas | 67 | LRS00555 | 2-2686-LU | Lucas | 79 |
| LRA02615 | 1-2119-11ND | Lucas | 98 | LRS00569 | 50-9107 | Lucas | 6 |
| LRA02615 | 1-2119-11ND-9 | Lucas | 98 | LRS00615 | 2-1193-ND | Lucas | 101 |
| LRA02616 | 1-2436-01ND | Lucas | 98 | LRS00620 | 2-2687-LU | Lucas | 81 |
| LRA02688 | 1-2435-01BO | Lucas | 73 | LRS00691 | 2-2458-LU | Lucas | 81 |
| LRA02731 | 1-2344-00BO | Lucas | 2 | LRS00691 | 2-2458-LU-1 | Lucas | 81 |
| LRA02779 | 1-2711-00BO | Lucas | 2 | LRS00706 | 2-2459-LU | Lucas | 81 |
| LRB00122 | 1-2754-02LU | Lucas | 77 | LRS00741 | 2-2238-ND | Lucas | 107 |
| LRB00137 | 1-2711-00BO | Lucas | 2 | LRS00762 | 50-9124-1 | Lucas | 7 |
| LRB00137 | 1-2711-01BO | Lucas | 2 | LRS00818 | 2-2297-BO | Lucas | 4 |
| LRB00153 | 1-2479-01MI | Lucas | 84 | LRS00837 | 2-2283-BO | Lucas | 4 |
| LRB00186 | 1-2741-01VA | Lucas | 112 | LRS00839 | 50-9108 | Lucas | 6 |
| LRB00286 | 1-2454-01MM | Lucas | 76 | LRS00840 | 2-2284-BO | Lucas | 4 |
| LRB00291 | 1-2730-00LU | Lucas | 77 | LRS00841 | 50-9122-1 | Lucas | 7 |
| LRB00294 | 1-2435-01BO | Lucas | 73 | LRS00850 | 2-2325-BO | Lucas | 5 |
| LRB00302 | 1-2711-00BO | Lucas | 2 | LRS00903 | 2-1729-MI | Lucas | 85 |
| LRB00305 | 1-2237-00BO | Lucas | 2 | LRS00923 | 50-9110-1 | Lucas | 7 |
| LRD00103 | 3-1005-01LU | Lucas | 77 | LRS00968 | 2-2458-LU | Lucas | 81 |
| LRS00106 | 2-2304-LU | Lucas | 81 | LRS00968 | 2-2458-LU-1 | Lucas | 81 |
| LRS00106 | 2-2304-LU-1 | Lucas | 81 | LRS00969 | 2-2340-LU | Lucas | 81 |
| LRS00107 | 2-2687-LU | Lucas | 81 | LRS00969 | 2-2340-LU-1 | Lucas | 81 |
| LRS00115 | 50-9200 | Lucas | 82 | LRS01056 | 2-2277-ND | Lucas | 101 |
| LRS00115 | 50-9200-1 | Lucas | 82 | LRS01058 | 2-2044-ND | Lucas | 100 |
| LRS00115 | 50-9200-2 | Lucas | 82 | LRS01058 | 2-2276-ND | Lucas | 101 |
| LRS00124 | 2-2301-LU | Lucas | 78 | LRS01078 | 2-1193-HI | Lucas | 69 |
| LRS00132 | 2-2304-LU | Lucas | 81 | LRS01098 | 2-1734-HI | Lucas | 70 |
| LRS00132 | 2-2304-LU-1 | Lucas | 81 | LRS01103 | 50-9105-1 | Lucas | 6 |
| LRS00134 | 50-9200 | Lucas | 82 | LRS01111 | 2-2014-HI | Lucas | 70 |
| LRS00134 | 50-9200-1 | Lucas | 82 | LRS01119 | 2-1444-MI | Lucas | 92 |
| LRS00134 | 50-9200-2 | Lucas | 82 | LRS01146 | 2-2089-MI | Lucas | 86 |
| LRS00137 | 2-2340-LU | Lucas | 81 | LRS01153 | 2-1855-HI | Lucas | 69 |
| LRS00137 | 2-2340-LU-1 | Lucas | 81 | LRS01163 | 2-2006-HI | Lucas | 70 |
| LRS00138 | 2-2295-LU | Lucas | 78 | LRS01170 | 2-2235-HI | Lucas | 71 |
| LRS00138 | 2-2295-LU-1 | Lucas | 78 | LRS01187 | 50-8429 | Lucas | 32 |
| LRS00155 | 2-2295-LU | Lucas | 78 | LRS01189 | 2-1781-MI | Lucas | 88 |
| LRS00155 | 2-2295-LU-1 | Lucas | 78 | LRS01194 | 2-1753-ND | Lucas | 103 |
| LRS00161 | 2-2458-LU | Lucas | 81 | LRS01198 | 2-1776-HI | Lucas | 70 |
| LRS00161 | 2-2458-LU-1 | Lucas | 81 | LRS01230 | 50-8404 | Lucas | 29 |
| LRS00162 | 2-2340-LU | Lucas | 81 | LRS01241 | 2-2239-ND | Lucas | 107 |
| LRS00162 | 2-2340-LU-1 | Lucas | 81 | LRS01251 | 2-2735-ND-2 | Lucas | 111 |
| LRS00170 | 2-2300-LU | Lucas | 78 | LRS01255 | 2-1254-MI-2 | Lucas | 87 |
| LRS00170 | 2-2300-LU-1 | Lucas | 78 | LRS01255 | 2-1747-MI | Lucas | 91 |
| LRS00172 | 50-9202 | Lucas | 79 | LRS01256 | 2-1726-ND-2 | Lucas | 102 |
| LRS00182 | 50-9101-1 | Lucas | 6 | LRS01264 | 50-8423 | Lucas | 31 |
| LRS00190 | 2-2302-LU | Lucas | 79 | LRS01274 | 50-8426 | Lucas | 32 |
| LRS00190 | 2-2302-LU-1 | Lucas | 79 | LRS01275 | 2-1413-DR | Lucas | 47 |
| LRS00195 | 2-2458-LU | Lucas | 81 | LRS01275 | 2-1470-DR | Lucas | 47 |
| LRS00195 | 2-2458-LU-1 | Lucas | 81 | LRS01276 | 2-2362-BO | Lucas | 8 |
| LRS00212 | 50-9200 | Lucas | 82 | LRS01284 | 2-1593-DR | Lucas | 48 |
| LRS00212 | 50-9200-1 | Lucas | 82 | LRS01284 | 2-1604-DR | Lucas | 48 |
| LRS00212 | 50-9200-2 | Lucas | 82 | LRS01294 | 2-1780-MI | Lucas | 88 |
| LRS00215 | 2-2305-LU | Lucas | 79 | LRS01294 | 2-2569-MI | Lucas | 93 |
| LRS00232 | 2-2281-LU | Lucas | 79 | LRS01314 | 2-2655-ND | Lucas | 109 |
| LRS00232 | 2-2281-LU-1 | Lucas | 79 | LRS01319 | 2-1733-MI | Lucas | 88 |
| LRS00232 | 2-2290-LU | Lucas | 80 | LRS01321 | 2-2690-BO | Lucas | 9 |
| LRS00240 | 2-2303-LU | Lucas | 80 | LRS01332 | 2-1960-ND | Lucas | 104 |
| LRS00240 | 50-8436 | Lucas | 33 | LRS01332 | 2-2660-ND | Lucas | 109 |
| LRS00300 | 2-2281-LU | Lucas | 79 | LRS01333 | 2-2107-ND | Lucas | 105 |
| LRS00300 | 2-2281-LU-1 | Lucas | 79 | LRS01337 | 2-1612-MI | Lucas | 88 |
| LRS00301 | 2-2292-LU | Lucas | 80 | LRS01337 | 2-1612-MI-2 | Lucas | 88 |
| LRS00305 | 2-2340-LU | Lucas | 81 | LRS01344 | 2-2088-MI | Lucas | 86 |
| LRS00305 | 2-2340-LU-1 | Lucas | 81 | LRS01380 | 2-1727-MI | Lucas | 85 |
| LRS00306 | 2-2340-LU | Lucas | 81 | LRS01384 | 50-8403 | Lucas | 29 |
| LRS00306 | 2-2340-LU-1 | Lucas | 81 | LRS01387 | 2-1750-ND | Lucas | 103 |
| LRS00320 | 2-1741-1 | Lucas | 86 | LRS01396 | 2-1398-ND-2 | Lucas | 102 |
| LRS00375 | 2-2687-LU | Lucas | 81 | LRS01401 | 50-8402-2 | Lucas | 29 |
| LRS00396 | 2-1740-MI | Lucas | 86 | LRS01402 | 2-2024-MI | Lucas | 89 |
| LRS00435 | 50-9100-1 | Lucas | 5 | LRS01408 | 50-157-9 | Lucas | 28 |
| LRS00479 | 2-2687-LU | Lucas | 81 | LRS01408 | 50-8420 | Lucas | 31 |

CROSS REFERENCE

CROSS REFERENCE - REF# to CATALOG#

| Mfr. Part No. | Catalog No. | Mfr. Name | Pg. # | Mfr. Part No. | Catalog No. | Mfr. Name | Pg. # |
|---------------|-------------|------------|-------|---------------|-------------|--------------|-------|
| LRS01412 | 2-1474-DR-2 | Lucas | 46 | M0T65381 | 2-2698-MI | Mitsubishi | 93 |
| LRS01425 | 2-1748-MI-1 | Lucas | 92 | M0T84381 | 2-1728-MI-3 | Mitsubishi | 92 |
| LRS01428 | 2-2086-MI | Lucas | 92 | M1039900 | 82-6880 | Fenner Stone | 117 |
| LRS01442 | 2-1736-HI-1 | Lucas | 68 | M1049992 | 82-6880 | Fenner Stone | 117 |
| LRS01449 | 2-2232-ND | Lucas | 107 | M1T60081 | 2-1444-MI | Mitsubishi | 92 |
| LRS01457 | 2-1946-BO | Lucas | 7 | M1T60081 | 2-1444-MI-9 | Mitsubishi | 92 |
| LRS01468 | 2-2102-MI | Lucas | 90 | M1T60381 | 2-1444-MI | Mitsubishi | 92 |
| LRS01478 | 2-1732-MI-1 | Lucas | 88 | M1T60381 | 2-1444-MI-9 | Mitsubishi | 92 |
| LRS01499 | 2-2355-BO | Lucas | 8 | M1T66081 | 2-2569-MI | Mitsubishi | 93 |
| LRS01499 | 2-2355-BO-1 | Lucas | 8 | M1T79681 | 2-1996-MI | Mitsubishi | 92 |
| LRS01505 | 2-1526-ND | Lucas | 102 | M1T79781 | 2-1996-MI | Mitsubishi | 92 |
| LRS01522 | 2-1996-MI | Lucas | 92 | M1T80081 | 2-2638 | Mitsubishi | 93 |
| LRS01544 | 2-1963-MI | Lucas | 89 | M1T80082 | 2-2638 | Mitsubishi | 93 |
| LRS01547 | 2-1960-ND-2 | Lucas | 104 | M1T90281 | 2-2638 | Mitsubishi | 93 |
| LRS01553 | 2-2311-HI | Lucas | 72 | M2T32581 | 2-1554-MI | Mitsubishi | 85 |
| LRS01572 | 50-193-1 | Lucas | 36 | M2T32581 | 2-1554-MI-1 | Mitsubishi | 85 |
| LRS01580 | 2-2553-BO | Lucas | 8 | M2T43481 | 2-1554-MI | Mitsubishi | 85 |
| LRS01609 | 2-2318-HI | Lucas | 72 | M2T43481 | 2-1554-MI-1 | Mitsubishi | 85 |
| LRS01614 | 2-2012-HI | Lucas | 70 | M2T43681 | 2-1554-MI | Mitsubishi | 85 |
| LRS01626 | 2-2705-ND-2 | Lucas | 109 | M2T43681 | 2-1554-MI-1 | Mitsubishi | 85 |
| LRS01663 | 2-2733-ND-2 | Lucas | 110 | M2T43781 | 2-1554-MI | Mitsubishi | 85 |
| LRS01787 | 2-1737-ND | Lucas | 103 | M2T43781 | 2-1554-MI-1 | Mitsubishi | 85 |
| LRS01811 | 2-2104-ND | Lucas | 105 | M2T43881 | 2-1554-MI | Mitsubishi | 85 |
| LRS01834 | 2-2230-HI | Lucas | 71 | M2T43881 | 2-1554-MI-1 | Mitsubishi | 85 |
| LRS01834 | 2-2231-HI | Lucas | 71 | M2T54085 | 2-1780-MI | Mitsubishi | 88 |
| LRS01837 | 50-104-1 | Lucas | 41 | M2T54091 | 2-1780-MI | Mitsubishi | 88 |
| LRS01837 | 50-104-2 | Lucas | 41 | M2T54571 | 2-2024-MI | Mitsubishi | 89 |
| LRS01839 | 2-2220-MI | Lucas | 90 | M2T54572 | 2-2024-MI | Mitsubishi | 89 |
| LRS01840 | 2-2106-ND | Lucas | 105 | M2T55971 | 2-2093-MI | Mitsubishi | 90 |
| LRS01842 | 2-2103-MI | Lucas | 90 | M2T56071 | 2-1732-MI-1 | Mitsubishi | 88 |
| LRS01843 | 2-2229-MI | Lucas | 91 | M2T56072 | 2-1732-MI-1 | Mitsubishi | 88 |
| LRS01845 | 2-2299-BO | Lucas | 5 | M2T56272 | 2-1781-MI | Mitsubishi | 88 |
| LRS01848 | 2-2101-MI | Lucas | 90 | M2T56471 | 2-1963-MI | Mitsubishi | 89 |
| LRS01854 | 50-103-1 | Lucas | 41 | M2T56472 | 2-1963-MI | Mitsubishi | 89 |
| LRS01854 | 50-103-2 | Lucas | 40 | M2T58381 | 2-1733-MI | Mitsubishi | 88 |
| LRS01861 | 2-2037-HI | Lucas | 70 | M2T58581 | 2-1612-MI | Mitsubishi | 88 |
| LRS01872 | 2-2105-ND | Lucas | 105 | M2T58581 | 2-1612-MI-2 | Mitsubishi | 88 |
| LRS01881 | 2-1754-ND | Lucas | 103 | M2T58681 | 2-1612-MI-2 | Mitsubishi | 88 |
| LRS01889 | 2-2087-MI | Lucas | 89 | M2T58881 | 2-1612-MI | Mitsubishi | 88 |
| LRS01889 | 2-2087-MI-1 | Lucas | 89 | M2T58881 | 2-1612-MI-2 | Mitsubishi | 88 |
| LRS01911 | 2-2100-HI | Lucas | 71 | M2T58981 | 2-1780-MI | Mitsubishi | 88 |
| LRS01915 | 50-151-1 | Lucas | 42 | M2T60271 | 2-1963-MI | Mitsubishi | 89 |
| LRS01915 | 50-151-2 | Lucas | 42 | M2T61371 | 2-1963-MI | Mitsubishi | 89 |
| LRS01915 | 50-151-3 | Lucas | 42 | M2T61771 | 2-2228-MI | Mitsubishi | 91 |
| LRS01917 | 2-2285-BO | Lucas | 4 | M2T62271 | 2-2102-MI | Mitsubishi | 90 |
| LRS01941 | 2-1913-MI-1 | Lucas | 89 | M2T62272 | 2-2102-MI | Mitsubishi | 90 |
| LRS01941 | 2-2092-MI | Lucas | 89 | M2T63371 | 2-2227-MI | Mitsubishi | 91 |
| LRS01974 | 50-9117 | Lucas | 7 | M2T63371 | 2-2227-MI-2 | Mitsubishi | 91 |
| LRS01978 | 50-9109-1 | Lucas | 6 | M2T64272 | 2-2220-MI | Mitsubishi | 90 |
| LRS02064 | 2-2355-BO-1 | Lucas | 8 | M2T64371 | 2-2101-MI | Mitsubishi | 90 |
| LRS02067 | 2-2099-ND | Lucas | 105 | M2T64372 | 2-2101-MI | Mitsubishi | 90 |
| LRS02100 | 2-2638 | Lucas | 93 | M2T64373 | 2-2101-MI | Mitsubishi | 90 |
| LRS02152 | 2-2680-BO | Lucas | 5 | M2T65271 | 2-2103-MI | Mitsubishi | 90 |
| LRS02190 | 2-1724-HI-1 | Lucas | 68 | M2T65272 | 2-2103-MI | Mitsubishi | 90 |
| LRS02210 | 50-162-1 | Lucas | 36 | M2T65275 | 2-2103-MI | Mitsubishi | 90 |
| LRS02238 | 2-2317-HI | Lucas | 69 | M2T65971 | 2-2652-MI | Mitsubishi | 91 |
| LRS883 | 50-9115 | Lucas | 7 | M2T67871 | 2-2229-MI | Mitsubishi | 91 |
| LRS922 | 50-9117 | Lucas | 7 | M2T67881 | 2-2229-MI | Mitsubishi | 91 |
| LRT00134 | 2-2355-BO | Lucas | 8 | M3M10476 | 2-1728-MI | Mitsubishi | 85 |
| LRT00134 | 2-2355-BO-1 | Lucas | 8 | M3M10476 | 2-1728-MI-3 | Mitsubishi | 92 |
| LRT00138 | 2-2463-BO | Lucas | 8 | M3T10473 | 2-2706-MI | Mitsubishi | 86 |
| LRT00225 | 2-2770-NK | Lucas | 94 | M3T10475 | 2-2706-MI | Mitsubishi | 86 |
| LT135-24 | 1-1111-02HI | Hitachi | 64 | M3T10476 | 2-1728-MI | Mitsubishi | 85 |
| LT135-24B | 1-1111-02HI | Hitachi | 64 | M3T10476D | 2-1728-MI | Mitsubishi | 85 |
| LT135-73 | 1-1111-02HI | Hitachi | 64 | M3T10476D | 2-1728-MI-3 | Mitsubishi | 92 |
| LT135-73B | 1-1111-02HI | Hitachi | 64 | M3T10977 | 2-1738-MI-1 | Mitsubishi | 86 |
| LT135-83B | 1-2316-01HI | Hitachi | 65 | M3T11172 | 2-1729-MI | Mitsubishi | 85 |
| LT135-87 | 1-1111-02HI | Hitachi | 64 | M3T11174 | 2-1729-MI | Mitsubishi | 85 |
| LT215-37C | 1-2475-01HI | Hitachi | 65 | M3T11272 | 2-1741-1 | Mitsubishi | 86 |
| M0T21271 | 2-2725-MI | Mitsubishi | 93 | M3T15971 | 2-1727-MI | Mitsubishi | 85 |
| M0T21271ZC | 2-2725-MI | Mitsubishi | 93 | M3T21281 | 2-1740-MI | Mitsubishi | 86 |
| M0T21371 | 2-2697-MI | Mitsubishi | 93 | M3T21281D | 2-1740-MI | Mitsubishi | 86 |

CROSS REFERENCE

CROSS REFERENCE - REF# to CATALOG#

| Mfr. Part# | Catalog# | Mfr. Name | Pg. # | Mfr. Part# | Catalog# | Mfr. Name | Pg. # |
|------------|-------------|------------|-------|------------|-------------|-------------------|-------|
| M3T21282 | 2-1740-MI | Mitsubishi | 86 | MBJ-4201 | 82-6884 | Prestolite | 122 |
| M3T21781 | 2-1740-MI | Mitsubishi | 86 | MBJ-4202 | 82-6868-1 | Prestolite | 121 |
| M3T21781D | 2-1740-MI | Mitsubishi | 86 | MBJ-4202 | 82-6868-2 | Prestolite | 122 |
| M3T21881 | 2-1740-MI | Mitsubishi | 86 | MBJ-4202 | 82-6868-3 | Prestolite | 122 |
| M3T21881D | 2-1740-MI | Mitsubishi | 86 | MBJ-4202 | 82-6884 | Prestolite | 122 |
| M3T21882 | 2-1740-MI | Mitsubishi | 86 | MBJ-4209 | 82-6868-1 | Prestolite | 121 |
| M3T21882D | 2-1740-MI | Mitsubishi | 86 | MBJ-4209 | 82-6868-2 | Prestolite | 122 |
| M3T24917 | 2-1727-MI | Mitsubishi | 85 | MBJ-4209 | 82-6868-3 | Prestolite | 122 |
| M3T25181 | 2-1740-MI | Mitsubishi | 86 | MBJ-4209 | 82-6884 | Prestolite | 122 |
| M3T25981 | 2-1727-MI | Mitsubishi | 85 | MBJ-4401 | 82-6866 | Prestolite | 121 |
| M3T30981 | 2-2088-MI | Mitsubishi | 86 | MBJ-4401S | 82-6866 | Prestolite | 121 |
| M3T32681 | 2-1727-MI | Mitsubishi | 85 | MBJ-4402 | 82-6868-1 | Prestolite | 121 |
| M3T38581 | 2-1740-MI | Mitsubishi | 86 | MBJ-4402 | 82-6868-2 | Prestolite | 122 |
| M3T38682 | 2-1740-MI | Mitsubishi | 86 | MBJ-4402 | 82-6868-3 | Prestolite | 122 |
| M3T41181 | 2-1740-MI | Mitsubishi | 86 | MBJ-4402 | 82-6884 | Prestolite | 122 |
| M3T42881 | 2-1727-MI | Mitsubishi | 85 | MBJ-4404 | 82-6866 | Prestolite | 121 |
| M3T54071 | 2-2103-MI | Mitsubishi | 90 | MBJ-4405 | 82-6868-1 | Prestolite | 121 |
| M3T54072 | 2-2103-MI | Mitsubishi | 90 | MBJ-4405 | 82-6868-2 | Prestolite | 122 |
| M3T56071 | 2-1913-MI-1 | Mitsubishi | 89 | MBJ-4405 | 82-6868-3 | Prestolite | 122 |
| M3T56072 | 2-1913-MI-1 | Mitsubishi | 89 | MBJ-4405 | 82-6884 | Prestolite | 122 |
| M3T56076 | 2-2092-MI | Mitsubishi | 89 | MBJ-4407 | 82-6868-1 | Prestolite | 121 |
| M3T56082 | 2-1913-MI-1 | Mitsubishi | 89 | MBJ-4407 | 82-6868-2 | Prestolite | 122 |
| M3T56172 | 2-2087-MI | Mitsubishi | 89 | MBJ-4407 | 82-6868-3 | Prestolite | 122 |
| M3T56172 | 2-2087-MI-1 | Mitsubishi | 89 | MBJ-4407 | 82-6884 | Prestolite | 122 |
| M3T56174 | 2-2087-MI | Mitsubishi | 89 | MBJ-4411 | 82-6868-1 | Prestolite | 121 |
| M3T56174 | 2-2087-MI-1 | Mitsubishi | 89 | MBJ-4411 | 82-6868-2 | Prestolite | 122 |
| M3T56181 | 2-2087-MI | Mitsubishi | 89 | MBJ-4411 | 82-6868-3 | Prestolite | 122 |
| M3T56181 | 2-2087-MI-1 | Mitsubishi | 89 | MBJ-4411 | 82-6884 | Prestolite | 122 |
| M3T56182 | 2-2087-MI | Mitsubishi | 89 | MBJ-4412 | 82-6868-1 | Prestolite | 121 |
| M3T56182 | 2-2087-MI-1 | Mitsubishi | 89 | MBJ-4412 | 82-6868-2 | Prestolite | 122 |
| M3T56183 | 2-2087-MI | Mitsubishi | 89 | MBJ-4412 | 82-6868-3 | Prestolite | 122 |
| M3T56183 | 2-2087-MI-1 | Mitsubishi | 89 | MBJ-4412 | 82-6884 | Prestolite | 122 |
| M3T64172 | 2-1963-MI | Mitsubishi | 89 | MBJ-4415 | 82-6868-1 | Prestolite | 121 |
| M3T90071 | 2-1254-MI-2 | Mitsubishi | 87 | MBJ-4415 | 82-6868-2 | Prestolite | 122 |
| M3T90072 | 2-1254-MI-2 | Mitsubishi | 87 | MBJ-4415 | 82-6868-3 | Prestolite | 122 |
| M3T90271 | 2-2094-MI | Mitsubishi | 90 | MBJ-4415 | 82-6884 | Prestolite | 122 |
| M3T90272 | 2-2094-MI | Mitsubishi | 90 | MBJ-4416 | 82-6868-1 | Prestolite | 121 |
| M3T90273 | 2-2094-MI | Mitsubishi | 90 | MBJ-4416 | 82-6868-2 | Prestolite | 122 |
| M4T14674 | 2-2089-MI | Mitsubishi | 86 | MBJ-4416 | 82-6868-3 | Prestolite | 122 |
| M4T14874 | 2-2089-MI | Mitsubishi | 86 | MBJ-4416 | 82-6884 | Prestolite | 122 |
| M4T95479A | 50-103-1 | Mitsubishi | 41 | MBJ-6002 | 82-6872-1 | Prestolite | 113 |
| M4T95479A | 50-103-2 | Mitsubishi | 40 | MBJ-6002A | 82-6872-1 | Prestolite | 113 |
| M5T50176 | 2-2092-MI | Mitsubishi | 89 | MBJ-6002S | 82-6872-1 | Prestolite | 113 |
| M5T50276 | 2-2091-MI | Mitsubishi | 89 | MBJ-6201 | 82-6868-1 | Prestolite | 121 |
| M7T03774 | 50-103-1 | Mitsubishi | 41 | MBJ-6201 | 82-6868-2 | Prestolite | 122 |
| M7T03774 | 50-103-2 | Mitsubishi | 40 | MBJ-6201 | 82-6868-3 | Prestolite | 122 |
| M8T50071 | 2-1748-MI-1 | Mitsubishi | 92 | MBJ-6201 | 82-6884 | Prestolite | 122 |
| M8T50071A | 2-1748-MI-1 | Mitsubishi | 92 | MCL-6225 | 82-6888 | Prestolite | 117 |
| M8T50072 | 2-1748-MI-1 | Mitsubishi | 92 | MCL-6225A | 82-6888 | Prestolite | 117 |
| M8T50171 | 2-1747-MI | Mitsubishi | 91 | MCL-6228 | 82-6888 | Prestolite | 117 |
| M8T50172 | 2-1747-MI | Mitsubishi | 91 | MCL-6508 | 82-6888 | Prestolite | 117 |
| M8T70071 | 2-2086-MI | Mitsubishi | 92 | MCL-6508S | 82-6888 | Prestolite | 117 |
| M9T82479 | 2-2824-MI | Mitsubishi | 92 | MCL-6509 | 82-6887 | Prestolite | 117 |
| MAY-4146 | 82-6888 | Prestolite | 117 | MCL-6509S | 82-6887 | Prestolite | 117 |
| MAY-4301 | 82-6888 | Prestolite | 117 | MD017649 | 2-1383-ND-2 | Mitsubishi Motors | 102 |
| MAY-4301S | 82-6888 | Prestolite | 117 | MD169683 | 1-2479-01MI | Mitsubishi Motors | 84 |
| MAY-4601 | 82-6888 | Prestolite | 117 | MD169683D | 1-2479-01MI | Mitsubishi Motors | 84 |
| MBJ-4003 | 82-6868-1 | Prestolite | 121 | MD171228 | 2-1612-MI | Mitsubishi Motors | 88 |
| MBJ-4003 | 82-6868-2 | Prestolite | 122 | MD171228 | 2-1612-MI-2 | Mitsubishi Motors | 88 |
| MBJ-4003 | 82-6868-3 | Prestolite | 122 | MD189054 | 2-1727-MI | Mitsubishi Motors | 85 |
| MBJ-4003 | 82-6884 | Prestolite | 122 | MD316418 | 1-2153-01MI | Mitsubishi Motors | 84 |
| MBJ-4007 | 82-6868-1 | Prestolite | 121 | MD318086 | 2-1996-MI | Mitsubishi Motors | 92 |
| MBJ-4007 | 82-6868-2 | Prestolite | 122 | MD320618 | 2-1996-MI | Mitsubishi Motors | 92 |
| MBJ-4007 | 82-6868-3 | Prestolite | 122 | MD354809 | 1-2153-01MI | Mitsubishi Motors | 84 |
| MBJ-4007 | 82-6884 | Prestolite | 122 | MD354809A | 1-2153-01MI | Mitsubishi Motors | 84 |
| MBJ-4008 | 82-6868-1 | Prestolite | 121 | MD354809D | 1-2153-01MI | Mitsubishi Motors | 84 |
| MBJ-4008 | 82-6868-2 | Prestolite | 122 | MDL-2256 | 82-6852 | Prestolite | 119 |
| MBJ-4008 | 82-6868-3 | Prestolite | 122 | MDL-2256 | 82-6852-1 | Prestolite | 119 |
| MBJ-4008 | 82-6884 | Prestolite | 122 | MDL-2256 | 82-6889 | Prestolite | 120 |
| MBJ-4201 | 82-6868-1 | Prestolite | 121 | MDY-6101 | 82-6861 | Prestolite | 114 |
| MBJ-4201 | 82-6868-2 | Prestolite | 122 | MDY-6102 | 82-6861 | Prestolite | 114 |
| MBJ-4201 | 82-6868-3 | Prestolite | 122 | MDY-6103 | 82-6862 | Prestolite | 115 |

CROSS REFERENCE - REF# to CATALOG#

| Mfr. Part No. | Catalog No. | Mfr. Name | Pg. # | Mfr. Part No. | Catalog No. | Mfr. Name | Pg. # |
|---------------|-------------|------------|-------|---------------|-------------|-------------------|-------|
| MDY-6109 | 82-6862 | Prestolite | 115 | MDY-7042A | 82-6855 | Prestolite | 113 |
| MDY-6115 | 82-6862 | Prestolite | 115 | MDY-7042A | 82-6871-1 | Prestolite | 116 |
| MDY-6116 | 82-6855 | Prestolite | 113 | MDY-7043 | 82-6861 | Prestolite | 114 |
| MDY-6116 | 82-6871-1 | Prestolite | 116 | MDY-7050 | 82-6861 | Prestolite | 114 |
| MDY-6116S | 82-6855 | Prestolite | 113 | MDY-7057 | 82-6861 | Prestolite | 114 |
| MDY-6116S | 82-6871-1 | Prestolite | 116 | MDY-7057A | 82-6861 | Prestolite | 114 |
| MDY-6118 | 82-6862 | Prestolite | 115 | MDY-7057S | 82-6861 | Prestolite | 114 |
| MDY-6119 | 82-6861 | Prestolite | 114 | MDY-7058 | 82-6870 | Prestolite | 116 |
| MDY-6119S | 82-6861 | Prestolite | 114 | MDY-7058S | 82-6870 | Prestolite | 116 |
| MDY-6121 | 82-6862 | Prestolite | 115 | MDY-7059 | 82-6861 | Prestolite | 114 |
| MDY-6121S | 82-6862 | Prestolite | 115 | MDY-7061 | 82-6855 | Prestolite | 113 |
| MDY-6122 | 82-6862 | Prestolite | 115 | MDY-7061 | 82-6871-1 | Prestolite | 116 |
| MDY-6124 | 82-6855 | Prestolite | 113 | MDY-7063 | 82-6855 | Prestolite | 113 |
| MDY-6124 | 82-6871-1 | Prestolite | 116 | MDY-7063 | 82-6871-1 | Prestolite | 116 |
| MDY-6124S | 82-6855 | Prestolite | 113 | MDY-7063S | 82-6855 | Prestolite | 113 |
| MDY-6124S | 82-6871-1 | Prestolite | 116 | MDY-7063S | 82-6871-1 | Prestolite | 116 |
| MDY-6125 | 82-6870 | Prestolite | 116 | MDY-7064 | 82-6862 | Prestolite | 115 |
| MDY-6125S | 82-6870 | Prestolite | 116 | MDY-7065 | 82-6862 | Prestolite | 115 |
| MDY-6126 | 82-6855 | Prestolite | 113 | MDY-7065S | 82-6862 | Prestolite | 115 |
| MDY-6126 | 82-6871-1 | Prestolite | 116 | MDY-7068 | 82-6861 | Prestolite | 114 |
| MDY-6126S | 82-6855 | Prestolite | 113 | MDY-7072 | 82-6855 | Prestolite | 113 |
| MDY-6126S | 82-6871-1 | Prestolite | 116 | MDY-7072 | 82-6871-1 | Prestolite | 116 |
| MDY-6128 | 82-6855 | Prestolite | 113 | MDY-7072S | 82-6855 | Prestolite | 113 |
| MDY-6128 | 82-6871-1 | Prestolite | 116 | MDY-7072S | 82-6871-1 | Prestolite | 116 |
| MDY-6128S | 82-6855 | Prestolite | 113 | MDY-7075 | 82-6861 | Prestolite | 114 |
| MDY-6128S | 82-6871-1 | Prestolite | 116 | ME001565 | 2-2228-MI | Mitsubishi Motors | 91 |
| MDY-6132 | 82-6861 | Prestolite | 114 | ME017035 | 2-2229-MI | Mitsubishi Motors | 91 |
| MDY-6132S | 82-6861 | Prestolite | 114 | ME017085 | 2-2229-MI | Mitsubishi Motors | 91 |
| MDY-6134 | 82-6862 | Prestolite | 115 | ME037465 | 2-1913-MI-1 | Mitsubishi Motors | 89 |
| MDY-6134S | 82-6861 | Prestolite | 114 | ME037636 | 2-1913-MI-1 | Mitsubishi Motors | 89 |
| MDY-6135 | 82-6855 | Prestolite | 113 | ME039950 | 2-2092-MI | Mitsubishi Motors | 89 |
| MDY-6135 | 82-6871-1 | Prestolite | 116 | ME049182 | 2-2092-MI | Mitsubishi Motors | 89 |
| MDY-6135S | 82-6855 | Prestolite | 113 | ME077407 | 2-1913-MI-1 | Mitsubishi Motors | 89 |
| MDY-6135S | 82-6871-1 | Prestolite | 116 | ME087506 | 2-2094-MI | Mitsubishi Motors | 90 |
| MDY-6143 | 82-6861 | Prestolite | 114 | ME087577 | 2-2094-MI | Mitsubishi Motors | 90 |
| MDY-6143S | 82-6861 | Prestolite | 114 | ME087676 | 2-2094-MI | Mitsubishi Motors | 90 |
| MDY-6157 | 82-6855 | Prestolite | 113 | MEA10-07 | 2-1738-MI-1 | Mitsubishi Motors | 86 |
| MDY-6157 | 82-6871-1 | Prestolite | 116 | MEA10-7 | 2-1738-MI-1 | Mitsubishi | 86 |
| MDY-6157S | 82-6855 | Prestolite | 113 | MEA13-1 | 2-1741-1 | Mitsubishi | 86 |
| MDY-6157S | 82-6871-1 | Prestolite | 116 | MEO17004 | 2-2220-MI | Mitsubishi | 90 |
| MDY-6202 | 82-6862 | Prestolite | 115 | MEY2R | 2-1741-1 | Mitsubishi | 86 |
| MDY-6202S | 82-6862 | Prestolite | 115 | MEY3R | 2-1741-1 | Mitsubishi | 86 |
| MDY-6203 | 82-6862 | Prestolite | 115 | MEZ-7002 | 82-6853 | Prestolite | 120 |
| MDY-6203S | 82-6862 | Prestolite | 115 | MFD-7009 | 82-6875 | Prestolite | 118 |
| MDY-6205 | 82-6862 | Prestolite | 115 | MFX-4001 | 82-6880 | Prestolite | 117 |
| MDY-6206 | 82-6862 | Prestolite | 115 | MFX-4001S | 82-6880 | Prestolite | 117 |
| MDY-6206S | 82-6862 | Prestolite | 115 | MFX-4002 | 82-6880 | Prestolite | 117 |
| MDY-7022 | 82-6855 | Prestolite | 113 | MFX-4002S | 82-6880 | Prestolite | 117 |
| MDY-7022 | 82-6871-1 | Prestolite | 116 | MFX-4003 | 82-6869 | Prestolite | 115 |
| MDY-7027 | 82-6861 | Prestolite | 114 | MFX-4003 | 82-6869-1 | Prestolite | 115 |
| MDY-7030 | 82-6870 | Prestolite | 116 | MFX-4003 | 82-6874 | Prestolite | 116 |
| MDY-7030S | 82-6870 | Prestolite | 116 | MFX-4003S | 82-6869 | Prestolite | 115 |
| MDY-7031 | 82-6855 | Prestolite | 113 | MFX-4003S | 82-6869-1 | Prestolite | 115 |
| MDY-7031 | 82-6871-1 | Prestolite | 116 | MFX-4003S | 82-6874 | Prestolite | 116 |
| MDY-7032 | 82-6855 | Prestolite | 113 | MGL-4005 | 82-7850 | Prestolite | 120 |
| MDY-7032 | 82-6871-1 | Prestolite | 116 | MGL-4105 | 82-7850 | Prestolite | 120 |
| MDY-7032A | 82-6855 | Prestolite | 113 | MHA-6001 | 82-6862 | Prestolite | 115 |
| MDY-7032A | 82-6871-1 | Prestolite | 116 | MHA-6001S | 82-6862 | Prestolite | 115 |
| MDY-7032B | 82-6855 | Prestolite | 113 | MHJ-2097 | 82-6876 | Prestolite | 118 |
| MDY-7032B | 82-6871-1 | Prestolite | 116 | MHN-4001 | 82-6860 | Prestolite | 114 |
| MDY-7037 | 82-6855 | Prestolite | 113 | MHN-4001 | 82-6860-1 | Prestolite | 114 |
| MDY-7037 | 82-6871-1 | Prestolite | 116 | MHN-4001 | 82-6860-2 | Prestolite | 114 |
| MDY-7037S | 82-6855 | Prestolite | 113 | MHN-4001 | 82-6860-3 | Prestolite | 114 |
| MDY-7037S | 82-6871-1 | Prestolite | 116 | MHN-4001A | 82-6860 | Prestolite | 114 |
| MDY-7039 | 82-6855 | Prestolite | 113 | MHN-4001A | 82-6860-1 | Prestolite | 114 |
| MDY-7039 | 82-6871-1 | Prestolite | 116 | MHN-4001A | 82-6860-2 | Prestolite | 114 |
| MDY-7039A | 82-6855 | Prestolite | 113 | MHN-4001A | 82-6860-3 | Prestolite | 114 |
| MDY-7039A | 82-6871-1 | Prestolite | 116 | MHN-4001B | 82-6860 | Prestolite | 114 |
| MDY-7039S | 82-6855 | Prestolite | 113 | MHN-4001B | 82-6860-1 | Prestolite | 114 |
| MDY-7039S | 82-6871-1 | Prestolite | 116 | MHN-4001B | 82-6860-2 | Prestolite | 114 |
| MDY-7042 | 82-6855 | Prestolite | 113 | MHN-4001B | 82-6860-3 | Prestolite | 114 |
| MDY-7042 | 82-6871-1 | Prestolite | 116 | MHN-4001S | 82-6860 | Prestolite | 114 |

CROSS REFERENCE

CROSS REFERENCE - REF# to CATALOG#

| Mfr. Part# | Catalog# | Mfr. Name | Pg. # | Mfr. Part# | Catalog# | Mfr. Name | Pg. # |
|------------|-------------|---------------------|-------|------------|-----------|---------------------|-------|
| MHN-4001S | 82-6860-1 | Prestolite | 114 | MMW-4002S | 82-6869-1 | Prestolite | 115 |
| MHN-4001S | 82-6860-2 | Prestolite | 114 | MMW-4002S | 82-6874 | Prestolite | 116 |
| MHN-4001S | 82-6860-3 | Prestolite | 114 | MMW-4004 | 82-6880 | Prestolite | 117 |
| MHN-4003 | 82-6860 | Prestolite | 114 | MMY-4001 | 82-6869 | Prestolite | 115 |
| MHN-4003 | 82-6860-1 | Prestolite | 114 | MMY-4001 | 82-6869-1 | Prestolite | 115 |
| MHN-4003 | 82-6860-2 | Prestolite | 114 | MMY-4001 | 82-6874 | Prestolite | 116 |
| MHN-4003 | 82-6860-3 | Prestolite | 114 | MMY-4001A | 82-6869 | Prestolite | 115 |
| MHN-4005 | 82-6860 | Prestolite | 114 | MMY-4001A | 82-6869-1 | Prestolite | 115 |
| MHN-4005 | 82-6860-1 | Prestolite | 114 | MMY-4001A | 82-6874 | Prestolite | 116 |
| MHN-4005 | 82-6860-2 | Prestolite | 114 | MMY-4001S | 82-6869 | Prestolite | 115 |
| MHN-4005 | 82-6860-3 | Prestolite | 114 | MMY-4001S | 82-6869-1 | Prestolite | 115 |
| MHN-4005A | 82-6860 | Prestolite | 114 | MMY-4001S | 82-6874 | Prestolite | 116 |
| MHN-4005A | 82-6860-1 | Prestolite | 114 | MMY-4002 | 82-6880 | Prestolite | 117 |
| MHN-4005A | 82-6860-2 | Prestolite | 114 | MMY-4002S | 82-6880 | Prestolite | 117 |
| MHN-4005A | 82-6860-3 | Prestolite | 114 | MMY-4004 | 82-6869 | Prestolite | 115 |
| MHN-7001 | 82-7861 | Prestolite | 118 | MMY-4004 | 82-6869-1 | Prestolite | 115 |
| MHP-4005 | 82-6876 | Prestolite | 118 | MMY-4004 | 82-6874 | Prestolite | 116 |
| MHP-4005S | 82-6876 | Prestolite | 118 | MMY-4004S | 82-6869 | Prestolite | 115 |
| MHP-4009 | 82-6876 | Prestolite | 118 | MMY-4004S | 82-6874 | Prestolite | 116 |
| MHP-4009S | 82-6876 | Prestolite | 118 | MMY-4402 | 82-6880 | Prestolite | 117 |
| MHT-6101 | 82-6890 | Prestolite | 122 | MMY-4402S | 82-6880 | Prestolite | 117 |
| MHT-6101S | 82-6890 | Prestolite | 122 | MMY-6101 | 82-6885 | Prestolite | 117 |
| MHT-7001 | 82-6890 | Prestolite | 122 | MMY-6101A | 82-6869 | Prestolite | 115 |
| MHT-7101 | 82-6890 | Prestolite | 122 | MMY-6101A | 82-6869-1 | Prestolite | 115 |
| MHT-7101S | 82-6890 | Prestolite | 122 | MMY-6101A | 82-6874 | Prestolite | 116 |
| MIB97059 | 2-2347-DR-1 | Mitsubishi | 38 | MMY-6101AS | 82-6869 | Prestolite | 115 |
| MIB97059 | 2-2352-DR-1 | Mitsubishi | 39 | MMY-6101AS | 82-6869-1 | Prestolite | 115 |
| MKW-4007 | 82-7850 | Prestolite | 120 | MMY-6101AS | 82-6874 | Prestolite | 116 |
| MKW-4009 | 82-6852 | Prestolite | 119 | MO551046A | 82-7850 | United Technologies | 120 |
| MKW-4009 | 82-6852-1 | Prestolite | 119 | MRV-B4 | 82-6867 | Prestolite | 121 |
| MKW-4009 | 82-6889 | Prestolite | 120 | MRV-B4 | 82-6867-1 | Prestolite | 121 |
| ML-4355 | 82-6879 | Prestolite | 117 | MRV-B5 | 82-6867 | Prestolite | 121 |
| ML-4357 | 82-6879 | Prestolite | 117 | MRV-B5 | 82-6867-1 | Prestolite | 121 |
| ML-4364 | 82-6879 | Prestolite | 117 | MRV-B7 | 82-6865 | Prestolite | 121 |
| ML-4368 | 82-6879 | Prestolite | 117 | MRV-B8 | 82-6868-1 | Prestolite | 121 |
| ML-4375 | 82-6879 | Prestolite | 117 | MRV-B8 | 82-6868-2 | Prestolite | 122 |
| ML-4502 | 82-6879 | Prestolite | 117 | MRV-B8 | 82-6868-3 | Prestolite | 122 |
| ML-4502A | 82-6879 | Prestolite | 117 | MRV-B8 | 82-6884 | Prestolite | 122 |
| ML-4509 | 82-6879 | Prestolite | 117 | MT67A | 2-2283-BO | Marelli | 4 |
| ML-4510 | 82-6879 | Prestolite | 117 | MT67AA | 2-2283-BO | Marelli | 4 |
| ML-4512 | 82-6879 | Prestolite | 117 | MT67AB | 2-2283-BO | Marelli | 4 |
| ML-5006 | 82-6879 | Prestolite | 117 | MT67AC | 2-2283-BO | Marelli | 4 |
| ML-5007 | 82-6879 | Prestolite | 117 | MT67AD | 2-2283-BO | Marelli | 4 |
| ML-5007S | 82-6879 | Prestolite | 117 | MT67BA | 2-2284-BO | Marelli | 4 |
| MM115514 | 2-1727-MI | Mitsubishi Motors | 85 | MT67CA | 50-9122-1 | Marelli | 7 |
| MM115517 | 2-1727-MI | Mitsubishi Motors | 85 | MT67CB | 50-9122-1 | Marelli | 7 |
| MM115518 | 2-1612-MI | Mitsubishi Motors | 88 | MT67DA | 2-2283-BO | Marelli | 4 |
| MM115518 | 2-1612-MI-2 | Mitsubishi Motors | 88 | MT67DB | 2-2283-BO | Marelli | 4 |
| MM115519 | 2-1612-MI-2 | Mitsubishi Motors | 88 | MT68AA | 50-9101-1 | Marelli | 6 |
| MM131020 | 1-2392-01MI | Mitsubishi Motors | 84 | MT68AB | 50-9101-1 | Marelli | 6 |
| MM18996 | 82-6852 | United Technologies | 119 | MT68AC | 50-9101-1 | Marelli | 6 |
| MM18996 | 82-6852-1 | United Technologies | 119 | MT68AD | 50-9101-1 | Marelli | 6 |
| MM18996 | 82-6889 | United Technologies | 120 | MT68LA | 50-9105-1 | Marelli | 6 |
| MM401600 | 2-2089-MI | Mitsubishi Motors | 86 | MT68LB | 50-9105-1 | Marelli | 6 |
| MM409413 | 2-1781-MI | Mitsubishi Motors | 88 | MT68LC | 50-9105-1 | Marelli | 6 |
| MM435751 | 1-2392-01MI | Mitsubishi Motors | 84 | MT71A | 2-2325-BO | Marelli | 5 |
| MM435752 | 1-2392-01MI | Mitsubishi Motors | 84 | MT71AA | 2-2325-BO | Marelli | 5 |
| MM48826 | 82-7850 | United Technologies | 120 | MT71AB | 2-2325-BO | Marelli | 5 |
| MMQ-4002 | 82-6864 | Prestolite | 115 | MT71Z | 50-9900 | Marelli | 49 |
| MMQ-4003 | 82-6864 | Prestolite | 115 | MUE-6001 | 82-6860 | Prestolite | 114 |
| MMQ-4003A | 82-6864 | Prestolite | 115 | MUE-6001 | 82-6860-1 | Prestolite | 114 |
| MMQ-4003AS | 82-6864 | Prestolite | 115 | MUE-6001 | 82-6860-2 | Prestolite | 114 |
| MMQ-4003S | 82-6864 | Prestolite | 115 | MUE-6001 | 82-6860-3 | Prestolite | 114 |
| MMQ-4004 | 82-6858 | Prestolite | 121 | MUE-6103 | 82-6852 | Prestolite | 119 |
| MMQ-4004S | 82-6858 | Prestolite | 121 | MUE-6103 | 82-6852-1 | Prestolite | 119 |
| MMW-4001 | 82-6869 | Prestolite | 115 | MUE-6103 | 82-6889 | Prestolite | 120 |
| MMW-4001 | 82-6869-1 | Prestolite | 115 | MUE-6103S | 82-6852 | Prestolite | 119 |
| MMW-4001 | 82-6874 | Prestolite | 116 | MUE-6103S | 82-6852-1 | Prestolite | 119 |
| MMW-4002 | 82-6869 | Prestolite | 115 | MUE-6103S | 82-6889 | Prestolite | 120 |
| MMW-4002 | 82-6869-1 | Prestolite | 115 | MUE-6104 | 82-6861 | Prestolite | 114 |
| MMW-4002 | 82-6874 | Prestolite | 116 | MUE-6104S | 82-6861 | Prestolite | 114 |
| MMW-4002 | 82-6874 | Prestolite | 116 | | | | |
| MMW-4002S | 82-6869 | Prestolite | 115 | | | | |

CROSS REFERENCE

CROSS REFERENCE - REF# to CATALOG#

| Mfr. Part No. | Catalog No. | Mfr. Name | Pg. # | Mfr. Part No. | Catalog No. | Mfr. Name | Pg. # |
|---------------|-------------|-------------|-------|---------------|--------------|--------------|-------|
| MUE-6106 | .82-6854 | .Prestolite | .113 | MUR-6202 | .82-6868-3 | .Prestolite | .122 |
| MUE-6106 | .82-6854-1 | .Prestolite | .113 | MUR-6202 | .82-6884 | .Prestolite | .122 |
| MUE-6107 | .82-6860 | .Prestolite | .114 | MUR-6202S | .82-6868-1 | .Prestolite | .121 |
| MUE-6107 | .82-6860-1 | .Prestolite | .114 | MUR-6202S | .82-6868-2 | .Prestolite | .122 |
| MUE-6107 | .82-6860-2 | .Prestolite | .114 | MUR-6202S | .82-6868-3 | .Prestolite | .122 |
| MUE-6107 | .82-6860-3 | .Prestolite | .114 | MUR-6202S | .82-6884 | .Prestolite | .122 |
| MUE-6107S | .82-6860 | .Prestolite | .114 | NAB901 | .1-2721-01LU | .Lucas | .77 |
| MUE-6107S | .82-6860-1 | .Prestolite | .114 | NAB903 | .1-2721-01LU | .Lucas | .77 |
| MUE-6107S | .82-6860-2 | .Prestolite | .114 | NSB503 | .2-2301-LU | .Lucas | .78 |
| MUE-6107S | .82-6860-3 | .Prestolite | .114 | OR5202 | .20-124-1 | .Caterpillar | .17 |
| MUE-6108 | .82-6873 | .Prestolite | .116 | OR5205 | .1-2301-00DR | .Caterpillar | .17 |
| MUE-6108S | .82-6873 | .Prestolite | .116 | OR5211 | .50-111 | .Caterpillar | .43 |
| MUE-6111 | .82-6852 | .Prestolite | .119 | OR5211 | .50-111-1 | .Caterpillar | .43 |
| MUE-6111 | .82-6852-1 | .Prestolite | .119 | OR5218 | .50-150-1 | .Caterpillar | .42 |
| MUE-6111 | .82-6889 | .Prestolite | .120 | OR5218 | .50-150-2 | .Caterpillar | .42 |
| MUE-61118 | .82-6852 | .Prestolite | .119 | P358 | .1-2454-01MM | .New Holland | .76 |
| MUE-61118 | .82-6852-1 | .Prestolite | .119 | PR5347 | .50-153-1 | .Caterpillar | .43 |
| MUE-61118 | .82-6889 | .Prestolite | .120 | PR5347 | .50-153-2 | .Caterpillar | .43 |
| MUE-6111S | .82-6852 | .Prestolite | .119 | PR5348 | .50-153-1 | .Caterpillar | .43 |
| MUE-6111S | .82-6852-1 | .Prestolite | .119 | PR5348 | .50-153-2 | .Caterpillar | .43 |
| MUE-6111S | .82-6889 | .Prestolite | .120 | R39341 | .2-1726-ND-2 | .Case | .102 |
| MUE-6113S | .82-6855 | .Prestolite | .113 | RE13722 | .2-2276-ND | .John Deere | .101 |
| MUE-6113S | .82-6871-1 | .Prestolite | .116 | RE13722 | .50-159-1 | .John Deere | .36 |
| MUE-6114S | .82-6885 | .Prestolite | .117 | RE15663 | .2-1962-ND | .John Deere | .100 |
| MUE-6114S | .82-7851 | .Prestolite | .118 | RE15718 | .2-2045-ND | .John Deere | .100 |
| MUE-6121 | .82-6862 | .Prestolite | .115 | RE19275 | .2-1750-ND | .John Deere | .103 |
| MUE-6201 | .82-6854 | .Prestolite | .113 | RE36246 | .1-2851-01ND | .John Deere | .100 |
| MUE-6201 | .82-6854-1 | .Prestolite | .113 | RE37201 | .1-2851-01ND | .John Deere | .100 |
| MUE-6201S | .82-6854 | .Prestolite | .113 | RE38336 | .2-2279-ND | .John Deere | .101 |
| MUE-6201S | .82-6854-1 | .Prestolite | .113 | RE42123 | .1-2851-01ND | .John Deere | .100 |
| MUE-6202 | .82-6859 | .Prestolite | .114 | RE43266 | .2-2279-ND | .John Deere | .101 |
| MUE-6202S | .82-6859 | .Prestolite | .114 | RE44140 | .1-2851-01ND | .John Deere | .100 |
| MUE-6206 | .82-6852 | .Prestolite | .119 | RE501294 | .2-2726-ND-2 | .John Deere | .110 |
| MUE-6206 | .82-6852-1 | .Prestolite | .119 | RE501298 | .2-2726-ND-2 | .John Deere | .110 |
| MUE-6206 | .82-6889 | .Prestolite | .120 | RE501693 | .2-2294-VA | .John Deere | .112 |
| MUE-6207 | .82-6888 | .Prestolite | .117 | RE502156 | .2-2294-VA | .John Deere | .112 |
| MUE-6207S | .82-6888 | .Prestolite | .117 | RE51447 | .2-1750-ND | .John Deere | .103 |
| MUE-6209 | .82-7852 | .Prestolite | .120 | RE51921 | .1-2851-01ND | .John Deere | .100 |
| MUE-6209S | .82-7852 | .Prestolite | .120 | RE54092 | .2-1750-ND | .John Deere | .103 |
| MUE-7001 | .82-6852 | .Prestolite | .119 | RE54416 | .2-2279-ND | .John Deere | .101 |
| MUE-7001 | .82-6852-1 | .Prestolite | .119 | RE54874 | .2-2043-ND | .John Deere | .100 |
| MUE-7001 | .82-6889 | .Prestolite | .120 | RE60641 | .2-2294-VA | .John Deere | .112 |
| MUE-7004 | .82-6854 | .Prestolite | .113 | RE68470 | .2-1750-ND | .John Deere | .103 |
| MUE-7004 | .82-6854-1 | .Prestolite | .113 | RE69704 | .2-2726-ND-2 | .John Deere | .110 |
| MUE-7004 | .82-6873 | .Prestolite | .116 | RE70957 | .2-2726-ND-2 | .John Deere | .110 |
| MUE-7005 | .82-6854 | .Prestolite | .113 | RE70975 | .2-2726-ND-2 | .John Deere | .110 |
| MUE-7005 | .82-6854-1 | .Prestolite | .113 | S114-150 | .2-1724-HI-1 | .Hitachi | .68 |
| MUE-7005 | .82-6873 | .Prestolite | .116 | S114-151 | .2-1724-HI-1 | .Hitachi | .68 |
| MUE-7005S | .82-6854 | .Prestolite | .113 | S114-151L | .2-1724-HI-1 | .Hitachi | .68 |
| MUE-7005S | .82-6854-1 | .Prestolite | .113 | S114-164 | .2-1724-HI-1 | .Hitachi | .68 |
| MUE-7005S | .82-6873 | .Prestolite | .116 | S114-164A | .2-1724-HI-1 | .Hitachi | .68 |
| MUE-7006 | .82-6854 | .Prestolite | .113 | S114-184 | .2-1736-HI-1 | .Hitachi | .68 |
| MUE-7006 | .82-6854-1 | .Prestolite | .113 | S114-198 | .2-1736-HI-1 | .Hitachi | .68 |
| MUE-7006 | .82-6873 | .Prestolite | .116 | S114-381 | .2-2007-HI | .Hitachi | .69 |
| MUE-7006S | .82-6873 | .Prestolite | .116 | S114-385 | .2-1855-HI | .Hitachi | .69 |
| MUF-6102 | .82-6875 | .Prestolite | .118 | S114-429 | .2-2311-HI | .Hitachi | .72 |
| MUF-6102S | .82-6875 | .Prestolite | .118 | S114-429A | .2-2311-HI | .Hitachi | .72 |
| MUF-6104 | .82-6875 | .Prestolite | .118 | S114-449 | .2-2311-HI | .Hitachi | .72 |
| MUF-6104S | .82-6875 | .Prestolite | .118 | S114-449A | .2-2311-HI | .Hitachi | .72 |
| MUF-7001 | .82-6875 | .Prestolite | .118 | S114-482 | .2-2012-HI | .Hitachi | .70 |
| MUF-7002 | .82-6875 | .Prestolite | .118 | S114-482A | .2-2012-HI | .Hitachi | .70 |
| MUF-7002S | .82-6875 | .Prestolite | .118 | S114-71 | .2-1741-1 | .Hitachi | .86 |
| MUP-6201 | .82-6860 | .Prestolite | .114 | S114-91 | .2-1741-1 | .Hitachi | .86 |
| MUP-6201 | .82-6860-1 | .Prestolite | .114 | S114-91K | .2-1741-1 | .Hitachi | .86 |
| MUP-6201 | .82-6860-2 | .Prestolite | .114 | S12-41A | .2-1734-HI | .Hitachi | .70 |
| MUP-6201 | .82-6860-3 | .Prestolite | .114 | S12-59 | .2-1734-HI | .Hitachi | .70 |
| MUP-6201S | .82-6860 | .Prestolite | .114 | S12-62 | .2-2317-HI | .Hitachi | .69 |
| MUP-6201S | .82-6860-1 | .Prestolite | .114 | S12-84 | .2-2301-LU | .Hitachi | .78 |
| MUP-6201S | .82-6860-2 | .Prestolite | .114 | S13-104 | .2-2014-HI | .Hitachi | .70 |
| MUP-6201S | .82-6860-3 | .Prestolite | .114 | S13-106A | .2-2235-HI | .Hitachi | .71 |
| MUR-6202 | .82-6868-1 | .Prestolite | .121 | S13-106B | .2-2235-HI | .Hitachi | .71 |
| MUR-6202 | .82-6868-2 | .Prestolite | .122 | S13-111 | .2-2006-HI | .Hitachi | .70 |

CROSS REFERENCE

CROSS REFERENCE - REF# to CATALOG#

| Mfr. Part# | Catalog# | Mfr. Name | Pg. # | Mfr. Part# | Catalog# | Mfr. Name | Pg. # |
|--------------|-------------|------------|-------|------------|-------------|------------|-------|
| S13-136 | 2-2006-HI | Hitachi | 70 | SA-739 | 50-157-9 | Motorcraft | 28 |
| S13-204 | 2-2758-HI-2 | Hitachi | 73 | SA-746 | 2-1649-FD | Motorcraft | 60 |
| S13-207A | 2-2318-HI | Hitachi | 72 | SA-756 | 50-153-1 | Motorcraft | 43 |
| S13-207C | 2-2318-HI | Hitachi | 72 | SA-756 | 50-153-2 | Motorcraft | 43 |
| S13-211 | 2-1776-HI | Hitachi | 70 | SA-756-A | 50-153-1 | Motorcraft | 43 |
| S13-289 | 2-1776-HI | Hitachi | 70 | SA-756-A | 50-153-2 | Motorcraft | 43 |
| S13-289A | 2-1776-HI | Hitachi | 70 | SA-757 | 50-100-1 | Motorcraft | 40 |
| S13-61 | 2-2026-HI | Hitachi | 69 | SA-757 | 50-100-2 | Motorcraft | 40 |
| S13-61A | 2-2026-HI | Hitachi | 69 | SA-764-A | 50-193-1 | Motorcraft | 36 |
| S13-73 | 2-2737-HI-2 | Hitachi | 69 | SA-768-A | 2-2471-DR | Motorcraft | 41 |
| S13-82 | 2-1193-HI | Hitachi | 69 | SA-769 | 2-1806-FD-1 | Motorcraft | 62 |
| S13-82A | 2-1193-HI | Hitachi | 69 | SA-769-A | 2-1806-FD-1 | Motorcraft | 62 |
| S13-82B | 2-1193-HI | Hitachi | 69 | SA-775 | 50-220-1 | Motorcraft | 64 |
| S13-84 | 2-1734-HI | Hitachi | 70 | SA-776 | 2-1885-FD-1 | Motorcraft | 62 |
| S13-84A | 2-1734-HI | Hitachi | 70 | SA-778 | 50-153-1 | Motorcraft | 43 |
| S13-84B | 2-1734-HI | Hitachi | 70 | SA-778 | 50-153-2 | Motorcraft | 43 |
| S13-89 | 2-1776-HI | Hitachi | 70 | SA-785 | 2-1894-FD-1 | Motorcraft | 63 |
| S13-89A | 2-1776-HI | Hitachi | 70 | SA-789 | 2-1799-FD-1 | Motorcraft | 62 |
| S13-89B | 2-1776-HI | Hitachi | 70 | SA-793 | 2-1881-FD-1 | Motorcraft | 62 |
| S13-89C | 2-1776-HI | Hitachi | 70 | SA-794 | 2-1883-FD-1 | Motorcraft | 62 |
| S13-92A | 2-2014-HI | Hitachi | 70 | SA-795 | 2-1882-FD-1 | Motorcraft | 62 |
| S14-02 | 2-2319-HI | Hitachi | 72 | SA-796 | 2-2675-DR | Motorcraft | 42 |
| S14-100D | 2-2320-HI-1 | Hitachi | 72 | SA-797 | 2-1953-FD-1 | Motorcraft | 63 |
| S14-100E | 2-2320-HI-1 | Hitachi | 72 | SA-798 | 2-1956-FD-1 | Motorcraft | 64 |
| S14-101A | 2-2320-HI-1 | Hitachi | 72 | SA-802 | 50-8428 | Motorcraft | 32 |
| S14-101B | 2-2320-HI-1 | Hitachi | 72 | SA-803 | 50-8425 | Motorcraft | 32 |
| S14-20 | 2-2319-HI | Hitachi | 72 | SA-808 | 2-1799-FD-1 | Motorcraft | 62 |
| S24-01B | 2-2101-HI-2 | Hitachi | 71 | SA-809 | 50-161-1 | Motorcraft | 36 |
| S24-01C | 2-2101-HI-2 | Hitachi | 71 | SA-817 | 2-1748-MI-1 | Motorcraft | 92 |
| S24-01D | 2-2101-HI-2 | Hitachi | 71 | SA-822 | 2-1799-FD-1 | Motorcraft | 62 |
| S24-03C | 2-2230-HI | Hitachi | 71 | SA-823 | 50-153-1 | Motorcraft | 43 |
| S24-07 | 2-2100-HI | Hitachi | 71 | SA-823 | 50-153-2 | Motorcraft | 43 |
| S25-110A | 2-2037-HI | Hitachi | 70 | SA-824 | 2-2471-DR | Motorcraft | 41 |
| S25-110C | 2-2037-HI | Hitachi | 70 | SA-827 | 50-152-1 | Motorcraft | 42 |
| S25-110G | 2-2037-HI | Hitachi | 70 | SA-827 | 50-152-2 | Motorcraft | 42 |
| S25-120 | 2-2231-HI | Hitachi | 71 | SA-828 | 2-2471-DR | Motorcraft | 41 |
| S25-120A | 2-2231-HI | Hitachi | 71 | SA-829 | 50-153-1 | Motorcraft | 43 |
| S25-121 | 2-2264-HI | Hitachi | 72 | SA-829 | 50-153-2 | Motorcraft | 43 |
| S25-121A | 2-2264-HI | Hitachi | 72 | SA-835 | 50-192-1 | Motorcraft | 43 |
| S25-125 | 2-2101-HI-2 | Hitachi | 71 | SA-835 | 50-192-2 | Motorcraft | 43 |
| S25-125A | 2-2101-HI-2 | Hitachi | 71 | SA-836 | 50-237-1 | Motorcraft | 64 |
| S25-125B | 2-2101-HI-2 | Hitachi | 71 | SA-838 | 2-1799-FD-1 | Motorcraft | 62 |
| S25-158 | 2-2321-HI | Hitachi | 72 | SA-841 | 2-1806-FD-1 | Motorcraft | 62 |
| S25-158A | 2-2321-HI | Hitachi | 72 | SA-842 | 2-1799-FD-1 | Motorcraft | 62 |
| S25-158B | 2-2321-HI | Hitachi | 72 | SA-843 | 2-2051-DR | Motorcraft | 29 |
| S25-163 | 2-2233-HI | Hitachi | 71 | SA-845 | 50-192-1 | Motorcraft | 43 |
| S25-163A | 2-2233-HI | Hitachi | 71 | SA-845 | 50-192-2 | Motorcraft | 43 |
| S25-163B | 2-2233-HI | Hitachi | 71 | SA-848 | 2-1799-FD-1 | Motorcraft | 62 |
| S25-163C | 2-2233-HI | Hitachi | 71 | SA-849 | 2-1799-FD-1 | Motorcraft | 62 |
| S25-163E | 2-2233-HI | Hitachi | 71 | SA-850 | 2-1881-FD-1 | Motorcraft | 62 |
| S25-164A | 2-2037-HI | Hitachi | 70 | SA-852 | 2-1883-FD-1 | Motorcraft | 62 |
| S25-64 | 2-2037-HI | Hitachi | 70 | SA-853 | 2-1885-FD-1 | Motorcraft | 62 |
| S25-64B | 2-2037-HI | Hitachi | 70 | SA-854 | 2-1953-FD-1 | Motorcraft | 63 |
| S25-64E | 2-2037-HI | Hitachi | 70 | SA-855 | 2-1956-FD-1 | Motorcraft | 64 |
| S25-64F | 2-2037-HI | Hitachi | 70 | SA-856 | 2-1882-FD-1 | Motorcraft | 62 |
| S5SN-18-300 | 1-1960-01MI | Mazda | 84 | SA-857 | 2-1894-FD-1 | Motorcraft | 63 |
| S5SN-18-300A | 1-1960-01MI | Mazda | 84 | SA-858 | 2-1895-FD-1 | Motorcraft | 63 |
| SA-625 | 2-1674-FD | Motorcraft | 60 | SA-859 | 2-1887-FD-1 | Motorcraft | 63 |
| SA-628 | 2-1674-FD | Motorcraft | 60 | SA-860 | 2-1886-FD-1 | Motorcraft | 63 |
| SA-660 | 2-1668-FD | Motorcraft | 60 | SA-873 | 2-1910-FD-1 | Motorcraft | 63 |
| SA-660-A | 2-1668-FD | Motorcraft | 60 | SA-875 | 2-1955-FD-1 | Motorcraft | 64 |
| SA-701-A | 2-1675-FD | Motorcraft | 61 | SA-891 | 50-237-1 | Motorcraft | 64 |
| SA-706 | 2-1674-FD | Motorcraft | 60 | SA-897 | 2-2218-FD | Motorcraft | 64 |
| SA-709 | 2-1668-FD | Motorcraft | 60 | SA-900 | 2-2197-FD-2 | Motorcraft | 61 |
| SA-710 | 2-1674-FD | Motorcraft | 60 | SA-902 | 2-2197-FD-2 | Motorcraft | 61 |
| SA-713 | 2-1674-FD | Motorcraft | 60 | SA-903 | 2-2197-FD-2 | Motorcraft | 61 |
| SA-717 | 2-1675-FD | Motorcraft | 61 | SA-904 | 2-2215-FD | Motorcraft | 61 |
| SA-734 | 2-1648-FD | Motorcraft | 60 | SA-911 | 2-1806-FD-1 | Motorcraft | 62 |
| SA-734-B | 2-1648-FD | Motorcraft | 60 | SA-912 | 2-1799-FD-1 | Motorcraft | 62 |
| SA-737 | 2-1648-FD | Motorcraft | 60 | SA-921 | 2-1887-FD-1 | Motorcraft | 63 |
| SA-738 | 2-1642-FD | Motorcraft | 60 | SA-930 | 2-1886-FD-1 | Motorcraft | 63 |
| SA-738-A | 2-1642-FD | Motorcraft | 60 | SAE-739-A | 2-1254-MI-2 | Motorcraft | 87 |

CROSS REFERENCE

CROSS REFERENCE - REF# to CATALOG#

| Mfr. Part No. | Catalog No. | Mfr. Name | Pg. # | Mfr. Part No. | Catalog No. | Mfr. Name | Pg. # |
|----------------|----------------|----------------|-------|---------------|-------------|-----------|-------|
| SAE-739-B | .2-1254-MI-2 | .Motorcraft | .87 | | | | |
| SAE-819 | .2-1747-MI | .Motorcraft | .91 | | | | |
| SBA-18508-6410 | .2-1780-MI | .Ford | .88 | | | | |
| SBA-18508-6500 | .2-1780-MI | .Ford | .88 | | | | |
| SBA-18508-6550 | .2-2569-MI | .Ford | .93 | | | | |
| SBA-18508-6551 | .2-2569-MI | .Ford | .93 | | | | |
| SG10S039 | .1-2602-01VA | .Valeo | .112 | | | | |
| SG10S049 | .1-2602-01VA | .Valeo | .112 | | | | |
| SG10S051 | .1-2602-01VA | .Valeo | .112 | | | | |
| SG10S051SP | .1-2602-01VA | .Valeo | .112 | | | | |
| SG12B087 | .1-2768-01BO | .Valeo | .3 | | | | |
| SLR4-18-300 | .1-2438-01MI | .Mazda | .84 | | | | |
| TA000A48401 | .1-2466-01MD | .Valeo | .82 | | | | |
| TA000A48402 | .1-2466-01MD | .Valeo | .82 | | | | |
| TA000B32301 | .1-2467-01MD | .Valeo | .82 | | | | |
| TG15S096 | .1-2510-01VA | .Valeo | .112 | | | | |
| TM000A21901 | .2-1554-MI | .Valeo | .85 | | | | |
| TM000A21901 | .2-1554-MI-1 | .Valeo | .85 | | | | |
| TM000A28901 | .2-2306-MD | .Valeo | .83 | | | | |
| TM000A29001 | .2-2307-MD | .Valeo | .83 | | | | |
| TM000A32601 | .2-2308-MD | .Valeo | .83 | | | | |
| TY24438 | .2-1750-ND | .John Deere | .103 | | | | |
| TY24439 | .2-2726-ND-2 | .John Deere | .110 | | | | |
| TY6612 | .2-2277-ND | .John Deere | .101 | | | | |
| TY6613 | .2-2044-ND | .John Deere | .100 | | | | |
| TY6617 | .2-2276-ND | .John Deere | .101 | | | | |
| TY6617 | .50-159-1 | .John Deere | .36 | | | | |
| TY6621 | .1-2236-10ND | .John Deere | .97 | | | | |
| TY6647 | .1-2461-01ND | .John Deere | .94 | | | | |
| TY6648 | .2-2705-ND-2 | .John Deere | .109 | | | | |
| TY6654 | .2-1962-ND | .John Deere | .100 | | | | |
| TY6673 | .2-2705-ND-2 | .John Deere | .109 | | | | |
| TY6684 | .1-2851-01ND | .John Deere | .100 | | | | |
| TY6688 | .2-1750-ND | .John Deere | .103 | | | | |
| TY6712 | .2-2044-ND | .John Deere | .100 | | | | |
| TY6713 | .2-2276-ND | .John Deere | .101 | | | | |
| TY6713 | .50-159-1 | .John Deere | .36 | | | | |
| TY6718 | .2-2045-ND | .John Deere | .100 | | | | |
| TY6719 | .2-1750-ND | .John Deere | .103 | | | | |
| TY6750 | .1-2344-00BO | .John Deere | .2 | | | | |
| TY6752 | .1-2720-11DR-2 | .John Deere | .10 | | | | |
| TY6778 | .1-2435-01BO | .John Deere | .73 | | | | |
| TY6792 | .1-2435-01BO | .John Deere | .73 | | | | |
| W4BD0355 | .82-6877 | .Haldex-Barnes | .118 | | | | |
| W4BD2273 | .82-6878 | .Haldex-Barnes | .119 | | | | |
| XC3U-10300-DB | .1-1997-11FD-2 | .Ford | .52 | | | | |
| XC3U-10300-DC | .1-1997-11FD-2 | .Ford | .52 | | | | |
| XL1U-11000-AA | .2-1955-FD-1 | .Ford | .64 | | | | |
| XL1U-11000-AB | .2-1955-FD-1 | .Ford | .64 | | | | |
| XL1U-11000-AC | .2-1955-FD-1 | .Ford | .64 | | | | |
| XL1Z-11002-AA | .2-1955-FD-1 | .Ford | .64 | | | | |
| XL3U-10300-BA | .20-239-31-2 | .Ford | .56 | | | | |
| XL3U-10300-BB | .20-239-31-2 | .Ford | .56 | | | | |
| YC3U-11000-AA | .2-1910-FD-1 | .Ford | .63 | | | | |
| ZZL0-18-300 | .20-221-11-2 | .Mazda | .52 | | | | |
| ZZL0-18-301 | .20-221-10-2 | .Mazda | .52 | | | | |
| ZZL0-18-400 | .50-220-1 | .Mazda | .64 | | | | |
| ZZL1-18-400 | .2-1885-FD-1 | .Mazda | .62 | | | | |
| ZZM0-18-300 | .20-221-10-2 | .Mazda | .52 | | | | |
| ZZM0-18-400 | .2-1894-FD-1 | .Mazda | .63 | | | | |
| ZZM2-18-300 | .20-228-10-2 | .Mazda | .54 | | | | |
| ZZP0-18-400 | .2-1887-FD-1 | .Mazda | .63 | | | | |
| ZZP0-18-400A | .2-1887-FD-1 | .Mazda | .63 | | | | |
| ZZP1-18-400 | .2-1894-FD-1 | .Mazda | .63 | | | | |
| ZZP2-18-400 | .2-1886-FD-1 | .Mazda | .63 | | | | |
| ZZP2-18-400A | .2-1886-FD-1 | .Mazda | .63 | | | | |
| ZZP5-18-400 | .2-1895-FD-1 | .Mazda | .63 | | | | |
| ZZP5-18-400A | .2-1895-FD-1 | .Mazda | .63 | | | | |

CROSS REFERENCE

NUMERICAL INDEX - CATALOG# to PAGE#

| Catalog# | Page | Catalog# | Page | Catalog# | Page | Catalog# | Page |
|---------------|------|---------------|------|---------------|------|-------------|------|
| 1-1111-02HI | 64 | 1-2334-00DR | 14 | 1-2621-01LU-2 | 76 | 2-1733-MI | 88 |
| 1-1112-01 | 65 | 1-2334-00DR-3 | 14 | 1-2652-00LN | 74 | 2-1734-HI | 70 |
| 1-1503-01ND-2 | 95 | 1-2336-01ND | 98 | 1-2653-00LN | 74 | 2-1736-HI-1 | 68 |
| 1-1503-05ND-2 | 95 | 1-2336-01ND-9 | 98 | 1-2655-00LN | 74 | 2-1737-ND | 103 |
| 1-1503-06ND-2 | 95 | 1-2344-00BO | 2 | 1-2658-00LN | 74 | 2-1738-MI-1 | 86 |
| 1-1504-01ND-2 | 95 | 1-2350-11FD-2 | 58 | 1-2661-00LN | 75 | 2-1740-MI | 86 |
| 1-1504-05ND-2 | 95 | 1-2358-01HI | 66 | 1-2662-00DR | 16 | 2-1741-1 | 86 |
| 1-1504-06ND-2 | 96 | 1-2389-01ND-2 | 97 | 1-2663-00DR | 16 | 2-1745-ND-1 | 103 |
| 1-1527-02ND-2 | 96 | 1-2390-01ND | 97 | 1-2665-00LN | 76 | 2-1747-MI | 91 |
| 1-1612-33FD-2 | 52 | 1-2391-01MI | 83 | 1-2667-31FD | 59 | 2-1748-MI-1 | 92 |
| 1-1802-21DR-1 | 25 | 1-2392-01MI | 84 | 1-2669-31FD | 59 | 2-1750-ND | 103 |
| 1-1802-31DR-1 | 26 | 1-2398-11DR | 27 | 1-2678-00DR | 19 | 2-1751-ND-2 | 103 |
| 1-1802-42DR-1 | 26 | 1-2410-11DR | 9 | 1-2680-00DR | 20 | 2-1753-ND | 103 |
| 1-1806-12FD | 49 | 1-2410-11DR-1 | 9 | 1-2682-00DR | 21 | 2-1754-ND | 103 |
| 1-1915-00DR | 11 | 1-2415-41DR | 22 | 1-2685-00BO | 3 | 2-1776-HI | 70 |
| 1-1916-00DR | 12 | 1-2418-41DR | 22 | 1-2711-00BO | 2 | 2-1780-MI | 88 |
| 1-1917-00DR | 12 | 1-2419-21DR | 22 | 1-2711-01BO | 2 | 2-1781-MI | 88 |
| 1-1918-00DR | 12 | 1-2427-30DR | 11 | 1-2720-11DR-2 | 10 | 2-1796-DR | 47 |
| 1-1929-01MI | 83 | 1-2428-00DR-3 | 15 | 1-2721-01LU | 77 | 2-1799-FD-1 | 62 |
| 1-1940-01HI | 65 | 1-2429-00MO | 75 | 1-2730-00LU | 77 | 2-1803-BO-2 | 4 |
| 1-1946-01ND | 97 | 1-2431-00DR-3 | 15 | 1-2741-01VA | 112 | 2-1806-FD-1 | 62 |
| 1-1960-01MI | 84 | 1-2434-01MI | 83 | 1-2754-02LU | 77 | 2-1807-ND-2 | 104 |
| 1-1995-21DR-1 | 26 | 1-2435-01BO | 73 | 1-2762-01LU | 77 | 2-1811-DR-2 | 46 |
| 1-1995-22DR | 26 | 1-2436-01ND | 98 | 1-2768-01BO | 3 | 2-1822-ND | 104 |
| 1-1997-11FD-2 | 52 | 1-2438-01MI | 84 | 1-2821-01ND-2 | 99 | 2-1855-HI | 69 |
| 1-2037-21DR | 27 | 1-2439-01ND | 98 | 1-2822-01ND-2 | 99 | 2-1881-FD-1 | 62 |
| 1-2042-21DR-1 | 26 | 1-2441-01ND | 97 | 1-2823-01ND-2 | 100 | 2-1882-FD-1 | 62 |
| 1-2044-00DR | 14 | 1-2454-01MM | 76 | 1-2836-11MO-2 | 75 | 2-1883-FD-1 | 62 |
| 1-2045-01BO-2 | 2 | 1-2455-01MM | 73 | 1-2840-01ND-2 | 95 | 2-1885-FD-1 | 62 |
| 1-2057-00DR-1 | 19 | 1-2456-01ND | 99 | 1-2851-01ND | 100 | 2-1886-FD-1 | 63 |
| 1-2060-00DR-1 | 20 | 1-2457-01LU | 76 | 1-2852-01BO | 3 | 2-1887-FD-1 | 63 |
| 1-2062-01MI | 84 | 1-2461-01ND | 94 | 1-2877-01BO | 1 | 2-1894-FD-1 | 63 |
| 1-2065-00DR | 15 | 1-2462-31MD | 82 | 1-2878-01BO | 3 | 2-1895-FD-1 | 63 |
| 1-2065-00DR-3 | 15 | 1-2466-01MD | 82 | 1-2928-01DR | 28 | 2-1910-FD-1 | 63 |
| 1-2077-00DR-1 | 19 | 1-2467-01MD | 82 | 2-1193-HI | 69 | 2-1912-DR-2 | 46 |
| 1-2078-00DR-1 | 20 | 1-2469-01HI | 68 | 2-1193-ND | 101 | 2-1913-MI-1 | 89 |
| 1-2087-01ND-2 | 96 | 1-2470-01HI | 66 | 2-1254-MI-2 | 87 | 2-1946-BO | 7 |
| 1-2119-11ND | 98 | 1-2471-01HI | 67 | 2-1383-ND-2 | 102 | 2-1951-NK-1 | 93 |
| 1-2119-11ND-9 | 98 | 1-2472-01HI | 67 | 2-1397-ND-1 | 102 | 2-1953-FD-1 | 63 |
| 1-2132-01ND | 98 | 1-2473-01HI | 67 | 2-1398-ND-2 | 102 | 2-1954-DR-2 | 44 |
| 1-2132-01ND-2 | 98 | 1-2474-01HI | 67 | 2-1413-DR | 47 | 2-1955-FD-1 | 64 |
| 1-2153-01MI | 84 | 1-2475-01HI | 65 | 2-1444-MI | 92 | 2-1956-FD-1 | 64 |
| 1-2154-00DR | 15 | 1-2476-01ND | 99 | 2-1444-MI-9 | 92 | 2-1960-ND | 104 |
| 1-2156-21DR-1 | 26 | 1-2477-01ND | 99 | 2-1470-DR | 47 | 2-1960-ND-2 | 104 |
| 1-2172-31FD-2 | 57 | 1-2478-01ND | 99 | 2-1474-DR-2 | 46 | 2-1962-ND | 100 |
| 1-2173-11FD-2 | 57 | 1-2479-01MI | 84 | 2-1493-DR | 47 | 2-1963-MI | 89 |
| 1-2175-31DR-1 | 27 | 1-2480-01MI | 85 | 2-1526-ND | 102 | 2-1981-ND-2 | 104 |
| 1-2178-31FD-2 | 57 | 1-2481-01HI | 67 | 2-1554-MI | 85 | 2-1983-ND | 104 |
| 1-2197-21DR | 21 | 1-2482-01HI | 67 | 2-1554-MI-1 | 85 | 2-1996-MI | 92 |
| 1-2209-11FD-2 | 58 | 1-2488-01DR | 9 | 2-1580-DR | 29 | 2-2001-DR | 37 |
| 1-2225-01BO | 1 | 1-2489-01DR | 9 | 2-1582-DR-1 | 34 | 2-2006-HI | 70 |
| 1-2225-01ND-2 | 96 | 1-2495-01HI | 68 | 2-1584-DR-2 | 34 | 2-2007-HI | 69 |
| 1-2227-01ND | 96 | 1-2496-01HI | 68 | 2-1592-DR | 47 | 2-2012-HI | 70 |
| 1-2227-02BO | 1 | 1-2504-31FD | 58 | 2-1593-DR | 48 | 2-2014-HI | 70 |
| 1-2227-02ND-2 | 97 | 1-2510-01BO | 2 | 2-1595-DR | 48 | 2-2024-MI | 89 |
| 1-2236-10ND | 97 | 1-2510-01VA | 112 | 2-1598-DR-2 | 48 | 2-2026-HI | 69 |
| 1-2237-00BO | 2 | 1-2511-11FD-2 | 58 | 2-1601-DR-2 | 48 | 2-2037-HI | 70 |
| 1-2270-31FD-2 | 58 | 1-2512-31FD-2 | 59 | 2-1604-DR | 48 | 2-2043-ND | 100 |
| 1-2271-01HI | 65 | 1-2526-01BO-2 | 1 | 2-1607-DR | 48 | 2-2044-ND | 100 |
| 1-2280-00DR | 15 | 1-2531-11FD | 59 | 2-1612-MI | 88 | 2-2045-ND | 100 |
| 1-2291-00DR | 12 | 1-2532-00MO | 75 | 2-1612-MI-2 | 88 | 2-2051-DR | 29 |
| 1-2292-00DR | 12 | 1-2539-31FD | 59 | 2-1642-FD | 60 | 2-2054-DR-2 | 44 |
| 1-2297-00DR | 13 | 1-2541-01BO | 1 | 2-1648-FD | 60 | 2-2072-ND | 104 |
| 1-2299-00DR | 13 | 1-2547-00BO | 2 | 2-1649-FD | 60 | 2-2086-MI | 92 |
| 1-2300-00DR | 14 | 1-2553-01BO | 1 | 2-1668-FD | 60 | 2-2087-MI | 89 |
| 1-2301-00DR | 17 | 1-2556-21DR | 28 | 2-1674-FD | 60 | 2-2087-MI-1 | 89 |
| 1-2304-00DR-1 | 20 | 1-2558-00DR-1 | 19 | 2-1675-FD | 61 | 2-2088-MI | 86 |
| 1-2308-31MD | 82 | 1-2561-00DR | 20 | 2-1682-ND | 100 | 2-2089-MI | 86 |
| 1-2312-01HI | 65 | 1-2562-00DR | 21 | 2-1690-DR-2 | 46 | 2-2091-MI | 89 |
| 1-2313-01HI | 66 | 1-2563-00DR | 21 | 2-1717-ND | 102 | 2-2092-MI | 89 |
| 1-2314-01HI | 66 | 1-2564-00LN | 75 | 2-1724-HI-1 | 68 | 2-2093-MI | 90 |
| 1-2315-01 | 68 | 1-2570-00DR | 16 | 2-1726-ND-2 | 102 | 2-2094-MI | 90 |
| 1-2316-01HI | 65 | 1-2571-00DR | 16 | 2-1727-MI | 85 | 2-2095-DR-2 | 46 |
| 1-2317-01HI | 66 | 1-2589-01BO | 3 | 2-1728-MI | 85 | 2-2099-ND | 105 |
| 1-2320-21DR | 21 | 1-2602-01VA | 112 | 2-1728-MI-3 | 92 | 2-2100-HI | 71 |
| 1-2332-01HI | 66 | 1-2614-01VA | 112 | 2-1729-MI | 85 | 2-2101-HI-2 | 71 |
| 1-2333-00DR | 14 | 1-2619-01LU | 76 | 2-1732-MI-1 | 88 | 2-2101-MI | 90 |

NUMERICAL INDEX - CATALOG# to PAGE#

| Catalog# | Page | Catalog# | Page | Catalog# | Page | Catalog# | Page |
|-------------|------|-------------|------|-------------|------|--------------|------|
| 2-2102-MI | 90 | 2-2317-HI | 69 | 2-2731-NK-2 | 94 | 20-228-14-2 | 55 |
| 2-2103-MI | 90 | 2-2318-HI | 72 | 2-2732-ND-2 | 110 | 20-229-10-2 | 55 |
| 2-2104-ND | 105 | 2-2319-HI | 72 | 2-2733-ND-2 | 110 | 20-229-11-2 | 55 |
| 2-2105-ND | 105 | 2-2320-HI-1 | 72 | 2-2734-ND-2 | 110 | 20-229-12-2 | 55 |
| 2-2106-ND | 105 | 2-2321-HI | 72 | 2-2735-ND-2 | 111 | 20-229-14-2 | 55 |
| 2-2107-ND | 105 | 2-2325-BO | 5 | 2-2736-BO-2 | 8 | 20-229-31-2 | 55 |
| 2-2108-ND | 106 | 2-2327-ND | 108 | 2-2737-HI-2 | 8 | 20-232-10-2 | 56 |
| 2-2112-DR-2 | 45 | 2-2336-DR | 44 | 2-2748-DR-2 | 28 | 20-232-11-2 | 56 |
| 2-2143-DR-2 | 45 | 2-2340-LU | 81 | 2-2753-DR-2 | 49 | 20-239-30-2 | 56 |
| 2-2197-FD-2 | 61 | 2-2340-LU-1 | 81 | 2-2758-HI-2 | 73 | 20-239-31-2 | 56 |
| 2-2197-ND | 106 | 2-2345-DR-1 | 38 | 2-2770-NK | 94 | 20-239-32-2 | 56 |
| 2-2200-DR-2 | 45 | 2-2347-DR-1 | 38 | 2-2773-ND | 111 | 20-244-30-2 | 56 |
| 2-2203-ND | 106 | 2-2348-DR | 38 | 2-2774-ND | 111 | 20-244-31-2 | 57 |
| 2-2206-DR-1 | 35 | 2-2349-DR | 38 | 2-2784-ND-2 | 111 | 20-412 | 75 |
| 2-2207-DR-1 | 35 | 2-2349-DR-1 | 38 | 2-2822-DR | 40 | 20-501-1 | 73 |
| 2-2211-DR-2 | 45 | 2-2350-DR | 39 | 2-2823-DR | 40 | 20-502-1 | 74 |
| 2-2215-FD | 61 | 2-2350-DR-2 | 38 | 2-2824-MI | 92 | 20-504-1 | 74 |
| 2-2218-FD | 64 | 2-2352-DR-1 | 39 | 2-2828-NK | 94 | 20-601 | 111 |
| 2-2220-MI | 90 | 2-2353-DR-1 | 39 | 2-2886-ND | 111 | 20-1105-41 | 28 |
| 2-2222-ND | 106 | 2-2355-BO | 8 | 2-2899-DR | 40 | 20-1132-12-1 | 24 |
| 2-2223-ND | 106 | 2-2355-BO-1 | 8 | 3-1005-01LU | 77 | 20-1132-22-1 | 25 |
| 2-2224-ND | 106 | 2-2356-ND-1 | 108 | 3-1021-FD | 60 | 20-1132-33-1 | 25 |
| 2-2226-ND | 107 | 2-2357-DR-1 | 34 | 20-101-1 | 9 | 20-1138-11-1 | 25 |
| 2-2227-MI | 91 | 2-2362-BO | 8 | 20-102-1 | 10 | 20-1142-31-1 | 25 |
| 2-2227-MI-2 | 91 | 2-2364-DR | 39 | 20-102-5 | 10 | 20-1156-21 | 28 |
| 2-2228-MI | 91 | 2-2366-DR | 39 | 20-104-1 | 10 | 20-1163-1 | 19 |
| 2-2229-MI | 91 | 2-2367-DR | 39 | 20-110-2 | 10 | 20-9900 | 49 |
| 2-2230-HI | 71 | 2-2372-DR | 37 | 20-113-1 | 10 | 50-100-1 | 40 |
| 2-2231-HI | 71 | 2-2375-DR | 37 | 20-116-1 | 10 | 50-100-2 | 40 |
| 2-2232-ND | 107 | 2-2375-DR-1 | 37 | 20-117-1 | 11 | 50-103-1 | 41 |
| 2-2233-HI | 71 | 2-2377-DR | 37 | 20-118-1 | 11 | 50-103-2 | 40 |
| 2-2234-ND | 107 | 2-2377-DR-1 | 37 | 20-119-1 | 16 | 50-104-1 | 41 |
| 2-2235-HI | 71 | 2-2379-DR | 37 | 20-121-1 | 16 | 50-104-2 | 41 |
| 2-2238-ND | 107 | 2-2389-DR | 34 | 20-124-1 | 17 | 50-108-1 | 41 |
| 2-2239-ND | 107 | 2-2391-DR | 34 | 20-125-1 | 17 | 50-108-2 | 41 |
| 2-2263-ND | 107 | 2-2455-ND | 108 | 20-126-1 | 18 | 50-111 | 43 |
| 2-2264-HI | 72 | 2-2458-LU | 81 | 20-127-1 | 18 | 50-111-1 | 43 |
| 2-2265-ND | 108 | 2-2458-LU-1 | 81 | 20-131-1 | 18 | 50-113-1 | 35 |
| 2-2276-ND | 101 | 2-2459-LU | 81 | 20-132-1 | 18 | 50-150-1 | 42 |
| 2-2277-ND | 101 | 2-2463-BO | 8 | 20-133-1 | 18 | 50-150-2 | 42 |
| 2-2279-ND | 101 | 2-2470-DR | 35 | 20-142-11-1 | 22 | 50-151-1 | 42 |
| 2-2280-ND | 101 | 2-2471-DR | 41 | 20-142-32-1 | 22 | 50-151-2 | 42 |
| 2-2281-LU | 79 | 2-2472-DR | 41 | 20-145-11-1 | 23 | 50-151-3 | 42 |
| 2-2281-LU-1 | 79 | 2-2473-DR | 43 | 20-145-21-1 | 23 | 50-152-1 | 42 |
| 2-2282-LU | 80 | 2-2474-DR | 43 | 20-145-31-1 | 23 | 50-152-2 | 42 |
| 2-2283-BO | 4 | 2-2548-ND | 108 | 20-152-11-1 | 23 | 50-153-1 | 43 |
| 2-2284-BO | 4 | 2-2553-BO | 8 | 20-152-22-1 | 23 | 50-153-2 | 43 |
| 2-2285-BO | 4 | 2-2569-MI | 93 | 20-152-31-1 | 24 | 50-157-9 | 28 |
| 2-2286-DR | 43 | 2-2596-DR-2 | 49 | 20-152-32-1 | 24 | 50-158-1 | 36 |
| 2-2287-DR | 44 | 2-2638 | 93 | 20-175-11 | 27 | 50-159-1 | 36 |
| 2-2288-FD | 61 | 2-2652-MI | 91 | 20-178-1 | 17 | 50-160-1 | 36 |
| 2-2289-FD | 61 | 2-2655-ND | 109 | 20-184-32 | 24 | 50-161-1 | 36 |
| 2-2290-LU | 80 | 2-2656-ND | 109 | 20-189-11-1 | 24 | 50-162-1 | 36 |
| 2-2291-LU | 80 | 2-2660-ND | 109 | 20-202 | 49 | 50-192-1 | 43 |
| 2-2292-LU | 80 | 2-2666 | 109 | 20-207-30-1 | 51 | 50-192-2 | 43 |
| 2-2292-LU-1 | 80 | 2-2669-BO | 5 | 20-207-31-2 | 50 | 50-193-1 | 36 |
| 2-2293-LU | 80 | 2-2675-DR | 42 | 20-208-30-1 | 51 | 50-194-1 | 37 |
| 2-2294-VA | 112 | 2-2680-BO | 5 | 20-209-9 | 50 | 50-220-1 | 64 |
| 2-2295-LU | 78 | 2-2686-LU | 79 | 20-210-1 | 50 | 50-237-1 | 64 |
| 2-2295-LU-1 | 78 | 2-2687-LU | 81 | 20-216-10 | 50 | 50-8402-2 | 29 |
| 2-2296-LU | 78 | 2-2690-BO | 9 | 20-216-30 | 50 | 50-8403 | 29 |
| 2-2297-BO | 4 | 2-2697-MI | 93 | 20-219-10 | 51 | 50-8404 | 29 |
| 2-2298-BO | 4 | 2-2698-MI | 93 | 20-220-10 | 51 | 50-8405 | 29 |
| 2-2299-BO | 5 | 2-2703-DR | 42 | 20-220-30 | 51 | 50-8406-2 | 30 |
| 2-2300-LU | 78 | 2-2704-DR-2 | 34 | 20-221-10-2 | 52 | 50-8407 | 30 |
| 2-2300-LU-1 | 78 | 2-2705-ND-2 | 109 | 20-221-11-2 | 52 | 50-8410 | 30 |
| 2-2301-LU | 78 | 2-2706-MI | 86 | 20-221-12-2 | 52 | 50-8415 | 30 |
| 2-2302-LU | 79 | 2-2707-BO-2 | 5 | 20-225-11-2 | 53 | 50-8417 | 30 |
| 2-2302-LU-1 | 79 | 2-2708-ND-2 | 109 | 20-226-10-2 | 53 | 50-8418 | 30 |
| 2-2303-LU | 80 | 2-2709-ND-2 | 110 | 20-226-11-2 | 53 | 50-8419 | 31 |
| 2-2304-LU | 81 | 2-2710-ND-2 | 101 | 20-226-12-2 | 53 | 50-8420 | 31 |
| 2-2304-LU-1 | 81 | 2-2715-HI-2 | 73 | 20-226-13-2 | 53 | 50-8421 | 31 |
| 2-2305-LU | 79 | 2-2722-ND-2 | 110 | 20-227-30-2 | 54 | 50-8422 | 31 |
| 2-2306-MD | 83 | 2-2725-MI | 93 | 20-228-10-2 | 54 | 50-8423 | 31 |
| 2-2307-MD | 83 | 2-2726-ND-2 | 110 | 20-228-11-2 | 54 | 50-8424 | 31 |
| 2-2308-MD | 83 | 2-2729-NK-2 | 94 | 20-228-12-2 | 54 | 50-8425 | 32 |
| 2-2311-HI | 72 | 2-2730-NK-2 | 94 | 20-228-13-2 | 54 | 50-8426 | 32 |

NUMERICAL INDEX

NUMERICAL INDEX - CATALOG# to PAGE#

| Catalog# | Page | Catalog# | Page | Catalog# | Page | Catalog# | Page |
|-----------|------|----------|------|----------|------|----------|------|
| 50-8428 | 32 | 82-7861 | 118 | | | | |
| 50-8429 | 32 | 82-7862 | 123 | | | | |
| 50-8431 | 32 | 82-7871 | 123 | | | | |
| 50-8432 | 32 | | | | | | |
| 50-8433 | 33 | | | | | | |
| 50-8434 | 33 | | | | | | |
| 50-8436 | 33 | | | | | | |
| 50-8437 | 33 | | | | | | |
| 50-8438 | 33 | | | | | | |
| 50-8441 | 33 | | | | | | |
| 50-9100-1 | 5 | | | | | | |
| 50-9101-1 | 6 | | | | | | |
| 50-9102 | 6 | | | | | | |
| 50-9105-1 | 6 | | | | | | |
| 50-9107 | 6 | | | | | | |
| 50-9108 | 6 | | | | | | |
| 50-9109-1 | 6 | | | | | | |
| 50-9110-1 | 7 | | | | | | |
| 50-9115 | 7 | | | | | | |
| 50-9117 | 7 | | | | | | |
| 50-9122-1 | 7 | | | | | | |
| 50-9124-1 | 7 | | | | | | |
| 50-9200 | 82 | | | | | | |
| 50-9200-1 | 82 | | | | | | |
| 50-9200-2 | 82 | | | | | | |
| 50-9202 | 79 | | | | | | |
| 50-9900 | 49 | | | | | | |
| 82-6852 | 119 | | | | | | |
| 82-6852-1 | 119 | | | | | | |
| 82-6853 | 120 | | | | | | |
| 82-6854 | 113 | | | | | | |
| 82-6854-1 | 113 | | | | | | |
| 82-6855 | 113 | | | | | | |
| 82-6858 | 121 | | | | | | |
| 82-6859 | 114 | | | | | | |
| 82-6860 | 114 | | | | | | |
| 82-6860-1 | 114 | | | | | | |
| 82-6860-2 | 114 | | | | | | |
| 82-6860-3 | 114 | | | | | | |
| 82-6861 | 114 | | | | | | |
| 82-6862 | 115 | | | | | | |
| 82-6863 | 115 | | | | | | |
| 82-6864 | 115 | | | | | | |
| 82-6865 | 121 | | | | | | |
| 82-6866 | 121 | | | | | | |
| 82-6867 | 121 | | | | | | |
| 82-6867-1 | 121 | | | | | | |
| 82-6868-1 | 121 | | | | | | |
| 82-6868-2 | 122 | | | | | | |
| 82-6868-3 | 122 | | | | | | |
| 82-6869 | 115 | | | | | | |
| 82-6869-1 | 115 | | | | | | |
| 82-6870 | 116 | | | | | | |
| 82-6871-1 | 116 | | | | | | |
| 82-6872-1 | 113 | | | | | | |
| 82-6873 | 116 | | | | | | |
| 82-6874 | 116 | | | | | | |
| 82-6875 | 118 | | | | | | |
| 82-6876 | 118 | | | | | | |
| 82-6877 | 118 | | | | | | |
| 82-6878 | 119 | | | | | | |
| 82-6879 | 117 | | | | | | |
| 82-6880 | 117 | | | | | | |
| 82-6881 | 122 | | | | | | |
| 82-6882 | 120 | | | | | | |
| 82-6884 | 122 | | | | | | |
| 82-6885 | 117 | | | | | | |
| 82-6886 | 119 | | | | | | |
| 82-6887 | 117 | | | | | | |
| 82-6888 | 117 | | | | | | |
| 82-6889 | 120 | | | | | | |
| 82-6890 | 122 | | | | | | |
| 82-7850 | 120 | | | | | | |
| 82-7851 | 118 | | | | | | |
| 82-7852 | 120 | | | | | | |
| 82-7859 | 120 | | | | | | |
| 82-7860 | 118 | | | | | | |

NUMERICAL INDEX

CS130, CS130D SERIES ALTERNATOR FEATURES

- 100% New
- OE performance output curve
- OE interchangeable components, officially licensed & manufactured with Remy's patent-protected technology
- WAI-Transpo premium rectifier featuring press-fit avalanche diodes
- WAI-Transpo heavy duty ASVR regulator featuring high-temp reliability & increased field life
- Premium, hi-temperature WBD bearings. CS130 series features large 6303 D.E. bearing; extra wide 62000 S.R.E. bearing.
- Hi-temperature Class-H Windings
- Precision CNC Machined Castings



PG260M SERIES STARTER FEATURES

- 100% New
- OE performance torque & output
- OE interchangeable components, officially licensed & manufactured with Remy's patent-protected technology
- Hi-performance rare earth magnets are completely sealed from moisture & contaminants
- Field case assys. are 100% tested on a computerized gaussmeter to measure magnet strength & position.
- Zinc plated field case, solenoid, C.E. cover & hardware
- Armatures are precision balanced & feature banded hairpins
- Commutators are stake-welded & polished for longer brush life
- Carbon brushes are welded - same as OE
- Starter, drive & solenoid are endurance tested



REMY'S PATENT-PROTECTED TECHNOLOGY



Look for the above sticker as assurance that you are getting CS130, CS130D alternators & PG260M starters manufactured with Remy's patent-protected technology.



FARM, INDUSTRIAL & TRUCK

Distributed by:

